



LEARN. GROW. ACHIEVE.

**GENERAL CATALOG &
STUDENT HANDBOOK
2006-2007**

480.423.6100
www.scottsdalecc.edu



2006-2007 ACADEMIC CALENDAR

Summer I and II Sessions - 2006

Registration — Consult the Summer Class Schedule for registration and drop/add information.

Observance of Memorial Day (Campus Closed)	Monday	... May 29
First 5-week/8-week Sessions Begin	Tuesday	... May 30
Schedule Adjustments, First 5- and 8-week Sessions	Tuesday–Wednesday	... May 30-31
First 5-week Session Ends	Thursday	... June 29
Observance of Independence Day (Campus Closed).....	Tuesday	... July 4
Second 5-week Session Begins	Wednesday	... July 5
Schedule Adjustments, Second 5-week Session	Wednesday–Thursday	... July 5-6
8-week Session Ends	Thursday	... July 20
Second 5-week Session Ends	Thursday	... August 3

Fall Semester - 2006

Registration — Consult the Fall Class Schedule for registration and drop/add information.

Saturday Classes Begin	Saturday	... August 19
Day/Evening Classes Begin	Monday	... August 21
Observance of Labor Day (Campus Closed)	Monday	... September 4
Last Day to File Application for December 2006 Graduation	Friday	... October 6
Last Day for Student Withdrawal Without Instructor's Signature	Friday	... October 6
Observance of Veterans' Day (Campus Closed)	Friday	... November 10
Thanksgiving Recess (Campus Closed)	Thursday–Sunday	... November 23–26
Last Day for Student Withdrawal With Instructor's Signature	Monday	... November 27
Last Day of Regular Classes	Sunday	... December 10
Final Exams	Monday–Thursday	... December 11–14
Mid-Year Recess Begins for Students	Friday	... December 15
Fall Semester Ends	Friday	... December 15

Spring Semester - 2007

Registration — Consult the Spring Class Schedule for registration and drop/add information.

Saturday Classes Begin	Saturday	... January 13
Observance of M. L. King Birthday (Campus Closed)	Monday	... January 15
Day/Evening Classes Begin	Tuesday	... January 16
Observance of Presidents' Day (Campus Closed).....	Monday	... February 19
North Central Accreditation Visit (Campus Closed)	Monday–Wednesday	... February 26–28
Last Day to File Application for May 2007 Graduation	Friday	... March 2
Last Day for Student Withdrawal Without Instructor's Signature	Friday	... March 2
Spring Break (Campus Closed <i>March 15-18</i>)	Monday–Sunday	... March 12–18
Last Day for Student Withdrawal With Instructor's Signature	Monday	... April 23
Last Day of Regular Classes	Sunday	... May 6
Final Exams	Monday–Thursday	... May 7–10
Commencement	Friday	... May 11
Spring Semester Ends	Friday	... May 11

Summer I and II Sessions - 2007 (Subject to 2007-2008 Catalog)

Registration — Consult the Summer Class Schedule for registration and drop/add information.

Observance of Memorial Day (Campus Closed).	Monday	... May 28
First 5-week/8-week Sessions Begin	Tuesday	... May 29
Schedule Adjustments, First 5- and 8-week Sessions	Tuesday–Wednesday	... May 29-30
First 5-week Session Ends	Thursday	... June 28
Second 5-week Session Begins	Monday	... July 2
Schedule Adjustments, Second 5-week Session	Monday–Tuesday	... July 2-3
Observance of Independence Day (Campus Closed).....	Wednesday	... July 4
8-week Session Ends	Thursday	... July 19
Second 5-week Session Ends	Thursday	... August 2

SCOTTSDALE COMMUNITY COLLEGE

2006-2007 GENERAL CATALOG AND STUDENT HANDBOOK

9000 East Chaparral Road
Telephone 480.423.6000

Scottsdale, Arizona 85256-2626
Website: www.scottsdalecc.edu

Mission of Scottsdale Community College

The mission of Scottsdale Community College is to create accessible, effective, and affordable environments for teaching and learning for the people of our communities in order that they may grow personally and become productive citizens in a changing and multicultural world.

Scottsdale Community College is committed to offering:

General Education, enabling all students to exercise their obligations and privileges as citizens with intelligence and informed judgment.

University Transfer Education, enabling transfer to public and private four-year colleges and universities.

Occupational Education, providing job training, retraining and upgrading of skills through courses, internships and certificate and degree programs.

Basic Skills Education, preparing students for access to post-secondary education through remedial and developmental education.

Student Development and Support Services, providing a broad range of services to enable students to develop and achieve educational, personal, and career goals.

Continuing Education and Community Service, providing enrichment opportunities for lifelong learning through credit and non-credit courses, workshops, seminars, forums and cultural programs.

Cultural Education, supporting opportunities to experience and participate in the fine arts.

Scottsdale Community College is accredited by:

North Central Association of Colleges and Schools
The Higher Learning Commission
30 North LaSalle St., Suite 2400
Chicago, IL 60602
Phone: 312-263-0456 or 800-621-7440
FAX: 312-263-7462

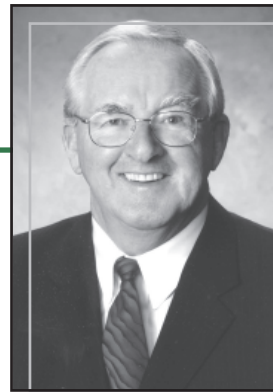

A message from the President,

Welcome to Scottsdale Community College. We are very pleased you are considering attending our College.

The S.C.C. catalog will provide you with information for admission to the College, advisement about programs, student support services and programs and public service programs for the entire community and service area.

We have a great academic tradition and our students have an outstanding history of achievement. We maintain many and varied programs and activities to meet the needs of community college students.

The College staff is dedicated, talented and willing to answer any and all of the questions you may have. Please don't hesitate to call the College for assistance.

On behalf of Scottsdale Community College, best wishes in your collegiate endeavors.

Sincerely,

A handwritten signature in black ink, which appears to read "Arthur W. DeCabooter". The signature is written in a cursive style.

Arthur W. DeCabooter
President

TABLE OF CONTENTS

Academic Calendar	Inside Cover	Adult Re-Entry Services	207
General Information		Advisement Center	207
Accreditation and Mission Statements	1	American Indian Program	207
SCC Program/Degree Index	3	Bursar/Cashier's Office	207
Instructional Divisions	4	Bus Service	207
Maricopa Colleges	5	Career & Cooperative Education Services	208
Scottsdale Community College Offices/Websites	5	Child Enrichment Center	208
Nondiscrimination Policy	6	Clubs/Organizations for Students	208
Equal Opportunity Statement	6	Counseling Services	208
Affirmative Action Policy Statements	6	Culinary Arts Dining Room	209
Maricopa Vision, Mission and Value Statements	8	Disability Resources and Services	209
Maricopa Community Colleges General Regulations	8	Facility Requests	209
Admission/Registration/Enrollment		Financial Aid	209
Admission Policy/Classifications	9	Food Services	209
Admission Information/Residency Guidelines	10	Honors Program	209
Other Admission Information	13	Housing	209
Credit for Prior Learning	13	International Education Programs	210
Student Course Placement	21	Library Services	210
Academic Advising	21	Mailboxes	210
Registration	22	Maricopa Online Student System	210
Emissions Control Compliance	22	Meeting and Conference Rooms	210
Transcripts for Transfer	22	Men's Athletics	210
Tuition and Fees	22	Open Computer Lab	210
Refund Policy	24	Orientation and Campus Tours	210
Student Financial Assistance	25	Psi Gamma Chapter of Phi Theta Kappa	210
Veterans Services	26	Senior Adult Education Program	211
Scholastic Standards		Student Accident Insurance	211
Academic Load	27	Student Life & Leadership - Programs & Services	211
Schedule Changes/Attendance/Grading	27	Student Leadership Forum	211
Academic Probation (Progress)	28	Testing Center	211
Important Deadlines for Students	29	Tutoring Services	212
Instructional Grievance Process	30	Veterans Services	212
Non-Instructional Complaint Resolution Process	30	Volunteerism	212
Withdrawal/Withdrawal Procedures	31	Voter Registration	212
Academic Renewal	32	Women's Athletics	212
Honors Program	32	Student Life & Leadership Events Calendar	213
President's Honor List	32	Campus Policies	214
Graduation		College Environment	
MCCCD Arizona General Education Curriculum (AGEC)	33	Discrimination Complaint Procedures for Students	215
AGEC Course Matrix	36	Sexual Harassment Policy	218
Associate in Arts (AA)	41	Petition Signature Solicitation	219
Associate in Arts Elementary Education (AAEE)	43	Solicitation	219
Associate in Arts Fine Arts - Dance (AAFA - Dance)	45	Children on Campus	220
Associate in Arts Fine Arts - Art (AAFA - Art)	47	Crime Awareness and Campus Security Act	220
Associate in Arts Fine Arts - Theatre (AAFA - Theatre)	49	Workplace Violence Prevention	220
Associate in Science (AS)	51	Student Right to Know	220
Associate in Business, General Requirements (ABus-GR)	53	Student Rights and Responsibilities	
Associate in Business, Special Requirements (ABus-SR)	55	Copyright Act Compliance	221
Associate in Transfer Partnership (ATP) Degree	57	Technology Resource Standards	222
Associate in General Studies (AGS) Degree	58	Hazing Prevention Regulation	223
Associate in Applied Science (AAS) Degree	60	Abuse-Free Environment	224
Academic Certificate (AC)	61	Disability Resources & Services - Eligibility for Accommodations and Required Disability Documentation	227
General Graduation Requirements	62	Academic Misconduct	229
Catalog Under Which a Student Graduates	64	Disciplinary Standards	229
Teacher Education MCCCD District-Wide Offerings	65	Student Disciplinary Code	230
Occupational Programs of MCCCD	69	Student Records	233
Programs (see program index page 3)	73-116	Student Employment	234
Course Descriptions		Student Governance	235
Course Index by Prefix	117	Governing Board/Administration/Management	237
Course Descriptions	118-206	Faculty	238
STUDENT HANDBOOK		Faculty and Administration Emeritus	242
Student Services		Index	243 - 248
Admissions and Records Office	207	Scottsdale College Campus Map	Inside Back Cover
		Scottsdale Area Map	Back Cover

The Maricopa Community Colleges reserve the right to change, without notice, any materials, information, curriculum, requirements, and regulations published in this catalog.

SCC EDUCATIONAL PROGRAMS/DEGREES INDEX

Certificates of Completion

Advanced Professional Culinary Arts	87
Architectural Technology	75
Audio Production Technologies	108
Bookkeeping	79
Broadcast Production	106
Building Safety Technology	76
Business (FASTRACK)	77
Computer Hardware and Network Support	80
Computer Information Systems	81
Crime Scene Investigation	73
Crime Scene Technology	73
Culinary Arts	86
Dance Technology	88
Database Development	80
Early Childhood Development	89
Editing	107
Emergency Medical Technology (Paramedic), Advanced	90
Emergency Medical Technology, Basic	90
Equine Science	91
Film Analysis and Criticism	107
Film Production	107
Fire Academy	93
Fire Science Technology	93
Graphic Design	94
Hospitality and Tourism/Golf Management	97
Hospitality and Tourism/Hotel Management	98
Hospitality and Tourism/Restaurant Management	99
Infant/Toddler Development	100
Interior Design: Professional Level	101
Journalism	101
Justice Studies	73
Management	79
Marketing	79
Microsoft Applications Development	104
Microsoft Desktop Support Technology	102
Microsoft Product Specialist	102
Microsoft Systems Administration	102
Microsoft Systems Engineer	102
Music Business	108
Network Administration	82
Nurse Assisting	110
Office Automation Systems	112
Office Fundamentals	111
Parent Education	92
Personal Computer Applications	80
Planning and Development Technology	76
Police Academy Preparation, Level I	73
Practical Nursing	110
Programming and System Analysis	83
Recreation Management	112
Retail Management and Marketing	79
Screenwriting	106
Software Development	81
Small Business Management	79
Strength and Conditioning Personal Trainer	94
Tribal Development	116
Web Design	84
Web Development	85
Word Processing	111
Yoga Instruction	116

Associate in Applied Science Degrees

Administration of Justice Studies	74
Advanced Professional Culinary Arts	87
Architectural Technology	75
Audio Production Technologies	108
Building Safety and Planning Technology	76
Business	
Tracks: Accounting, Management, Marketing,	
Retail Management and Marketing, or	
Small Business Management	78
Business (FASTRACK)	77
Computer Information Systems	81
Culinary Arts	86
Dance Technology	88
Early Childhood Development	89
Emergency Medical Technology (Paramedic), Advanced	90
Equine Science	91
Family Life Education	92
Fire Science Technology	93
Forensic Science: Crime Lab	74
Graphic Design	94
Hospitality and Tourism/Golf Management	98
Hospitality and Tourism/Hotel Management	98
Hospitality and Tourism/Restaurant Management	99
Interior Design	100
Microsoft Networking Technology	103
Microsoft Applications Development	104
Motion Picture/Television Production	105
Music Business	108
Network Administration	82
Nursing	110
Office Automation Systems	112
Programming and System Analysis	83
Recreation Management	112
Retail Management (Districtwide Program)	114
Tribal Development	116
Web Design	84
Web Development	85

Information on Programs of Study

American Indian Arts Institute (AIAI)	75
Computer Science	85
Engineering Science	91
Health Care Integrated Educational System (HCIES)	95
Health, Physical Education, Recreation and Dance	97
Post-Baccalaureate Teacher Certification Immersion Program	115
Theatre Arts	115

INSTRUCTIONAL DIVISIONS

Applied Sciences

- CHAIR:** Myron Brower 480-423-6229
- AES - Aerospace Studies
 - AET - Aeronautics
 - AJS - Administration of Justice Studies
 - ARC - Architectural Technology
 - BLT - Building Safety Technology
 - CET - Civil Engineering Technology
 - DFT - Drafting Technology (*Effective Fall 2006, the DFT prefix will not be used at SCC. See courses listed under the ARC prefix.*)
 - EQS - Equine Science
 - FOR - Forensic Science
 - GTC - General Technology
 - INT - Interior Design
 - MIS - Military Science

Business and Computer Information Systems

- CHAIR:** Ed O'Brien 480-423-6276
- ACC - Accounting
 - BPC - Business-Personal Computers
 - CCT - Corporate Computer Technology
 - CIS - Computer Information Systems
 - CNT - Cisco Networking Technology
 - EPS - Entrepreneurial Studies
 - GBS - Business
 - IBS - International Business
 - MGT - Management
 - MKT - Marketing
 - MST - Microsoft Networking Technology
 - OAS - Office Automation Systems
 - REA - Real Estate
 - SBS - Small Business Management
 - SBU - Society and Business

Counseling

- CHAIR:** Debra Glasper 480-423-6528
- CPD - Counseling and Personal Development

Fine Arts

- CHAIR:** Beth Ells 480-423-6336
- ADA - Advertising Art
 - ARH - Art Humanities
 - ART - Art (Computer, Photographic, Visual)
 - COM - Communication Arts
 - HUM - Humanities
 - LDR - Leadership
 - MHL - Music: History and Literature
 - MTC - Music: Theory and Composition
 - MUC - Music: Commercial and Business
 - MUE - Music: Education
 - MUP - Music: Performance and Private Instruction
 - TCM - Motion Picture/Television Production
 - THE - Theatre Arts
 - THP - Theatre Performance and Production

Health, Physical Education, Recreation and Dance

- CHAIR:** Amy Goff 480-423-6685
- DAH - Dance Humanities
 - DAN - Dance
 - HES - Health Science
 - PED - Physical Education
 - REC - Recreation
 - RES - Respiratory Care
 - WED - Wellness Education

Health Sciences

- CHAIR:** Nellie Nelson 480-423-6232
- EMT - Emergency Medical Technology
 - FSC - Fire Science Technology
 - FON - Food and Nutrition
 - HCC - Health Core Curriculum
 - HCR - Health Care Related
 - NCE - Nursing: Continuing Education
 - NUR - Nursing Science

Hospitality, Tourism, and Culinary Arts

- CHAIR:** Karen Chalmers 480-423-6241
- CUL - Culinary Arts
 - HRM - Hospitality & Tourism Management

Language and Communication

- CHAIR:** Pat Medeiros 480-423-6464
- CRE - Critical Reading
 - ENG - English
 - ENH - English Humanities
 - ESL - English as a Second Language
 - JRN - Journalism
 - MCO - Mass Communication
 - RDG - Reading
 - STO - Storytelling
 - WST - Women's Studies
 - Foreign Languages:
 - CHI - Chinese
 - FRE - French
 - GER - German
 - ITA - Italian
 - JPN - Japanese
 - PIM - Pima
 - SLG - Sign Language
 - SPA - Spanish
 - TRS - Translation/Interpretation

Library Science

- CHAIR:** Patricia Lokey 480-423-6653
- IFS - Information Studies

Mathematics and Sciences

- CHAIR:** Doug Sawyer 480-423-6196
- AGS - Agricultural Science
 - AST - Astronomy
 - BIO - Biology
 - CHM - Chemistry
 - CSC - Computer Science
 - ECE - Engineering Science
 - EEE - Electrical Engineering
 - GLG - Geology
 - MAT - Mathematics
 - PHY - Physics

Social and Behavioral Sciences

- CHAIR:** Jeff Ricker 480-423-6213
- AIS - American Indian Studies
 - ASB - Cultural Anthropology
 - ASM - Anthropology
 - CFS - Child/Family Studies
 - ECH - Early Childhood Development
 - ECN - Economics
 - EDU - Education
 - EED - Early Education
 - FCS - Family and Consumer Science
 - GCU - Geography, Cultural
 - GPH - Geography, Physical
 - HIS - History
 - ITD - Infant/Toddler Development
 - PHI - Philosophy
 - POS - Political Science
 - PSY - Psychology
 - REL - Religious Studies
 - SOC - Sociology

The Maricopa Community Colleges

Chandler-Gilbert Community College	(480) 732-7000 2626 East Pecos Road Chandler, AZ 85225-2499 www.cgc.maricopa.edu
Estrella Mountain Community College	(623) 935-8000 3000 North Dysart Road Avondale, AZ 85323-1000 www.emc.maricopa.edu
GateWay Community College	(602) 286-8000 108 North 40th Street Phoenix, AZ 85034-1795 www.gatewaycc.edu
Glendale Community College	(623) 845-3000 6000 West Olive Avenue Glendale, AZ 85302-3090 www.gc.maricopa.edu
Maricopa Skill Center	(602) 238-4300 1245 East Buckeye Road Phoenix, AZ 85034-4101 http://skillcenter.gatewaycc.edu
Mesa Community College	(480) 461-7000 1833 West Southern Avenue Mesa, AZ 85202-4866 www.mc.maricopa.edu
Paradise Valley Community College	(602) 787-6500 18401 North 32nd Street Phoenix, AZ 85032-1200 www.pvc.maricopa.edu
Phoenix College	(602) 285-7500 1202 West Thomas Road Phoenix, AZ 85013-4234 www.pc.maricopa.edu
Rio Salado College	(480) 517-8000 2323 West 14th Street Tempe, AZ 85281-6941 www.rio.maricopa.edu
Scottsdale Community College	(480) 423-6000 9000 East Chaparral Road Scottsdale, AZ 85256-2626 www.scottsdalecc.edu
South Mountain Community College	(602) 243-8000 7050 South 24th Street Phoenix, AZ 85042 www.southmountaincc.edu
SouthWest Skill Center	(623) 935-8000 3000 North Dysart Road Avondale, AZ 85323 www.emc.maricopa.edu/swsc
Maricopa Community Colleges	(480) 731-8000 District Office 2411 West 14th Street Tempe, AZ 85281-6942 www.maricopa.edu
24-hour Information Line	(480) 731-8333

Websites

Admissions Information	www.scottsdalecc.edu/admissions
American Indian Program	www.scottsdalecc.edu/aip
Bookstore	www.scottsdale.bkstr.com
Campus Map	www.scottsdalecc.edu/sccmap
Catalog	www.scottsdalecc.edu/catalog
Class Schedules	http://scinfo.scottsdalecc.edu/sis/schedule
Cooperative Education Program	www.scottsdalecc.edu/co-op
Financial Aid Information	www.finaid.org
General Information	www.scottsdalecc.edu
Instructional Departments	www.scottsdalecc.edu/departments
International Education Programs	www.scottsdalecc.edu/ied
Library	www.scottsdalecc.edu/library
MCCCD Curriculum	www.maricopa.edu/academic/curric
Student Life & Leadership	www.scottsdalecc.edu/slf
Student Services	www.scottsdalecc.edu/students/services.asp
University Articulation	www.maricopa.edu/academic/artic
Workforce Development	www.scottsdalecc.edu/workforce

SCC Phone Numbers

All Phone Numbers Use Area Code 480.

Activities Office	423-6538
Admissions Information	423-6100
Adult Re-entry Services	423-6562
Advisement Center	423-6539
Alumni/Development	423-6304
American Indian Program	423-6531
Assessment/Testing	423-6433
Bookstore	423-6554
Bursar/Cashier's Office	423-6148
Campus News	423-6417
Career & Cooperative Education Services	423-6523
Child Enrichment Center	423-6429
Computer Lab	423-6261
Continuing Education/Noncredit	423-6313
Counseling	423-6524
Culinary Arts Menu	423-6155
Culinary Arts Reservations	423-6284
Disability Resources and Services	423-6517
Faculty Resource Center	423-6709
Financial Aid Office	423-6549
First Aid (College Safety)	423-6175
Fitness Center	423-6604
Help Desk	423-6274
Honors Program	423-6721
Information Center	423-6000
International Education Programs	423-6590
Lost and Found (College Safety)	423-6175
Math/Science Tutoring Center	423-6145
Media Center	423-6652
Online Classes (ACC, BPC, CIS, MST and OAS classes only)	423-6588
Phone Registration	423-6100
Placement (Student Jobs)	423-6523
Printing Center	423-6645
Public Relations/Marketing	423-6589
Registration Information	423-6100
Senior Adult Education Program	423-6560
Southwest Studies Institute	423-6314
Student Leadership Forum	423-6541
Switchboard	423-6000
Transcript Request Information Line	423-6151
Veterans' Services	423-6515
Writing Center (Tutoring Assistance)	423-6416

MARICOPA COMMUNITY COLLEGE DISTRICT

The following are Administrative Regulations used in managing the day-to-day operations of the Maricopa County Community College District (MCCCD). Administrative Regulations are amended, adopted or deleted as necessary and are subject to a formal approval process. Administrative Regulations are referenced as AR followed by a regulation number, which corresponds with the regulations on the MCCCD web site: http://www.maricopa.edu/gvpolicy/adminregs/adminregs_toc.htm.

Some regulations include reference to Arizona Revised Statutes from the State of Arizona and are noted as A.R.S. followed by a reference number.

General Statement (AR 2.4.1)

The Maricopa Community Colleges are dedicated to providing a healthy, comfortable and educationally productive environment for students, employees and visitors.

Nondiscrimination Policy (AR 2.4.2)

It is the policy of the Maricopa Community Colleges (consisting of Chandler-Gilbert Community College, the District Office, Estrella Mountain Community College, GateWay Community College, Glendale Community College, Maricopa Skill Center, Southwest Skill Center, Mesa Community College, Paradise Valley Community College, Phoenix College, Rio Salado Community College, Scottsdale Community College and South Mountain Community College) to promote equal employment opportunities through a positive continuing program. This means that Maricopa will not discriminate, nor tolerate discrimination, against any applicant or employee because of race, color, religion, gender, sexual orientation, national origin, age, disability, or veteran status. Additionally, it is the policy of the Maricopa Community Colleges to provide an environment for each job applicant and employee that is free from sexual harassment, as well as harassment and intimidation on account of an individual's race, color, religion, gender, sexual orientation, national origin, age, disability, or veteran status.

This nondiscrimination policy covers all aspects of the employment relationship and admission to, access to, and treatment of students in the Maricopa Community Colleges' programs and activities including vocational education. This policy also prohibits discrimination on the basis of sexual orientation in the admission and treatment of students in the Maricopa Community Colleges' programs and activities and in the hiring, treatment, promotion, evaluation and termination of employees.

Póliza De No Discriminación

Es la póliza de los Colegios Comunitarios del Condado de Maricopa (The Maricopa Community Colleges) que consisten del Centro de Apoyo del Distrito, los colegios comunitarios de Chandler-Gilbert, Estrella Mountain, GateWay, Glendale, Mesa, Paradise Valley, Phoenix, Rio Salado, Scottsdale, South Mountain y el Centro de Capacitación de Maricopa, proveer igualdad en las oportunidades de empleo mediante un programa continuo positivo. Esto significa que Maricopa no discriminará o tolerará discriminación en contra de ningún aplicante o empleado debido a su raza, color, religión, sexo, orientación sexual, nacionalidad, edad, incapacidad o por ser veterano incapacitado. Así mismo, es la póliza de los Colegios Comunitarios proveer para cada aplicante y empleado un ambiente libre de acoso sexual como también de acoso e intimidación referente a raza, color, religión, sexo, orientación sexual, nacionalidad, edad o estado de veterano de cualquier individuo.

Esta póliza de no discriminación cubre todos los aspectos de contratación del empleado, ingreso, acceso a, y tratamiento de alumnos en los Colegios Comunitarios de Maricopa los cuáles incluyen también programas de educación vocacional. Esta póliza también prohíbe discriminación en base de orientación sexual en la admisión y tratamiento de estudiantes, en sus programas y actividades y en la contratación, tratamiento, promoción/ascensos, evaluación y despido de empleados.

Equal Opportunity Statement (AR 2.4.3)

It is the policy of the Maricopa Community Colleges to promote equal employment opportunities through a positive continuing program. This means that Maricopa will not discriminate, nor tolerate discrimination, against any applicant or employee because of race, color, religion, gender, sexual orientation, national origin, age, disability, or veteran status. Additionally, it is the policy of the Maricopa Community Colleges to provide an environment for each job applicant and employee that is free from sexual harassment, as well as harassment and intimidation on account of an individual's race, color, religion, gender, sexual orientation, national origin, age, disability, or veteran status.

Declaración De Igualdad De Oportunidad

Es la póliza de los Colegios Comunitarios del Condado de Maricopa proveer igualdad en las oportunidades de empleo mediante un programa continuo positivo. Esto significa que Maricopa no discriminará o tolerará discriminación en contra de ningún aplicante o empleado debido a su raza, color, religión, sexo, orientación sexual, nacionalidad, edad, incapacidad o por ser veterano incapacitado. Agregando, es la póliza de los Colegios Comunitarios proveer para cada aplicante y empleado un ambiente libre de acoso sexual como también de acoso e intimidación referente a la raza, color, religión, sexo, orientación sexual, nacionalidad, edad y condición de veterano de cualquier individuo.

Affirmative Action Statements

I. Affirmative Action Policy Statement for Individuals with Disabilities

In conformance with the provisions of Section 503 of the Rehabilitation Act of 1973, as amended, and the implementing regulations, 41 CFR 60-741.5(a), as amended, Maricopa Community College District will not discriminate, or tolerate discrimination, against any applicant or employee because of physical or mental disability in regard to any position for which the known applicant or employee is qualified. Maricopa agrees to take affirmative action to employ, advance in employment and otherwise treat known qualified individuals with disabilities without regard to their physical or mental disability in all human resources selection and decision practices, such as the following: advertising, benefits, compensation, discipline (including probation, suspension, and/or termination for cause or layoff), employee facilities, performance evaluation, recruitment, social/recreational programs, and training. Maricopa will also continue to administer these practices without regard to race, color, religion, gender, sexual orientation, national origin, age, disability, or veteran status. Additionally, all applicants and employees are protected from coercion, intimidation, interference, or discrimination for filing a complaint or assisting in an investigation under the Act.

II. Affirmative Action Policy Statement for Other Eligible Veterans, Special Disabled Veterans and Vietnam Era Veterans

In conformance with the Vietnam Era Veterans Readjustment Assistance Act of 1974, the Veterans Employment Opportunities Act of 1998, and the implementing regulations, 41 CFR 60-250(k), Maricopa Community College District will not discriminate, or tolerate discrimination, against any applicant or employee because he or she is a special disabled veteran or Vietnam era veteran in regard to any position for which the known applicant or employee is qualified. Maricopa agrees to take affirmative action to employ, advance in employment, and otherwise treat known qualified special disabled veterans and Vietnam era veterans without discrimination based upon their disability or veteran status in all human resources section and decision practices, such as the following: advertising, benefits, compensation, discipline (including probation, suspension, and/or termination for cause or layoff), employee facilities, performance evaluation, recruitment, social/recreational programs, and training. Maricopa will continue to administer these practices without regard to race, color, religion, gender, sexual orientation, national origin, age, disability, or veteran status. Additionally, Maricopa agrees to post all suitable job openings at the local office of the State employment service where the job opening occurs. This includes full-time, temporary greater than three days' duration, and part-time employment. Finally, all applicants and employees are protected from coercion, intimidation, interference, or discrimination for filing a complaint or assisting in an investigation under the Act.

III. Notice of Americans with Disabilities Act (ADA)/Section 504 of the Rehabilitation Act/ Title IX Coordinator

Notice of Americans with Disabilities Act (ADA)/Section 504 of the Rehabilitation Act/Title IX Coordinator: Dean of Student Services, ADA/504 Title IX Coordinator, Scottsdale Community College, 9000 East Chaparral Road, Scottsdale, AZ 85256-2626, (480) 423-6020.

Under the ADA and Section 504, the District and its colleges recognize the obligation to provide overall program accessibility throughout its locations for persons with disabilities. The designated ADA/504 Title IX Coordinator at each college will provide information as to the existence and location of services, activities and facilities that are accessible to and usable by persons with disabilities. Requests for accommodation should be addressed to the coordinator. Likewise, under Title IX, there is an obligation to provide services and program accessibility in a gender-neutral manner.

Students with disabilities may request catalog information in an alternative format from the college ADA/504 Coordinator.

Declaración de Acción Afirmativa

I. Póliza y Declaración de Acción Afirmativa para Individuos con Incapacidades

De acuerdo a lo que provee la Sección 503 de la Ley de Rehabilitación de 1973, como enmienda, y las leyes de implementación, 41 CFR 60-741.5 (a), declara que el Distrito de Colegios Comunitarios de Maricopa no discriminarán o tolerarán discriminación en contra ningún aplicante o empleado debido a su discapacidad/incapacitación física o mental referente a cualquier posición para la cuál el aplicante o empleado ha calificado. Maricopa promete tomar acción afirmativa para emplear, dar ascenso en empleo y tratar a dichos individuos con incapacidades sin hacer incapie

en sus incapacidades físicas o mentales en la selección de recursos humanos y prácticas decisivas como son las siguientes: anuncios, beneficios, compensación, disciplina (incluyendo período de prueba, suspensión, y/o terminación de empleo por causa de paro forzoso), facilidades para empleados, evaluación de trabajo, reclutamiento, programas sociales/recreacionales y entrenamiento. Maricopa continuará llevando a cabo éstas prácticas de no discriminar por razones de raza, color, religión, sexo, orientación sexual, nacionalidad, edad, incapacidad o estado de veterano. Así mismo, todo los aplicantes y empleados estan protegidos en contra de coacción, intimidación, interferencia o discriminación por quejas o por ayudar en una investigación cubierta bajo éste Acto.

II. Declaración de Póliza de Acción Afirmativa para Otros Veteranos Elegibles, Veteranos con Incapacitación Especial y Veteranos de la Era Vietnamita

Conforme a la ley de Reajuste y Asistencia para los Veteranos de la Era Vietnamita de 1974, acta de Oportunidades de Empleo para Veteranos de 1998 y reglamentos de implementación, 41 CFR 60-250(k), el Distrito de Colegios Comunitarios del Condado de Maricopa no discriminará ni tolerará discriminación en contra de ningún aplicante o empleado veterano o veterano de la Era Vietnamita con discapacidad/incapacitación especial referente a cualquier posición la cual dicho aplicante o empleado califique. Maricopa promete aplicar acción afirmativa para emplear, ascender en empleo y tratar a dichos veteranos incapacitados y de la Era Vietnamita que califiquen sin discriminar base a su discapacidad/incapacitación o condición de veterano en todas las áreas de recursos humanos y decisiones como son las siguientes: anuncios, beneficios, compensación, disciplina (incluyendo período de prueba, suspensión, y/o despido por causa o paro forzoso), facilidades para empleados, evaluación de trabajo, reclutamiento, programas sociales/recreacionales y entrenamiento. Maricopa continuará llevando a cabo estas prácticas sin discriminar por razones de raza, color, religión, sexo, orientación sexual, nacionalidad, edad, incapacidad o condición de veterano. Maricopa promete anunciar todas las oportunidades de empleo disponibles en la oficina local del servicio de empleo del Estado donde el empleo esté disponible. Esto incluye empleo de tiempo completo, temporal de más de tres días de duración y empleo de tiempo medio. Finalmente, todos los aplicantes y empleados están protegidos en contra de coacción, intimidación, interferencia o discriminación por quejas o por ayudar en una investigación cubierta sobre este Acto.

III. Notificación del Acta de Americanos con Impedimentos (ADA)/Sección 504 del Acta de Rehabilitación/Coordinador del Título IX

Notificación del Acta de Americanos con Impedimentos (ADA)/Sección 504 del Acta de Reabilitación/Coordinador del Título IX: Dean of Student Services, ADA/504 Title IX Coordinator, Scottsdale Community College, 9000 East Chaparral Road, Scottsdale, AZ 85256-2626, (480) 423-6020.

De acuerdo a ADA y a la sección 504, el distrito y sus colegios reconocen la obligación de proveer acceso a programas en todas sus localidades a personas incapacitadas. El coordinador designado de ADA/504 del Título IX proveerá información tocante a la existencia y localidad de servicios, actividades y facilidades que son accesibles y de utilidad a personas incapacitadas. Solicitudes para acomodación deben ser dirigidas al coordinador. Del mismo modo, bajo el Título IX, hay obligación de proveer acceso a servicios y programas de una manera imparcial segun el género.

Estudiantes incapacitadas pueden solicitar información de catálogo en una forma diferente por medio del Coordinador designado por ADA/504 en cada colegio.

Maricopa Community Colleges

Vision

A Community of Colleges...Colleges for the Community
... working collectively and responsibly to meet the lifelong learning needs of our diverse students and community.

Mission

The Maricopa Community Colleges provide access to higher education for diverse students and communities. We focus on learning through:

- University Transfer Education
- General Education
- Development Education
- Workforce Development
- Student Development Services
- Continuing Education
- Community Education
- Civic Responsibility
- Global Engagement

Values

The Maricopa Community Colleges are committed to:

Community

We value all people—our students, our employees, their families, and the communities in which they live and work. We value our global community of which we are an integral part.

Excellence

We value excellence and encourage our internal and external communities to strive for their academic professional and personal best.

Honesty and Integrity

We value academic and personal honesty and integrity and believe these elements are essential in our learning environment. We strive to treat each other with respect, civility and fairness.

Inclusiveness

We value inclusiveness and respect for one another. We believe that team work is critical, that each team member is important and we depend on each other to accomplish our mission.

Innovation

We value and embrace an innovative and risk-taking approach so that we remain at the forefront of global educational excellence.

Learning

We value lifelong learning opportunities that respond to the needs of our communities and are accessible, affordable, and of the highest quality. We encourage dialogue and the freedom to have an open exchange of ideas for the common good.

Responsibility

We value responsibility and believe that we are each accountable for our personal and professional actions. We are responsible for making our learning experiences significant and meaningful.

Stewardship

We value stewardship and honor the trust placed in us by the community. We are accountable to our communities for the efficient and effective use of resources as we prepare our students for their role as productive world citizens.

General Regulation (AR 2.1)

A. Compliance with Policies, Rules and Regulations

Every student is expected to know and comply with all current published policies, rules and regulations as printed in the college catalog, class schedule, and/or student handbook. Copies are available at each college.

Policies, courses, programs, fees and requirements may be suspended, deleted, restricted, supplemented or changed through action of the Governing Board of the Maricopa Community Colleges.

The Maricopa Community Colleges reserve the right to change, without notice, any materials, information, curriculum, requirements and regulations.

Note: The regulations that comprise the student section contain language that appears in various sources such as the Catalog Common Pages and the Student Handbook. All areas became Administrative Regulations with the 1996 adoption of the Governance Model. Changes are made annually either through the Administrative Regulations approval process, or by Board approval for those items that fall under its statutory duty, such as Tuition and Fees. In an effort to prevent duplication, topics in this section may be incorporated by reference, as they are featured in other areas of the manual and are noted accordingly.

The Maricopa Community Colleges Vision, Mission and Values that are featured in the Common Pages are a part of approved Governing Board policy and are located in the policy section of the manual. As such, the following statement related to Outcomes Assessment that appears in the Common Pages is presented here as a general statement.

B. Outcomes Assessment

The mission of the Maricopa Community Colleges is to create and continuously improve affordable, accessible, and effective learning environments for the lifelong educational needs of the diverse communities we serve. In order to evaluate how successfully Maricopa Community Colleges accomplish this mission, student outcomes will be assessed as part of the continuous improvement process.

Students may be asked to participate in a variety of assessment activities at each college. Assessment results will be used to improve educational programs, services and student learning.

ADMISSION/REGISTRATION/ENROLLMENT

Admission Policy (AR 2.2.1)

Persons meeting the admissions criteria may attend any Maricopa Community College of their choice. Falsification of any admission materials or official college records may be cause for denial or cancellation of admission. Exceptions to the admissions policies may be requested through the Admissions and Standards Committee.

Admission Classifications

A. Admission of Regular Students

Admission to the community colleges in Arizona may be granted to any person who meets at least one of the following criteria:

1. Is a graduate of a high school, which is accredited by a regional accrediting association as defined by the United States Office of Education or approved by a State Department of Education or other appropriate state educational agency.
2. Has a high school certificate of equivalency.
3. Is 18 years of age or older and demonstrates evidence of potential success in the community college.
4. Is a transfer student in good standing from another college or university.

B. Admission of Students Under 18 Years of Age

1. Admission to the community colleges in Arizona shall be granted to any student who is under age 18 and who achieves the following test scores:
 - a. Scholastic Aptitude Test (SAT) composite (verbal and math)
 - 1) SAT I - 930 or more, **OR**
 - 2) SAT II - 500 or more, **OR** an
 - b. American College Test (ACT) composite of 22 or more.
2. A student shall not be denied admission because of age, lack of a high school diploma or high school certificate of equivalency, grade in school, lack of permission of school officials or lack of concurrent enrollment in a public or private school, if the student has achieved at least the test scores specified in paragraph 1, subparagraphs a or b of this subsection.
3. A student admitted under this subsection is not guaranteed admission to a specific degree program or to all courses offered by the community college.
4. A community college may limit the number of credit hours in which the student may enroll to no fewer than six (6) credit hours.

C. Admission of Students in Special Status

Students not meeting any of the provisions stated above may be admitted on an individual basis with the approval of college officials, so long as the students meet the established requirements of the courses for which they enroll and the college officials determine that such admission is in the best interest of the students.

The status of Special Admissions may be granted to a student who:

1. Is beyond the age of compulsory high school attendance and has met the established requirements for the courses for which he or she plans to enroll based on the college assessment examinations; **OR**
2. Is under the age of 18 and has taken the appropriate college assessment tests in order to demonstrate the knowledge of the necessary academic skill level to benefit from the course. Departments may have additional requirements to register for a course. (Signature of parent or guardian is required for students under 18.); **OR**
3. Is a participant in a special program sponsored by the admitting college.

THE COLLEGES RESERVE THE RIGHT TO ENROLL STUDENTS IN COURSES. The final decision for admission to any class for students admitted under _____ will be determined by the designated college administrator in consultation with the department chairperson.

D. Specialized Vocational/Training Program

If districts are granted authority for specialized curricula, local district boards shall adopt guidelines to determine admissibility of students for such programs.

E. Western Undergraduate Exchange Program

The Western Undergraduate Exchange (WUE) program is a student exchange program coordinated by the Western Interstate Commission for Higher Education (WICHE), and administered by the Arizona Board of Regents. Through WUE, students who reside in western states (Alaska, Arizona, California, Colorado, Hawaii, Idaho, Montana, Nevada, New Mexico, North Dakota, Oregon, South Dakota, Utah, Washington, and Wyoming) and meet the eligibility requirements, pay 150 percent of the regular resident tuition plus fees. Students must mark prominently on the Student Information Form that they seek admission as WUE students. Students may not apply as out-of-state students and expect to receive the WUE tuition rate after admitted. Once admitted as WUE students, students may not petition for in-state residency. Further information may be obtained from the Office of Admissions and Records.

F. Admission of F-1 Nonimmigrant Students

Prospective students should contact the Office of Admissions and Records or designated office for the necessary student information form(s). When completed, the form(s) should be returned to the Office of Admissions and Records or designated office with all requested supporting documents. After the file has been reviewed, a notice will be sent indicating either acceptance or denial of admission.

To be guaranteed consideration for admission, all application materials must be received by July 1 for the fall semester and November 1 for the spring semester.

Prospective students seeking admission based on F-1 nonimmigrant status must provide proof of secondary school with documentation comparable to a United States high school diploma or higher degree. It is recommended that F-1 nonimmigrant students have graduated in the upper 50% of their secondary school (high school or equivalent) in order to ensure success in academic classes at this college. Applicants for admission to the college must have high school and college (if applicable) transcripts sent directly from the high school or college to the Office of Admissions and Records or designated office. In addition, it is the applicant's responsibility to have all transcripts translated into English and evaluated by a foreign credential evaluation service if necessary.

1. Admission to Academic Programs

Applicants who wish to enroll in an academic program at the college must present evidence of English language proficiency. If the Test of English as a Foreign Language (TOEFL) is used to satisfy this requirement, the applicant must attain a score of at least 500 (on the traditional TOEFL) or 173 (on the computer-based test) or 61 (on the internet-based TOEFL, known as the iBT). If the International Language Testing System (IELTS) is used to satisfy this requirement, an IELTS overall Band Score of 5.5 or better is required, and a minimum IELTS individual Band Score of 5.0 on each module is recommended. The dean or director of admission and records of the college may accept other proof of English language proficiency for admission purposes, such as the ASSET test, COMPASS or CELSA tests.

Admission/Registration/Enrollment

Questions about the TOEFL should be directed to the Educational Testing Services at the following address: TOEFL Services, P.O. Box 6151, Princeton, NJ 08543-6151.

2. Admission to the Intensive English Program

An applicant for admission to the Intensive English Program must provide evidence of at least intermediate command of English by way of one or more of the following criteria:

- At least six years of English language instruction as shown by the applicant's school transcript(s);
- A minimum TOEFL score of 400 (on the traditional TOEFL) or 97 (on the computer-based test) or 23 (on the internet-based TOEFL, known as the iBT);
- An original letter of recommendation from a teacher, school principal or headmaster/headmistress, or the director of an English language institute attesting to the applicant's proficiency at the intermediate level;
- Other credentials, test scores, interview results, or evidence accepted by the coordinator of the intensive English program or the college's responsible designee.

Students admitted to the Intensive English Program will not be allowed to enroll in courses outside those officially designated as part of the program unless and until they have met all of the prerequisites or other course requirements.

- Foreign students under certain types of visas may need special permission to enroll and should contact the appropriate college official.

3. Financial Support

Evidence of financial support will be required prior to issuance of the I-20 form. The colleges have no scholarship or financial aid provisions for foreign students; therefore, students must be fully prepared to meet the necessary financial obligations for the full time they will be in the United States. The colleges estimate the student's average costs for 10 months to be:

Tuition and fees:	\$ 6,400 ¹
Living Expenses:	8,700 ²
Books:	800 ³
Health Insurance:	950 ⁴
Total	\$16,850 ⁵

4. Dependent Financial Guarantee

Evidence of financial support for dependents of F-1 students (spouse and dependent children) is also required: \$5,000 for the first dependent and \$2,500 for each additional dependent.

5. Health Insurance

All F-1 students who have an I-20 issued by one of the Maricopa Community Colleges are required to purchase the Maricopa Community Colleges' international student health insurance plan. Health insurance coverage for dependents of F-1 students is highly recommended. The Maricopa Community Colleges contract with an insurance provider annually to offer a health insurance plan for F-1 students. For more information, contact the college office of Admissions and Records or designated international student office.

Footnotes:

¹ Based on 2005-2006 tuition and fee schedule.

² Based on estimated living expenses for two (2) semester (10 months).

³ Based on average new and used textbook prices. Assumes books are sold at the end of the semester.

⁴ Based on 2005-2006 insurance premium for the mandatory Maricopa Community Colleges International Student Health Plan.

⁵ Applicants must provide evidence of this minimum amount of financial support before an I-20 is issued.

Admission Information (AR 2.2.2)

Students must file a Student Information Form with the Office of Admissions and Records at the college of attendance. There is no charge for this service.

A. Student Status

- Freshman** – A student who has completed fewer than 30 credit hours in 100-level courses and above.
- Sophomore** – A student who has completed 30 credit hours or more in 100-level courses and above.
- Unclassified**– A student who has earned an associate degree or higher.

B. Student Identification Number

Disclosure of the social security number is voluntary. (A.R.S. §15-1823) However, students must use social security numbers for reporting information pertaining to potential educational tax credits and for processing federal financial aid applications and Veterans Administration benefits.

C. Declaration of Previous College Attendance

Students who have attended other colleges are required to give the names of those colleges when they apply for admission to one of the Maricopa Community Colleges. If this is not done, enrollment in the college may be canceled.

Transfer students who do not meet the minimum grade point averages listed under Scholastic Standards may be admitted on academic probation.

D. Residency for Tuition Purposes (Appendix A)

All students are classified for tuition purposes under one of the following residency classifications:

- Maricopa County resident
- Out-of-County resident
- Out-of-State resident (including F-1 non-immigrant students)
- Unclassified, Out-of-County/Out-of-State (1-6 credit hours system-wide)

Residency for tuition purposes is determined in accordance with state law (A.R.S. §15-1801 *et. sec.*) and regulations of the Maricopa Community Colleges Governing Board. All of the Maricopa Community Colleges are subject to the above statutes and regulations. Students who have questions about their residency should contact the Office of Admissions and Records for clarification.

Implementation

- Domicile status must be established before the student registers and pays fees. It is the student's responsibility to register under the correct domicile status.
- Enforcement of domicile requirements shall be the responsibility of the Chancellor of the Maricopa Community Colleges. The Chancellor has charged the Director of Admissions and Records, or other designee, at each college to make the initial domicile classification. In determining a student's classification, the college may consider all evidence, written or oral, presented by the student and any other information received from any source which is relevant to determining classification. The college may request written sworn statements or sworn testimony of the student.
- A request for review of the initial classification may be made to a district review committee. The request must be in writing, signed by the student and accompanied by a sworn statement of all facts relevant to the matter. The request must be filed with the admissions officer of the college within ten (10) days of receipt of notification of classification as a non-resident. **Failure to properly file a**

Admission/Registration/Enrollment

request for review within the prescribed time limit constitutes a waiver of review for the current enrollment period. The decision of the review committee shall be final.

Definitions

“Armed Forces of the United States” means the army, the navy, the air force, the marine corps, the coast guard, the commissioned corps of the United States public health services, the national oceanographic and atmospheric association administration, the national guard, and any military reserve unit of any branch of the armed forces of the United States.

“Continuous attendance” means enrollment at one of the Maricopa Community Colleges as a full-time or part-time student for a normal academic year since the beginning of the period for which continuous attendance is claimed. Students need not attend summer sessions or other such intersession beyond the normal academic year in order to maintain continuous attendance.

“County resident” means an individual who has lived in the county for at least fifty (50) days before the first day of classes of the semester.

“Domicile” means a person’s true, fixed, and permanent home and place of habitation. It is the place where he or she intends to remain and to which he or she expects to return when he or she leaves without intending to establish a new domicile elsewhere.

“Emancipated person” means a person who is neither under a legal duty of service to his parent nor entitled to the support of such parent under the laws of this state.

“Full-time student” means one who registers for at least twelve (12) credit hours per semester.

“Part-time student” means one who registers for fewer than twelve (12) credit units per semester.

“Parent” means a person’s father or mother, or if one parent has custody, that parent, or if there is no surviving parent or the whereabouts of the parents are unknown, then a guardian of an unemancipated person if there are not circumstances indicating that such guardianship was created primarily for the purpose of conferring the status of an in-state student on such unemancipated person.

Criteria for Determining Residency

In-State Student Status

- A. Except as otherwise provided in this article, no person having a domicile elsewhere than in this state is eligible for classification as an in-state student for tuition purposes.
- B. A person is not entitled to classification as an in-state student until he or she is domiciled in this state for one year preceding the official starting day of the semester, except that a person whose domicile is in this state is entitled to classification as an in-state student if:
 1. The person’s parent’s domicile is in this state and the parent is allowed to claim him or her as an exemption for state and federal tax purposes.
 2. The person is an employee of an employer which transferred him or her to this state for employment purposes or he or she is the spouse of such employee.
 3. The person is an employee of a school district in this state and is under contract to teach on a full-time basis, or is employed as a full-time non-certified classroom aide, at a school within that school district. For purposes of this paragraph, he or she is eligible for classification as an in-state student only for courses necessary to complete the requirements for certification by the state board of education to teach in a school district in this state. No member of his or her family is eligible for classification as an in-state student if he or she is eligible for classification as an in-state student pursuant to this paragraph.

4. The person’s spouse has established domicile in this state for at least one year and has demonstrated intent and financial independence and is entitled to claim the student as an exemption for state and federal tax purposes or the person’s spouse was temporarily out of state for educational purposes, but maintained a domicile in this state. If the person is a non-citizen, the person must be in an eligible visa status pursuant to federal law to classify as an in-state student for tuition purposes.
- C. The domicile of an unemancipated person is that of such person’s parent.
- D. An unemancipated person who remains in this state when such person’s parent, who had been domiciled in this state, removes from this state is entitled to classification as an in-state student until attainment of the degree for which currently enrolled, as long as such person maintains continuous attendance.
- E. A person who is a member of the armed forces of the United States and who is stationed in this state pursuant to military orders or who is the spouse or a dependent child of a person who is a member of the armed forces of the United States and who is stationed in this state pursuant to military orders is entitled to classification as an in-state student. The student does not lose in-state student classification while in continuous attendance toward the degree for which he or she is currently enrolled.
- F. A person who is a member of the armed forces of the United States or the spouse or a dependent of a member of the armed forces of the United States is entitled to classification as an in-state student if the member of the armed forces has claimed this state as the person’s state of home record for at least twelve (12) consecutive months before the member of the armed forces, spouse or dependent enrolls in a university under the jurisdiction of the Arizona Board of Regents or a community college under jurisdiction of a community college district governing board. For purposes of this subsection, the requirement that a person be domiciled in this state for one (1) year before enrollment to qualify for in-state student classification does not apply.
- G. A person who is honorably discharged from the armed forces of the United States shall be granted immediate classification as an in-state student on honorable discharge from the armed forces and, while in continuous attendance toward the degree for which currently enrolled, does not lose in-state student classification if the person has met all of the following requirements:
 1. Declared Arizona as the person’s legal residence with the person’s branch of service at least one year prior to discharge from the armed forces.
 2. Demonstrated objective evidence of intent to be a resident of Arizona which, for the purposes of this section, include at least one of the following:
 - a. An Arizona driver’s license
 - b. Arizona motor vehicle registration
 - c. Employment history in Arizona
 - d. Arizona voter registration
 - e. Transfer of major banking services to Arizona
 - f. Change of permanent address on all pertinent records
 - g. Other materials of whatever kind or source relevant to domicile or residency status
 3. Filed an Arizona income tax return with the Department of Revenue during the previous tax year.
- H. A person who is a member of an Indian tribe recognized by the United States Department of the Interior whose reservation land lies in the state and extends into another state and who is a resident of the reservation is entitled to classification as an in-state student.

Admission/Registration/Enrollment

Alien In-State Student Status

- A. An alien shall be classified as an in-state student if the alien can establish that on or before the official starting date of the semester the alien meets one of the following situations:
1. Has been domiciled in the state for at least one (1) year immediately preceding the official starting date of the semester.
 2. Is domiciled in this state and:
 - a. The domicile of the alien's parent is in this state; AND
 - b. The parent is entitled to claim the alien as an exemption for federal and state tax purposes.
 3. The alien is domiciled in this state and the alien is:
 - a. An employee of an employer which transferred the alien to this state for employment purposes; OR
 - b. The spouse of such an employee.
 4. Qualifies as an in-state refugee student by virtue of having been granted refugee status in accordance with all applicable laws of the United States and having met all other requirements for domicile in this state.
- B. In establishing domicile, the alien must not hold a visa that prohibits establishing domicile in this state. After meeting other residency requirements, students holding valid, unexpired visas in the following categories may be classified as in-state students:

Visa Type - Description

- A - Foreign Government Official
E - Treaty Trader
G - Principal Resident Representative of Recognized Foreign Member Government to International Staff
K - Fiancé or Child of Fiancé of U.S. Citizen
L - Intracompany Transferee
N - Parent or Child Accorded Special Immigrant Status
O - Workers of Extraordinary Ability in Sciences, Arts, Education, Business, or Athletics
P - Internationally Recognized Entertainers and Athletes, Reciprocal Exchange or Culturally Unique Artists and Entertainers
Q - Cultural Exchange Visitors
V - Spouses and Dependent Children of Lawful Permanent Residents
I-688 - Employment Authorization
- C. Students who hold visas as listed in section B above, or who were issued a visa of a type other than those listed in section B above and have submitted an I-485 to Citizenship and Immigration Services (CIS) or have been out of status for at least one year, may establish domicile by complying with paragraphs A1, A2 or A3 above. In establishing domicile, the alien must be in a status that does not prohibit establishing domicile in this state for at least one year immediately preceding the official starting date of the semester. In the event a student who is not a United States citizen intends to establish domicile under paragraphs A.2.a. (dependent of parent-parent domiciled in Arizona), the student's parent, in order to establish domicile, must hold a valid, unexpired visa in one of the categories listed in paragraph B above. To be eligible to establish domicile, the parent must:
1. Hold a valid visa of a type as listed in paragraph B; OR
 2. Have never held a visa; OR
 3. Have been issued a visa of a type other than those of the foregoing categories but be out of status for at least one year.
- D. A person's status as an undocumented or illegal alien shall not preclude that person from being able to qualify as an in-state student on the same terms as other persons.

- E. An alien is entitled to classification as an in-state refugee student if such person has been granted refugee status in accordance with all applicable laws of the United States and has met all other requirements for domicile.

Presumptions Relating to Student Status

Unless there is evidence to the contrary, the registering authority of the community college or university at which a student is registering will presume that:

- A. No emancipated person has established a domicile in this state while attending any educational institution in this state as a full-time student, as such status is defined by the community college district governing board or the Arizona Board of Regents, in the absence of a clear demonstration to the contrary.
- B. Once established, a domicile is not lost by mere absence unaccompanied by intention to establish a new domicile.
- C. A person who has been domiciled in this state immediately before becoming a member of the armed forces of the United States shall not lose in-state status by reason of such person's presence in any other state or country while a member of the armed forces of the United States.

Proof of Residency

When a student's residency is questioned, the following proof will be required:

A. In-State Residency

1. An affidavit signed by the student must be filed with the person responsible for verifying residency; AND
2. Any of the following may be used in determining a student's domicile in Arizona:
 - a. Income tax report
 - b. Voter registration
 - c. Automobile registration
 - d. Driver's license
 - e. Place of graduation from high school
 - f. Source of financial support
 - g. Dependency as indicated on federal income tax return
 - h. Ownership of real property
 - i. Notarized statement of landlord and/or employer
 - j. Bank accounts
 - k. Other relevant information

B. County Residency

1. An affidavit signed by the student must be filed with the person responsible for verifying domicile to prove continuous residency in a county for fifty (50) days; AND
2. Any of the following may be used to determine a student's county residency:
 - a. Notarized statements of landlord and/or employer
 - b. County voter registration
 - c. Source of financial support
 - d. Place of graduation from high school
 - e. Ownership of real property
 - f. Bank accounts
 - g. Other relevant information

Admission/Registration/Enrollment

Concurrent Enrollment in Arizona Public Institutions of Higher Education (ARS §15-1807) (Appendix C)

It is unlawful for any non-resident student to register concurrently in two or more public institutions of higher education in this state including any university, college or community college for a combined student credit hour enrollment of more than six (6) credit hours without payment of non-resident tuition at one of such institutions.

Any non-resident student desiring to enroll concurrently in two or more public institutions of higher education in this state including any university or community college for a combined total of more than six (6) credit hours who is not subject to non-resident tuition at any of such institutions shall pay the non-resident tuition at the institution of his choice in an amount equivalent to non-resident tuition at such institution for the combined total of credit hours for which the non-resident student is concurrently enrolled.

Other Admission Information (AR 2.2.3)

A. Veterans

By Arizona statute, any failing grades from any Arizona university or community college that were received prior to military service will not be used to determine admission to the community college for the honorably discharged veterans with two (2) years' service in the Armed Forces of the United States. Students admitted or readmitted to the community college under this statute are subject to progression, retention, graduation and other academic regulations and standards. (Also see Appendix G, page 31.)

B. Ability to Benefit – Classifications

Federal guidelines require that students without a high school diploma or certificate of equivalency who are applying for financial aid must demonstrate the ability to benefit. Evaluation during the admission process results in the student being admitted to the college with the status of **REGULAR**, **REGULAR WITH PROVISIONAL REQUIREMENTS** or **SPECIAL**.

REGULAR status, for the purpose of 2.2.3B, is granted to an individual admitted to the college who is a high school graduate or has a GED certificate. A student without a high school diploma or GED certification and beyond the age of compulsory high school attendance may be a regular status student if the student has been assessed to benefit from college instruction by receiving qualifying scores on approved assessment instruments. All regular status students must be pursuing a degree/certificate or be in an eligible program.

REGULAR WITH PROVISIONAL REQUIREMENTS status, for the purpose of 2.2.3B, is granted to a student admitted to the college who is not a high school graduate, does not have a GED certificate, and is beyond the age of compulsory high school attendance, but has been assessed to benefit from college instruction requiring developmental/remedial coursework and is pursuing a degree/certificate or be in an eligible program.

SPECIAL status, for the purpose of 2.2.3B, is granted to a student admitted to the college for concurrent enrollment or pursuing one or more courses of special interest and who meets all the requirements for admission.

C. Transcripts

The Maricopa Community Colleges reserve the right to require transcripts for clarification or admission to specific programs, for participation in official athletic events, and for determination of academic standing and eligibility. When an official transcript is required, the transcript must be sent directly to the college's Office of Admissions and Records. It is the student's responsibility to ensure that transcripts have been received and are complete.

Students entering as high school graduates may be required to submit high school transcripts. Students entering as GED recipients may be required to present a copy of the high school equivalency certificate or an official report of qualifying GED scores.

D. Educational Assessment

All students are encouraged to undergo an educational assessment to determine course placement. Prospective students who do not possess a high school diploma or GED equivalence certificate are required to complete an educational assessment to determine their ability to benefit from college instruction. See Student Assessment and Course Placement Process (AR 2.2.7).

Credit for Prior Learning (AR 2.2.4)

The Maricopa Community Colleges recognize that learning takes place in a variety of situations and circumstances. Many students have significant, demonstrable learning from experiences outside the traditional academic environment. Therefore, prior learning, not life experience, is the basis for the award of college credit.

Students may be awarded no more than 30 credit hours, unless required by a specific program of study, within the Maricopa Community Colleges using one or more of the following assessment methods recommended by the Council for Adult and Experiential Learning (CAEL) and the American Council on Education (ACE): Articulated Programs, Credit by Evaluation, College-Level Equivalency Examinations.

Students must be currently enrolled in a credit course at the college at which they apply for assessment of their prior learning. Credit awarded through prior learning will be posted to a student's transcript upon completion of one or more credit hours (other than by prior learning) at the college granting credit. Exceptions may be granted at some Maricopa Community Colleges for specifically approved programs.

Credit awarded for prior learning does not count as hours in residence for graduation requirements. Exceptions may be granted at some Maricopa Community Colleges for their unique programs of study. No more than 20 semester credit hours may be applied to Arizona General Education Curriculum (AGEC). Credit received through Prior Learning Assessment is transferable within the Maricopa Community Colleges but is not necessarily transferable to other colleges and universities. Therefore, students are strongly advised to meet with a program advisor or contact the college or university they plan to attend.

For further information on Prior Learning Assessment, contact the Office of Admissions and Records.

A. Credit by Evaluation

The Maricopa Community Colleges offer credit by evaluation. The American Council on Education (ACE) evaluates military training and experiences as well as noncollegiate sponsored training programs and recommends credit awards based on this evaluation.

The number of credits listed in the ACE guide are recommendations only. A college is not required to grant a student the number of credits recommended. The credits are included on a student's transcript.

I. Educational Experiences in the Armed Services

The Maricopa Community Colleges may award credit for military experiences based on the *ACE Guide to the Evaluation of Educational Experiences in the Armed Services*. A student may receive college credit if:

- a. Training parallels a discipline area offered through the Maricopa Community Colleges; **AND**
- b. Credit meets a program requirement or is used as elective credit.

Admission/Registration/Enrollment

Upon request by individuals who have successfully completed Basic Training, four (4) credit hours in Physical Education will be awarded as indicated in the ACE Guide and the Community College of the Air Force Catalog. Official documentation of military training is required.

2. College Credit Recommendation Service (CREDIT)

ACE evaluates training programs offered by business, industry, and government and publishes its credit recommendations in *The National Guide to Educational Credit for Training Programs*. If a student has received training which appears in the guide, he or she may receive college credit if:

- a. Training parallels a discipline area offered through the Maricopa Community Colleges; AND
- b. Credit meets a program requirement or is used as elective credit.

3. Departmental Credit by Evaluation

Students may apply for Departmental Credit by Evaluation in certain courses by obtaining the appropriate form in the Office of Admissions and Records and completing applicable paperwork and other requirements of the college, including payment of required fee. See Tuition and Fees Schedule for appropriate fee. Fees are not refundable if a student fails to obtain credit.

Students may not request:

- a. The evaluation of a course a second time;
- b. The evaluation of a course while currently enrolled in the course;
- c. To establish credit in a previously completed course; or
- d. To establish credit for a lower level of a course in which credit has been received.

Certain departments may have additional requirements which must be met before credit may be granted through departmental credit by evaluation.

When credit is granted as outlined above, a notation of credit by evaluation, and the number of credits will appear on the student's transcript. Credit awarded through Credit by Evaluation will be posted to a student's transcript upon completion of one or more credit hours (other than by prior learning) at the college granting the credit. These credits are not used in computing the grade point average. Credit by evaluation is transferable within the Maricopa Community Colleges, but is not necessarily transferable to other colleges and universities.

B. College-Level Equivalency Examinations

ACE has published credit recommendations for a number of national standardized examinations such as the ones listed below in the *Guide to Educational Credit by Examination*.

The Maricopa Community Colleges use these recommendations as guidelines to award credit for equivalent Maricopa Community Colleges coursework as well as elective credit. Scores must be sent directly to the Office of Admissions and Records from the specific testing company(ies) before credit is awarded.

All equivalency is subject to future review and possible catalog change.

I. Advanced Placement Examinations

Students who have taken an advanced placement course of the College Entrance Examination Board (CEEB) in their secondary school and who have taken an Advanced Placement Examination of the CEEB may receive course credit with a score of 3, 4 or 5. Scores must be received directly from CEEB before credit is awarded.

English AP Recommendation:

<u>Exam</u>	<u>Score</u>	<u>Credit Hours/Equivalency</u>
English-Language and Composition	4 or 5	6 credit hrs./ENG101, ENG100AA, AC, AD eligible for Honors ENG102
English-Literature and Composition	4 or 5	6 credit hrs./ENG101, ENH110 eligible for Honors ENG102

Math AP Recommendation:

<u>Exam</u>	<u>Score</u>	<u>Credit for Course</u>
Math-Calculus AB	3, 4 or 5	MAT220 or MAT221
Math-Calculus BC	3	MAT220 or MAT221
Math-Calculus BC	4 or 5	MAT220 or MAT221 and MAT230 or MAT231, upon completion of MAT241
Computer Science A and AB	4 or 5	CSC100

2. College Level Examination Program

The Maricopa Community Colleges may award credit to individuals who have received a score of 500 or more for the 1986 version of the College Level Examination Program (CLEP) General Examinations (610 on the 1978 version) and who meet or exceed the American Council on Education (ACE) recommended scores for awarding credit on the CLEP subject examinations. The ACE credit-granting score recommendation will be 50 (on the 20-80 scale) for all CLEP computer-based exams beginning July 1, 2001. Credit received through CLEP is transferable within the Maricopa Community Colleges, but is not necessarily transferable to other colleges and universities.

Rio Salado College and Paradise Valley Community College are national CLEP test sites. For more information on registering for the CLEP examinations, contact Rio Salado College or Paradise Valley Community College.

English Composition

Students pursuing credit for ENG101 must take the English Composition with Essay. The Maricopa Community Colleges do not award credit for ENG102 through CLEP examination.

Foreign Languages

Credit earned through CLEP examination for French, German, and Spanish meets the language proficiency requirements of the Maricopa Community Colleges.

For CLEP examinations taken prior to July 1, 2001, the Maricopa Community Colleges will grant credit based on the scaled scores indicated below:

<u>Course</u>	<u>Spanish</u>	<u>French</u>	<u>German</u>	<u>Credit</u>
101	40-49	39-48	39-45	4(101)
102	50-54	49-53	46-50	8(101,102)
201	55-61	54-62	51-59	12(101,102,201)
202	62-80	63-80	60-80	16(101,102,201,202)

At the discretion of the individual college, an oral exam at the 202 level may be administered.

Admission/Registration/Enrollment

3. Defense Activity for Non-traditional Education Support Examination Program

The Maricopa Community Colleges may award credit for the Defense Activity for Non-traditional Education Support (DANTES) Examination Program to individuals who meet or exceed the ACE recommended scores for awarding credit on the DANTES subject examinations. The Maricopa Community Colleges do not award credit for ENG102 through DANTES examination. Credit received through DANTES is transferable within the Maricopa Community Colleges, but is not necessarily transferable to other colleges and universities.

The Assessment Center at Rio Salado College is a national test site. For additional information on registering for DANTES examinations, call (480) 517-8560.

4. American College Testing Proficiency Examination Program

The Maricopa Community Colleges may award credit for the American College Testing Proficiency Examination Program (ACT-PEP) based on the scores earned.

5. Departmental Credit by Examination

Students may apply for departmental credit by examination in certain courses by obtaining the appropriate form in the Office of Admissions and Records, paying the required fee, and completing the examination and other requirements of the college. See fee schedule for appropriate fees.

Students may not request:

- a. To challenge a course a second time;
- b. To challenge a course while currently enrolled in the course;
- c. To establish credit in a previously completed course; or
- d. To establish credit for a lower level of a course in which credit has been received.

Certain departments may have additional requirements which must be met before credit may be granted through departmental credit by examination.

Only grades of **A, B, C, D** or **P** earned as a result of this examination will be recorded on the student's transcript. Fees are not refundable after the examination has been administered, regardless of results.

When credit is granted as outlined above, a notation of credit by examination, a grade and the number of credits will appear on the student's transcript. The grade is used in computing the grade point average. Credit awarded through Departmental Credit by Examination will be posted to a student's transcript upon completion of one or more credit hours (other than by prior learning) at the college granting the credit.



Student Center

Admission/Registration/Enrollment

College Level Examination Program (CLEP)			
Examination	MCCCD		
General	Score	Sem. Hrs.	Equivalency
English Composition	50 (7/1/2001 or later) 610 (1986 version) 500 (1978 version)	3	With essay qualifies for ENG101
Humanities	50 (7/1/2001 or later) 500 (prior to 7/1/2001)	6	Elective Credit
Mathematics	50 (7/1/2001 or later) 500 (prior to 7/1/2001)	3	MAT122
Natural Sciences	50 (7/1/2001 or later) 500 (prior to 7/1/2001)	8	Elective Credit*
Social Sciences and History	50 (7/1/2001 or later) 500 (prior to 7/1/2001)	6	Elective Credit
Subject			
Accounting, Principles of	ACE Score	6	ACC Elective Credit
American Government	50	3	POS110
American Literature	ACE Score	6	ENH241, 242
Analyzing and Interpreting Literature	ACE Score	3	Elective Credit
Biology	ACE Score	8	BIO Elective Credit*
Calculus (Calculus with Elem Functions)	ACE Score	4	MAT221
Chemistry	ACE Score	9	CHM Elective Credit*
College Algebra (1993) (replaces College Algebra [1979])	ACE Score	3	MAT152
College Algebra - Trigonometry	ACE Score	3	MAT152
English Literature	ACE Score	3	Elective Credit
French Language	50-54	4	FRE101
French Language	55-61	8	FRE101, 102
French Language	62-65	12	FRE101, 102, 201
French Language	66-80	16	FRE101, 102, 201, 202
Freshman College Composition	ACE Score	3	With Essay ENG101
German Language	39-45	4	GER101
German Language	46-50	8	GER 101, 102
German Language	51-59	12	GER101, 102, 201
German Language	60-80	16	GER101, 102, 201, 202
Human Growth and Development	ACE Score	0	No Credit
Information Systems and Computer Applications	ACE Score	3	CIS Elective Credit
Intro to Educational Psychology	ACE Score	3	EDU Elective
Introductory Business Law	ACE Score	3	GBS Elective Credit
Introductory Psychology	50	3	PSY101
Introductory Sociology	ACE Score	3	SOC101
Mathematics, College	ACE Score	3	MAT142
Macroeconomics, Principles of (replaces Introductory Macroeconomics)	ACE Score	3	ECN111
Management, Principles of	ACE Score	3	MGT Elective Credit
Marketing, Principles of	ACE Score	3	MKT271
Microeconomics, Principles of (replaces Introductory Microeconomics)	ACE Score	3	ECN112
Spanish Language	50-54	4	SPA101
Spanish Language	55-65	8	SPA101, 102
Spanish Language	66-67	12	SPA101, 102, 201
Spanish Language	68-80	16	SPA101, 102, 201, 202
Trigonometry	ACE Score	3	MAT182
U.S. History I - Early Colonization to 1877	ACE Score	3	HIS103
U.S. History II - 1865 to the Present	ACE Score	3	HIS104
Western Civilization I - Ancient Near East to 1648	ACE Score	3	HIS100 or 101
Western Civilization II - 1648 to the Present	ACE Score	3	HIS102

* The general education requirement in natural sciences (SQ & SG) and Literacy and Critical Inquiry (L) are not satisfied by CLEP.

Admission/Registration/Enrollment

Advanced Placement Credit			
Examination	Score	MCCCD	Semester Hrs.
Art - History	5 or 4	ARH101, 102	6
	3	ARH101 or 102	3
Art - Studio - Drawing	5	ART111, ART112	6
	4	ART111	3
Art - Studio - General	5	ART111, 112	6
	4	ART112	3
Biology	5 or 4	BIO181, BIO182	8
	3	BIO100 or Equivalent	4
Chemistry	5 or 4	CHM151/151LL and CHM152/152LL or CHM154/154LL	8 or 9
	3	CHM151, 151LL	4
Computer Science A	5 or 4	CSC100	3
Computer Science AB	5 or 4	CSC100	3
Economics - Introductory Macroeconomics	5 or 4	ECN111	3
Economics - Introductory Microeconomics	5 or 4	ECN112	3
English - Language and Composition	5 or 4	ENG100AA, AC, AD and ENG101	6
English - Literature and Composition	5 or 4	ENG101 and ENH110	6
Environmental Science	5 or 4	No Credit	3
French - Language	5, 4, or 3	FRE101, 102, 201, 202	16
French - Literature	5, 4, or 3	FRE101, 102, 201, 202	16
German - Language	5, 4, or 3	GER101, 102, 201, 202	16
German - Literature	5, 4, or 3	GER101, 102, 201, 202	16
History - American	5 or 4	HIS103, HIS104	6
History - European	5 or 4	HIS101, 102	6
	3		3
Latin - Language	5	LAT101, 102, 201, 202	16
	4	LAT101, 102, 201	12
	3	LAT101, 102	8
Mathematics - Calculus AB	5, 4, or 3	MAT220 or MAT221	4 or 5
Mathematics - Calculus BC	5 or 4	MAT220 or MAT221 and MAT230 or MAT231 upon completion of MAT241	8 to 10
	3	MAT220 or MAT221	4 or 5
Music	5 or 4	MTC105	3
Physics B	5	PHY111, 112	8
Physics C - Electricity and Magnetism	5	PHY116 - with calculus and laboratory course work or PHY112 - with laboratory course work	5
			4
Physics C - Mechanics	5	PHY115 - with calculus and laboratory course work or PHY111 - with laboratory course work	5
			4
Political Science - American Government	5 or 4	POS110	3
Political Science - Comparative Government and Politics	5 or 4	POS140	3
Psychology	5 or 4	PSY101	3
Spanish - Language	5, 4, or 3	SPA101, 102, 201, 202	16
Spanish - Literature	5, 4, or 3	SPA101, 102, 201, 202	16
Statistics	5, 4, or 3	MAT206	3

Admission/Registration/Enrollment

International Baccalaureate Diploma/ Certificate Credit

Students who present an International Baccalaureate Diploma/Certificate may qualify for college credit. Maricopa Community Colleges grant credit for college-level courses only. A grade of 5 qualifies a student to receive credit for one introductory course. No credit is awarded for English B (English as a Second Language). Credit is awarded according to the International Baccalaureate Diploma/Certificate Credit table.

Examination	Score	Semester Hours	Equivalency
Art/Design	7, 6, or 5	6	ART111, 112
	4	3	ART112
Biology	7, 6, or 5	8	BIO181, 182
	4	4	BIO181
Chemistry	7, 6, or 5	9	CHM151, 152
	4	4	CHM151
Economics	7, 6, or 5	6	ECN111, 112
	4	3	ECN111
English A	7, 6, or 5	6	ENG101, ENG100AB, AC, AD
	4	3	ENG100AB, AC, AD
English B	No Credit		None
Foreign Language A or B*	7, 6, or 5	8	Foreign Language 101, 102
	4	4	Foreign Language 101
History - American	7, 6, or 5	6	HIS103, 104
	4	3	HIS103
History - European	7, 6, or 5	6	HIS101, 102
	4	3	HIS101
Mathematics	7, 6, 5, or 4	4	MAT221
Physics	7, 6, or 5	8	PHY111, 112
	4	4	PHY111

Admission/Registration/Enrollment

C. Health Care Integrated Educational System (HCIES) Credit for Prior Learning

National/Regional Credential Recognition

Students who have recognized credentials related to health care may request an evaluation for course competency equivalence on a case-by-case basis through the Integrated Competency Assessment Network (ICAN). For more information contact the ICAN office at (480) 731-8924 or by email at ican@domail.maricopa.edu. Website: <http://healthcare.maricopa.edu/healthcarecourses.php>. When national or regional credentials are determined to be equivalent to the competencies demonstrated in corresponding courses, the recognition of external credentials will fulfill graduation credit requirements for the identified courses through Credit by Evaluation.

Credit by Examination and Credit by Skills Demonstration Assessment

Health care students may apply for credit for prior learning in certain courses. *Specific information and required forms can be found on <http://healthcare.maricopa.edu/healthcarecourses.php>.* Credit by Examination in the HCIES is determined through the use of HCIES Competency Assessment Tests (CATs) and/or Skills Demonstration Assessment under the direction of the HCIES Integrated Competency Assessment Network (ICAN). Students may apply for HCIES Health Care Pathway/Program Advanced Placement in certain courses by obtaining the appropriate form(s) in the Office of Admissions and Records, paying the required fee(s), and successfully completing the examination and/or skills demonstration and other requirements of the college. See fee schedule for appropriate fee. Fees are not refundable if a student fails to obtain credit.

Students may not request:

- To challenge a course a second time;
- To challenge a course while currently enrolled in the course;
- To establish credit in a previously completed course; or
- To establish credit for a lower level of a course in which credit has been received.

Certain health care pathways/programs have additional requirements which must be met before credit may be granted through HCIES credit by examination and credit by skills demonstration assessment.

Grades of **A**, **B**, **C**, **D** or **P**, earned as a result of examination or skills assessment will be recorded on the student's transcript. Fees are not refundable after the examination/skills demonstration has been administered, regardless of results. A grade of **P/Z** is not used in computing the grade point average.

When credit is granted as outlined above, a notation of CREDIT BY EXAMINATION, CREDIT BY EVALUATION or CREDIT BY SKILLS DEMONSTRATION, a grade and the number of credits will appear on the student's transcript. The grade is used in computing the grade point average with the exception of courses graded **P/Z**.

D. Transfer Credit

Students who have had official transcripts sent directly to the Office of Admissions and Records from regionally accredited institutions of higher education may be granted credit for college-level courses in which a **C** (2.0 on a 4.0 scale) or higher grade has been received; but credits accepted in transfer do not necessarily apply to all certificate or degree programs. Regionally accredited institutions of higher education are those that are fully accredited by New England Association of Schools and Colleges, Middle States Association of Colleges and Schools, North Central Association of Colleges and Schools, Northwest Association of Schools and Colleges, Southern Association of Colleges and Schools, and/or the Western Association of Schools and Colleges.

Credits from institutions with candidate status from one of the above regional accrediting associations will be reviewed for transferability by a college committee.

Credits from foreign institutions will be reviewed for acceptance. It is the student's responsibility to have all such transcripts translated into English and evaluated by an International Student Evaluation Service before submitting them to the college.

E. Servicemen's Opportunity College

The Maricopa Community Colleges recognize the unique educational problems confronting many active duty military personnel in attaining their educational goals. The colleges have, therefore, established themselves as Servicemen's Opportunity Colleges. This means that the colleges recognize the peculiar needs of military personnel in that they provide courses on the various military bases located in Maricopa County and provide opportunities to complete courses through non-traditional means when education is interrupted by military obligations. Maricopa Community Colleges maintain liberal entrance requirements, offer maximum credit for educational experiences obtained in the Military Services, and follow residency statutes applicable to the special needs of servicemen. Maricopa Community Colleges follow the recommendations established by the American Council on Education. If, for any reason, Maricopa Community Colleges' status as a Servicemen's Opportunity College District is discontinued, it will nonetheless maintain its commitment to students previously enrolled. In addition, the option to enter into a contract for a degree allows the community college, as the college of record, to grant a degree upon completion of twelve (12) credit hours at the college and the satisfaction of graduation requirements.

F. Transfer Articulation Guidelines (Appendix B)

1. Transfer Articulation with Secondary Institutions, the Maricopa Skill Center, and the Southwest Skill Center

Students who have participated in programs articulated with Maricopa County Community College District (MCCCD) programs may be granted credit for prior learning as provided for in the respective articulation agreements. No fees will be assessed for credits for prior learning granted through articulation. Articulated program credit is transferable within MCCCD, but is not necessarily transferable to other colleges or universities. For proper placement in an articulated program, students should obtain a program of study from an academic advisor. Once the course requirements are completed, students must provide the valid documentation of articulated credits to the Office of Admissions and Records to place the credits on their academic record.

2. Transfer Articulation from Arizona Public Community College Districts and Universities into the Maricopa Community Colleges

Any course that meets general education requirements at any Arizona public community college district or university will be accepted in transfer to meet comparable general education requirements at any of the Maricopa Community Colleges provided the courses were completed with a grade of C or better. Acceptance of courses other than general education requirements is determined by individual Maricopa Community Colleges.

A student transcript with the completed block of courses included in the Arizona General Education Curriculum (AGEC-A, AGECE-B or AGECE-S) will transfer as a block and fulfill the requirements for the corresponding AGECE at the Maricopa Community Colleges.

Admission/Registration/Enrollment

3. Maricopa Community Colleges Transfer Associate Degrees

The Maricopa Community Colleges offer three transfer Associate degrees: Associate in Arts (AA), Associate in Business (ABus), and Associate in Science (AS). Each degree articulates with specific majors offered by Arizona's public universities. In addition, the degrees are recognized and transfer based on articulation agreements with several other baccalaureate degree-granting institutions. The three transfer Associate degrees transfer as a block and include groups or blocks of courses, e.g. the Arizona General Education Curriculum (AGEC), and the Common Lower-Division Courses. Completed blocks are treated as whole; the components are not examined separately to determine transferability. All credits are accepted and applied toward the designated/appropriate baccalaureate degree.

The Maricopa Community Colleges also offer Associate in Transfer Partnership (ATP) Degrees for specific majors at identified public universities. Maricopa's Associate degrees are accessible on the web at the following website:

http://www.maricopa.edu/academic/curric/cphb/hb_programs.php

Select *Academic Programs*

Scroll down to view list of Maricopa's Associate degrees.

4. Transfer Articulation from the Maricopa Community Colleges to Baccalaureate Degree-Granting Institutions

The Maricopa Community Colleges have transfer articulation agreements with private, public, and international baccalaureate degree-granting institutions that have achieved full accreditation or candidacy status with a regional accreditation commission such as the North Central Association of Colleges and Schools. Maricopa Community Colleges transfer articulation agreements are on behalf of the district as a whole and not with individual colleges within the district. Courses taken at any of the Maricopa Community Colleges are equally transferable by institutions wishing to enter into an articulation agreement. Additionally, the articulation agreements require that all Associate Degrees awarded by Maricopa will transfer to participating institutions as a block. As mentioned above, these blocks transfer as a whole.

5. Transfer Options for Maricopa Community Colleges' Associate in Applied Science Degrees

The Maricopa Community Colleges' Associate in Applied Science (AAS) degrees are recommended for students who want to gain a depth of technical expertise leading to employment through the completion of an occupational program. Some students may want to pursue a baccalaureate degree as well. The AAS degrees transfer as a block to the Bachelor of Applied Science at Arizona State University (East and West) and Northern Arizona University.

6. Course Acceptability and Applicability

Transfer articulation to Arizona's public baccalaureate degree-granting institutions is communicated in terms of acceptability and applicability of community college courses and programs.

To determine acceptability of Maricopa Community Colleges courses, refer to the Course Equivalency Guide (CEG) on the Arizona Courses Applicability System (AZCAS). The AZCAS CEG is online at <http://www.az.transfer.org/cas/>. Effective Fall 2000, the course evaluation and/or the general education designation as listed in AZCAS is valid for the term in which credits are earned and appear on the transcript. A course evaluation and/or university general education designation may be subject to change. Given that curriculum is dynamic at both the Maricopa Community Colleges and the institutions to which Maricopa Community College students transfer, students have the option to petition for equivalencies and/or general education designations.

To determine applicability of Maricopa Community Colleges courses and transfer associate degrees to university-specific degree requirements, refer to the Maricopa Community Colleges' Associate in Transfer Partnership degrees, the AZCAS Transfer Planning Aids, or the university transfer guides, described below.

7. University Transfer Guides

Each of Arizona's public universities have developed University Transfer Guides to show how Maricopa Community College courses apply to specific baccalaureate degree requirements. The transfer guides are useful both for students pursuing Associate in Transfer Partnership Degrees, as well as for students who want to transfer to Arizona's public universities to pursue degrees for which the Maricopa Community Colleges do not have Associate in Transfer Partnership Degrees. University Transfer Guides are accessible at the following websites:

Arizona State University Main or East:

<http://www.asu.edu/provost/articulation/>

Arizona State University West:

<http://www.west.asu.edu/tranguid/>

Northern Arizona University:

<http://www4.nau.edu/aio/articulation/tginfo.htm>

The University of Arizona:

<http://transferguides.arizona.edu>

8. Arizona Course Applicability System (AZCAS) Transfer Planning Guides

A student may enter community college or university coursework into AZCAS to create a Transfer Planning Guide. The guide evaluates progress toward completing a community college transfer certificate, transfer degree, and/or an Arizona public university degree and assists students in selecting additional coursework that meets the academic program requirements. The transfer planning guides are accessible at the following website:

<http://www.az.transfer.org/cas/>

Admission/Registration/Enrollment

Student Course Placement Process (AR 2.2.7)

The Maricopa Community Colleges are committed to providing students with opportunities for successful academic experiences. Student academic achievement is directly related to the proper initial course placement. Students are strongly urged to enroll in the courses indicated by their course placement tests. Initial course placement should be discussed with an advisor or counselor who is skilled in assessing the student's needs and factors that affect student success.

A. Testing for Course Placement

1. Students will be required to complete a course placement test under any one of the following conditions:
 - The student is taking his or her first college credit English, reading and/or math course, or any college course for which English, reading or math is a prerequisite.
 - The student is pursuing a degree and does not have current valid district approved course placement scores on file or does not have previous college credit in English, reading and math.
 - The student does not have a high school diploma or GED, and is applying for federal financial aid.
 - The student for whom English is not the primary language and is taking his or her first English as a Second Language class is required to take a test of English proficiency.
2. Students will be strongly encouraged to complete a course placement test under any one of the following conditions:
 - The student is taking a math course and has a college-level prerequisite on file that is more than five (5) years old.
 - The student is taking a college course for which English, reading or math is a prerequisite, and such credit is more than five (5) years old.
3. Students MAY be exempt from a course placement test if at least one of the following conditions apply:
 - The student has earned an associate or higher degree.
 - The student has earned college credits from a regionally accredited college in English, reading, and math with a grade of C or higher, and such credit is no more than five (5) years old.
 - The student has currently valid district approved course placement scores on file.

Note: Being exempt from taking a course placement test does not exempt the student from fulfilling the minimum graduation requirements.

B. Course Placement

- Students will be advised for specific course enrollment based on highest test or retest scores.
- Students with test scores that fall into the range described as a decision zone must receive advisement to select appropriate course(s).
- Students will be permitted one retest in English, reading or by math level after at least a 24-hour waiting period. An additional retest is permitted one year from the date of student's original or retest at any course placement testing site.
- The vice president of student affairs or designee may approve retesting or students with special needs or circumstances. The retest date will then serve as the date of record.
- Students may request a Course Placement Waiver from the appropriate department/division chair or college designee. The signed waiver will be noted on the student's record and will be kept on file in the Office of Admissions and Records.

C. Implementation of Policy

To ensure consistency of the course placement process within the Maricopa Community Colleges:

1. All colleges shall accept the same approved course placement instruments.
2. All colleges shall adhere to the same approved cut-off scores.
3. Course placement scores, with the exception of the reading exemption, will be valid for two years from the date of the original or retest.

Note: The dean of students or designee may approve retesting for students with special needs or circumstances. The retest date will then serve as the date of record.

D. Evaluation

Maricopa Community Colleges will provide an ongoing evaluation of the course placement process. An annual report shall be submitted to the Governing Board to indicate the policy's effectiveness noting the number of students assessed, their placement scores and their success in courses. Every three years a thorough review of the policy and procedures shall be implemented, including recommendations from the English, Reading and Math Instructional Councils regarding cut-off scores.

Academic Advising (AR 2.2.6)

Academic advising assists students in the formation of educational plans and goals. This is an ongoing process of clarification, evaluation, reclarification and re-evaluation.

The ultimate responsibility for making decisions about life goals and educational plans rests with the student. The academic advisor helps to identify and assess alternatives and consequences.

The academic advisor also serves as a resource for accurate information. The advisor is knowledgeable about institutional policies, procedures, programs and resources, and assists students in making use of printed and online materials.

Advisors are in a position to help students identify their learning-related needs. Feedback received from advisors could be beneficial and should be used in policy making decisions at all levels of the institutional administration.

With the help of an academic advisor, students will:

- gain an understanding of their academic abilities and interests.
- be reinforced in their successes.
- be provided information regarding the nature and purpose of higher education.
- be referred to counselors and other resources to explore their interests, skills, abilities and values.
- define and refine educational goals and objectives and understand the consequences of alternative courses of action.
- consider alternative careers through counselors, workshops, seminars and other resources.
- make course, certificate, and/or degree selections.
- understand and utilize placement test results.
- be encouraged to be active participants in their educational planning and college life.
- be informed of support services that are available and how to make an appointment, if appropriate.

Admission/Registration/Enrollment

- be aware of transfer articulation arrangements.
- be informed about research results and general perceptions of student experiences at the institution.
- receive accurate printed materials on academic majors, minors, and other degree and program requirements.
- be encouraged to use the technology which supports the academic advising process.

Registration (AR 2.2.8)

Students must register according to the dates indicated and in the manner described in the college class schedule. To be eligible for registration, students must have completed the appropriate steps listed under the Admissions section. The college may allow early or priority registration. Tuition and fees must be paid by the due date to secure class enrollment. Students may not attend a class for which they are not registered.

Emissions Control Compliance (AR 2.4.6)

Pursuant to A.R.S. §15-1444 C, no vehicle shall be allowed to park in any college parking lot unless it complies with A.R.S. §49-542 (the vehicle emissions inspection program). At the time of course registration, every out-of-county and out-of-state student will be required to sign an affidavit stating that the student's vehicle meets the requirements of A.R.S. §49-542. Vehicles which are not in compliance are subject to being towed at the owner's expense.

Transcripts for Transfer (AR 2.3.10)

The transcript is issued upon written request only. Those students who want to transfer to other institutions of higher education, including other Maricopa Community Colleges, must request their transcripts be sent from the Office of Admissions and Records; however, transcripts may be shared within the Maricopa Community College District without the written request of the student in compliance with the Family Education Rights and Privacy Act of 1974 (FERPA).

Official transcripts will not be issued to students having outstanding debts to any of the Maricopa Community Colleges. The release of transcripts is governed by the guidance of the Family Education Rights and Privacy Act of 1974 (see Records Policy in the Student Rights and Responsibilities section of this publication). There is no charge for unofficial transcripts or for official transcripts sent between Maricopa Community Colleges. See the Tuition and Fees Schedule for charges for other official transcripts.

Tuition and Fees (AR 2.2.9)

Tuition and fees are public monies within the jurisdiction and responsibility of the Maricopa Community Colleges Governing Board under the laws and regulations of the State of Arizona and must be administered by the Governing Board. The Governing Board reserves the right to change tuition and fee charges when necessary without notice.

All students are classified for tuition purposes under one of the following residency classifications:

1. Maricopa County resident
2. Out-of-County resident
3. Out-of-State resident (including F-1 non-immigrant students)
4. Unclassified, Out-of-County, Out-of-State (1-6 credit hours system-wide)

Residency for tuition purposes is determined in accordance with state law (A.R.S. §15-1801 *et. sec.*) and regulations of the Maricopa Community Colleges Governing Board. All of the Maricopa Community Colleges are subject to the above statutes and regulations. Students who have questions about their residency should contact the Office of Admissions and Records for clarification.

Students attending more than one Maricopa Community College will be assessed fees for their enrollment at each of the Maricopa Community Colleges/centers. (Students who are considered to be out-of-state residents for tuition and fees purposes should refer to the Concurrent Enrollment in Arizona Public Institutions of Higher Education policy, page 12, under the Residency section of this publication.)

A. Time of Payment

All tuition, fees, assessments and deposits must be paid at the time of registration or by the specified deadline date and in accordance with the fee schedule approved by the Maricopa Community Colleges Governing Board. Enrollment is not complete until tuition and fees are paid.

B. Tuition and Fees Schedule

(Effective July 1, 2005, for Fall, Spring and Summer Sessions)

The following is a tuition and fees schedule for 2005-2006 and is provided for reference. **These tuition and fees are subject to change.** Consult the college's Office of Admissions and Records for fees in effect at the time you intend to register.

Student Status	Total
1. County Resident - Resident Rate - per credit hour General Tuition: \$58.50 <i>plus</i> Fees: \$1.50	\$60.00
2. County Resident - Audit Rate - per credit hour Audit Fee Surcharge: \$25.00 <i>plus</i> General Tuition: \$58.50 <i>plus</i> Fees: \$1.50	\$85.00
3. Out-of-County Resident - (7+ credit hours system-wide); per credit hour Out-of-County Surcharge: \$198.00 (<i>Applies only to counties with no community college.</i>) <i>plus</i> General Tuition: \$58.50 <i>plus</i> Fees: \$1.50	\$258.00***
4. Out-of-State Resident* - (including F-1 nonimmigrants - 7+ credit hours system-wide); per credit hour Out-of-State Surcharge: \$198.00 <i>plus</i> General Tuition: \$58.50 <i>plus</i> Fees: \$1.50	\$258.00
5. Unclassified Student: Out-of-State & Out-of-County* (less than 7 credit hours system-wide); per credit hour Unclassified Student Surcharge: \$25.00 <i>plus</i> General Tuition: \$58.50 <i>plus</i> Fees: \$1.50	\$85.00

Admission/Registration/Enrollment

6. **Out-of-State students participating in Western Undergraduate Exchange Program***
(any number of credit hours); per credit hour
WUE Out-of-State Surcharge: \$30.00 *plus*
General Tuition: \$58.50 *plus* Fees: \$1.50 \$90.00
7. **Courses offered out of Arizona, including distance learning, to non-resident Out-of-State students****
Total tuition per credit hour: \$147.00
8. **Corporate Tuition Rate: Out-of-State*** (any number of credit hours) for out-of-state employees of companies in training contracts with Maricopa - per credit hour
Out-of-State Surcharge: \$76.00 *plus*
General Tuition: \$58.50 *plus* Fees: \$1.50 \$136.00
9. **Skill Center Hourly Tuition Rates:** \$4.10
10. **Credit by Examination and Credit by Evaluation:**
per credit hour (excludes HCIES courses)
Regular Rate: \$58.50
Contract Testing Rate: \$29.25

Students from the following counties are considered out-of-county and should check with their local County Board of Supervisors about out-of-county tuition and fee payments: Apache, Greenlee and Santa Cruz. Students from any other county in Arizona are considered in-county due to a reciprocal arrangement with that county.

* According to A.R.S. §15-1802F, A person who is a member of an Indian tribe recognized by the U.S. Department of the Interior whose reservation lies in this state and extends into another state and who is a resident of the reservation is entitled to classification as an in-state student. Therefore, unclassified and out-of-state surcharges do not apply to such students.

** According to A.R.S. §15-1429, community college districts are excluded from counting as FTSE those students who reside out of the state but are taking an Arizona community college district distance learning course or a classroom based credit course.

***Rate for 2006-2007 not determined at time of printing. Rates set according to Arizona Revised Statute. Applies only to counties with no community college.

Special Fees

The following fees are in addition to applicable tuition and fees:

Check Returned from Bank	\$15.00
Course Materials Fee	actual cost
Distance Learning Fees	actual cost
Emergency Medical Technology (EMT)	actual cost, not to exceed \$400.00
Excessive Laboratory Breakage	actual cost
Field Studies	actual cost
Field Trips and Out-of-County/Country Tours	actual cost
Fitness Center	\$20.00
GED First Test	\$50.00
GED Test Repeat (per section)	\$10.00
Graduation Fees:	
Application/Recording/Issuance Fee (Degrees/ Certificates - 25 or more credits) nonrefundable	\$5.00
Commencement Fee (One-time fee refundable up to two weeks prior to graduation)	\$25.00
HCIES Skills Demonstration Assessment Fee	actual cost
HESI-PN (Health Education System):	
Practical Nurse for Advanced Placement	actual cost
Library Fines - List price of lost materials plus	\$5.00
NET - Nursing Entrance Test	actual cost

Nursing	
NUR181, 281	\$30.00
NUR169, 189, 269, 289	\$25.00
NUR167, 267	\$25.00
NUR157	\$25.00
NCE214OP Tutored NCLEX Review	\$25.00

Parking Fines*:	
Displaying an altered or substituted permit	\$50.00
Failure to register a vehicle and display a parking permit	\$30.00
Falsifying information on vehicle registration application	\$50.00
Improper display of parking permit (i.e., not affixed to window) ..	\$15.00
Obstructing a properly parked/moving vehicle	\$15.00
Parking in an unauthorized parking area	\$25.00
Parking by a college employee or student in a visitor area	\$15.00
Parking in a fire lane	\$50.00
Parking on or blocking a pedestrian path	\$15.00
Parking outside stall lines	\$15.00
Parking beyond posted time limit	\$15.00
Parking in an undesignated, restricted or unauthorized off-pavement area	\$25.00
Pulling through or backing into an angled parking space	\$15.00
Removing a barricade or failure to obey vehicle control device	\$25.00
Violating disabled parking stall or access	\$50.00

*All parking fines are doubled if not paid within 15 working days. Fees are subject to change upon adoption of the schedule for the new fiscal year. For current fee amounts, please contact College Safety or visit:

http://www.maricopa.edu/gvpolicy/adminregs/students/2_10.htm

PED Special Course Charge actual cost

Private Music Lessons:

Music Majors	
First 1/2 hr. per wk/per semester	\$0.00
Each additional 1/2 hr. per wk/per semester	\$90.00

Non-music Majors	
First 1/2 hr. per wk/per semester	\$280.00
Each additional 1/2 hr. per wk/per semester	\$280.00

Registration Processing Fee (assessed on a per student, per semester, per college basis) Refundable only if the student drops all credit classes at a particular college during the 100% refund period		\$5.00
Transcript Fee		\$5.00

Scottsdale Community College Specific Fees

The College may assess individual course fees, other fees, assessments, fines, or require deposits as authorized by the MCCCD Governing Board. For current fee information, students should consult the appropriate course schedule or contact the Bursar's Office.

Students may incur expenses beyond the established fees in certain courses.

Non-Credit Courses/Seminars/Workshops/Community Services

Fees for these courses are determined by the length and type of each course and will cover total costs.

Admission/Registration/Enrollment

C. Outstanding Debts

Any debt or returned check may revoke a student's current enrollment and the student's right to register in subsequent semesters at all Maricopa Community Colleges. Delinquent debts may require penalties, late charges, collection costs, and/or legal fees to be paid before good standing is restored to the student.

The following procedure will be used for the collection of returned checks and other outstanding debts:

1. The college fiscal agent is responsible for:
 - a. verifying the student's districtwide debt,
 - b. notifying the student of the debt,
 - c. attempting to collect the debt, AND
 - d. notifying credit reporting organizations of the debt.
2. All Maricopa Community College services will be withheld pending payment of debt at college fiscal office with cash, certified check or money order. Student may be withdrawn from classes.
3. If other attempts fail, the Maricopa Community Colleges District Office will either collect or use other means available, including:
 - a. collection agency, requiring payment of collection fees by the student;
 - b. the Tax Refund Setoff Programs as stated in A.R.S. §42-133;
 - c. litigation, requiring payment of court costs and legal fees by the student.

D. Discounted Fees and Waivers

1. Citizens 62 years of age and older shall be issued ID cards that allow them the privilege of attending events at no cost and that allow them to use the library facilities.
2. **Employees, Dependents and Mandated Groups**
The Maricopa Community Colleges waive tuition and student activity fees for employees and their dependents, and for legislative mandated groups. Special fees and fees for Non-Credit/Special Interest Community Services courses are not waived.
3. **Tuition and Registration Fee Waiver for Members of the Pima-Maricopa Indian Community**
Tuition and fee waivers shall be funded through Auxiliary Fund Monies for college credit courses for the enrolled members of the Pima-Maricopa Indian Community who live on the Pima-Maricopa Reservation.

All other guidelines and procedures established for the purpose of administering waivers, affidavits and exemptions are outlined in the Maricopa Community Colleges tuition waiver manual.

Refund Policy (AR 2.2.10)

A. Refund Policy for Credit Classes

Students who officially withdraw from credit classes (in fall, spring or summer) within the withdrawal deadlines listed below will receive a 100% refund for tuition, class and registration processing fees. *Deadlines that fall on a weekend or a college holiday will advance to the next college workday except for classes fewer than ten (10) calendar days in length or as specified by the college. Calendar days include weekdays and weekends.* Refer to individual colleges for withdrawal and appeal processes.

Length of Class	Official Withdrawal Deadlines for 100% Refund*
1-9 Calendar Days	Prior to the class start date
10-19 Calendar Days	1 Calendar day including the class start date
20-29 Calendar Days	2 Calendar days including the class start date
30-39 Calendar Days	3 Calendar days including the class start date
40-49 Calendar Days	4 Calendar days including the class start date
50-59 Calendar Days	5 Calendar days including the class start date
60-69 Calendar Days	6 Calendar days including the class start date
70+ Calendar Days	7 Calendar days including the class start date
*Course fees and registration processing fees will be refunded only if the student qualifies for a 100% refund.	

Debts owed to any MCCCDC college must be satisfied before any refunds are paid to the student.

Refunds for students receiving federal financial assistance are subject to federal guidelines.

B. Refund Policy for Non-Credit Classes

Unless otherwise specified, students must drop non-credit classes prior to the course start date to be eligible for a 100% refund.

C. Canceled Classes

When a class is canceled by the college, a 100% refund will be made.

Admission/Registration/Enrollment

D. Other Refunds

Students withdrawing from a college or from courses for one of the following reasons must submit a written request for a refund to the Office of Admissions and Records or designated college official:

- A student with a serious illness, verifiable by a doctor's written statement that the illness prevents the student from attending all classes for the semester. The doctor's statement must be on file with the college before a refund can be given.
- Serious illness or death of a family member that prevents the student from attending all classes for the semester. Appropriate documentation must be provided before a refund can be given.
- Death of a student. Appropriate documentation must be provided before a refund can be given.

Requests for a total withdrawal from a college or courses for one of the above reasons may result in a partial prorated refund of tuition, provided courses have not been completed.

A student in the Armed Forces or the Arizona National Guard who is called to active duty and assigned to a duty station, verifiable by a copy of the orders, will be allowed to withdraw and receive a 100% refund of tuition, provided courses have not been completed.

Student Financial Assistance (AR 2.2.11 & Appendix E)

The Maricopa Community Colleges provide students financial assistance to enable access to higher education. Student financial assistance shall be awarded on the basis of demonstrated financial need except where funds are specified for recognition of special talents and achievements.

How to Apply for Federal Financial Aid

New students must complete the Free Application for Federal Student Aid (FAFSA) or FAFSA on the web at <http://www.fafsa.ed.gov/>. Caution: Other web sites may charge a fee. Each academic year, continuing students must reapply by completing a FAFSA, Renewal FAFSA, or FAFSA on the web. Scholarships require separate applications. Specific information regarding financial assistance, including application deadlines or priority dates, may be obtained from the college Office of Student Financial Aid.

Types of Aid

Grants, loans, student employment, and scholarship funds may be available from federal, state, and/or private sources.

The Maricopa Community Colleges Foundation offers a variety of scholarship opportunities. Scholarship opportunities are available year round. However, most scholarships are posted mid-January and most deadlines are the last week of March. Options are available at www.maricopa/resdev/scholarships/apply.php or by calling 480-731-8400.

Distribution of Aid

Criteria by which aid is distributed among eligible financial aid applicants are available on request at the college Office of Student Financial Aid.

Rights and Responsibilities

Students should read all information provided in the process of applying for federal financial aid in order to gain a greater knowledge of all the rights as well as responsibilities involved in receiving that assistance.

Satisfactory Academic Progress

Specific requirements for academic progress for financial aid recipients are applied differently than scholastic standards. In addition to scholastic standards, which are explained elsewhere in this catalog, financial aid recipients are also subject to the following Standards of Satisfactory

Academic Progress. Specific information is available at the college Office of Student Financial Aid.

Standards of Satisfactory Academic Progress (SAP) for Financial Aid Eligibility

Federal regulations [CFR 668.32(f) and 668.34] require a student to move toward the completion of a degree or certificate within an eligible program when receiving financial aid. Specific requirements for academic progress for financial aid recipients are applied differently than Scholastic Standards. Federal regulations state that Academic Progress Standards must include a review of all periods of enrollment, regardless of whether or not aid was received. The student must meet the following minimum standards in order to receive financial aid.

I. Evaluation of Financial Aid Eligibility

- A. Standards of Satisfactory Academic Progress (SAP) are applied at least once per year, beginning on or about June 1 to determine the eligibility for the following academic year.
- B. The **evaluation period** will be based on attendance in the immediate prior Spring, Fall, Summer term (example: for 2006-2007 academic year, academic progress will be evaluated on Spring 2006, Fall 2005, and Summer 2005).
- C. Credits evaluated will include credits attempted at the evaluating school and courses funded through consortium agreement.
- D. Students who do not meet the SAP will be notified. The student may follow the appeal process or the reinstatement procedures as outlined in sections V and VI.

II. Eligibility

- A. Students must meet the following criteria:
 1. Students who have attempted at least six (6) credit hours in the last evaluation period must complete with a passing grade 2/3 of all credits attempted within that evaluation period, **OR**
 2. Students who have **NOT** attempted at least six (6) credit hours in the last evaluation period must complete with passing grades 2/3 of **ALL** credits attempted.

AND

- B. All students must meet the following minimum credit hour/cumulative GPA requirement:

Credits Attempted*	Min. GPA
12-15	1.60
16-30	1.75
31-45	1.90
46 +	2.00

*For which grade points are computed.

Note: Grades of **F, I, N, W, X, Y, Z**, and courses not yet graded are considered attempted but not meeting progress standards for the purposes of financial aid.

III. Maximum Time Frame Eligibility

- A. Students who have attempted more than 150% of the credits required for their program of study are not considered to be making Satisfactory Academic Progress and, therefore, are ineligible for financial aid funds.
- B. All evaluated transfer credits will be included when determining Maximum Time Frame Eligibility.
- C. A student with a Bachelor's degree or higher will be considered to have exhausted Maximum Time Frame Eligibility. An exception to this rule occurs if the student is enrolled in a state-approved teacher certification program.
- D. A student may appeal as outlined in section V.
- E. Reinstatement procedures as outlined in section VI are not applicable to Maximum Time Frame Eligibility.

Admission/Registration/Enrollment

IV. Repeated, Audited, Consortium, Remedial Courses, Summer Sessions

- Financial aid may be used to cover the cost of repeated courses.
- Audited courses, non-credit courses, credit by examination, and any credit for prior learning option (as outlined in the catalog) are excluded when determining eligibility for financial aid.
- Courses funded through a consortium agreement are included in determining academic progress.
- All attempted remedial credits will be included when evaluating SAP. (A maximum of 30 remedial credit hours, excluding ESL courses, may be funded.)
- Enrollment in any or all summer sessions within the same calendar year will be considered one term.

V. Appeal Process

A student who has lost financial aid eligibility due to extenuating circumstances may appeal.

- Extenuating circumstances that may be considered include: personal illness or accident, serious illness or death within immediate family, or other circumstances beyond the reasonable control of the student.
- All appeals must be in writing to the Financial Aid Office where the student is applying for aid and include appropriate documentation.
- Examples of documentation could include an obituary notice, divorce decree, or a letter from a physician, attorney, social services agency, parole officer, etc.
- The condition or situation must be resolved which will allow the student the ability to complete coursework successfully or an appeal will not be granted.
- The outcome of an appeal may include approval, a probationary period, or denial.
- A student will be notified in writing of the results of the appeal, and of any restrictions or conditions pertaining to their appeal.

VI. Reinstatement of Financial Aid Eligibility

- A student who has lost financial aid eligibility may be reinstated after the student has taken (without federal funds) at least six (6) credit hours in a semester, passed all attempted credit hours, and meets minimum cumulative GPA requirements.
- If the student attempts more than six hours, the student will be evaluated on all attempted credit hours within that term.
- Classes taken at other colleges will not be taken into consideration for reinstatement purposes.
- It is the student's responsibility to notify the Office of Student Financial Aid when this condition has been met.

For more information, please contact the Office of Student Financial Aid.

Refunds and Repayments

In accordance with federal regulations (CFR 668.22), a student may be required to repay federal financial aid funds if they completely withdraw, are withdrawn, or fail to earn a passing grade from all classes during a semester. Further information is available at the college Office of Student Financial Aid. This could affect a student's ability to receive financial aid in the future at any school. For a student receiving financial aid, also see Appendix G for withdrawal procedures, page 31.

Award Amount and Level of Enrollment

Award amount is determined, in part, on the level of enrollment. Federal student aid recipients are advised to register at the same time for all classes they intend to take during a semester to maximize award. Some federal aid may not be awarded for classes added at a later date. Contact the college Office of Student Financial Aid for more information.

Veterans Services (AR 2.9)

The Maricopa Community Colleges' veterans services offices act as liaisons with the Department of Veterans Affairs. Each program must be approved by the State of Arizona Department of Veterans' Services. Students may be eligible to receive educational benefits if they are registered in courses that apply to the student's approved program. Application forms, counseling, advisement and tutoring are available for students who are eligible for veteran's educational benefits. Students applying for veteran's educational benefits should allow eight to ten weeks before receiving benefits. The amount of benefits awarded is determined by the Department of Veterans Affairs, and is based on the number of credit hours or clock hours for which a student is enrolled and the length of enrollment period for each course.

Veteran's benefits available:

- Chapter 30 Montgomery GI Bill
- Chapter 31 Vocational Rehabilitation (separately served through the local VA office)
- Chapter 32 VEAP Program
- Chapter 35 Survivors and dependents of deceased/100% disabled veterans
- Chapter 1606 Montgomery GI Bill, Selected Reserve

It is the student's responsibility to notify the office that serves veterans at their campus regarding any change in enrollment, address, program of study, enrollment at another institution, or any other change that may impact their veteran's educational benefits.

Those students receiving benefits must follow the VA academic progress policy to continue to receive benefits.

Academic Progress Policy for Students Receiving Veteran's Educational Benefits

Credit Hours for Which Grade Points are Computed at Resident Maricopa Community College (A,B,C,D,F & Y)	Minimum Grade Point Average Required
12 - 15	1.60
16 - 30	1.75
31 - 45	1.90
46 +	2.00

Department of Veterans Affairs regulations require that all persons using any type of veteran educational assistance program be making satisfactory academic progress toward achievement of their educational objective (program of study). A student who does not meet the minimum standards (see above) will be placed on probation for a maximum of two (2) consecutive semesters. At this point, if satisfactory academic progress has not been demonstrated, veteran educational benefits will be terminated. **Benefits may be resumed when the student raises the cumulative grade point average to the required minimum standards or demonstrates the ability to meet these standards through the approval of a written appeal. For appeal procedures, contact the office that serves veterans at your campus.**

For additional details and information regarding veteran's educational benefits, contact the office that serves veterans at your campus.

Academic Load (AR 2.3.1)

The following guidelines are for institutional purposes. Rules regarding academic load for financial aid eligibility, veteran benefits and athletic eligibility may be defined differently.

Students carrying at least twelve (12) credit hours will be considered full-time students for the fall and spring semesters. Three-quarter-time is 9 - 11.9 credit hours. Half-time is 6 - 8.9 credit hours. Fewer than six (6) credit hours is considered less than half-time. Academic load for summer and special terms may be defined differently. Contact the Office of Admissions and Records for clarification.

Courses vary in length, and begin and end throughout the year. A credit hour indicates the value of an academic credit. Standards for the awarding of credit hours may be time based or competency based. To obtain credit, a student must be properly registered and must pay fees for the course. The fall and spring semesters are typically sixteen (16) weeks in length. Summer sessions are typically five (5) or eight (8) weeks in length.

Students desiring to take more than eighteen (18) credit hours must obtain approval from the designated college official. Ordinarily, only students with a grade point average of 3.0 or higher for the preceding semester or first semester students who were in the upper quarter of their high school graduating class are permitted to carry more than eighteen (18) credit hours.

Students participating in extra-curricular or co-curricular activities or receiving financial assistance may be required to maintain a specified minimum academic load.

Students who are working, have considerable extra-curricular activities or co-curricular activities, or have been reinstated from academic suspension/probation should plan their academic load accordingly.

Schedule Changes

Students may change their schedule by following the designated procedures at their college of enrollment. It is the student's responsibility to notify the college if he/she will no longer be attending class (see withdrawal policy, page 31).

Attendance (AR 2.3.2)

Only persons who are registered for a class at any of the Maricopa Community Colleges may attend that class.

Attendance requirements are determined by the course instructor. Students who do not meet the attendance requirement as determined by the course instructor may be withdrawn.

Students who fail to attend the first scheduled class meeting, or to contact the instructor regarding absence before the first scheduled class meeting may, at the option of the instructor, be withdrawn.

At the beginning of each course, each faculty member will provide students with written attendance requirements. It is the student's responsibility to consult with the instructor regarding official or unofficial absences. Absences begin to accumulate with the first scheduled class meeting.

Students bear the responsibility of notifying the Office of Admissions and Records when they discontinue studies in a course or at the college. Please refer to the Withdrawal Procedures, page 31.

A. Official Absences

Official absences are those which occur when students are involved in an official activity of the college (e.g., field trips, tournaments, athletic events) and present an official absence excuse form. Absences for such events shall not count against the number of absences allowed by an instructor or department. Students who must miss a class for an official reason must obtain an official absence verification card from the appropriate vice president or designee and present it to the appropriate instructor(s) before the absence. Prior arrangements must be made with each instructor for make-up work. If prior arrangements have been made, the student will not be penalized.

Other official absences include jury duty and subpoenas. Appropriate documentation will be required. Prior arrangements must be made with each instructor for make-up work. If prior arrangements have been made, the student will not be penalized.

In the event of the death of an immediate family member, absences for periods of up to one week will not be counted against the number of absences allowed by an instructor or department. Students should contact instructor(s) as soon as possible to arrange for make-up work. Appropriate documentation will be required (for example, a copy of the obituary or funeral program). In specialized programs that require clinical rotations, this regulation may not apply.

B. Religious Holidays

Students shall have the right to observe major religious holidays without penalty or reprisal by any administrator, faculty member or employee of the Maricopa Community Colleges. Absences for such holidays shall not count against the number of absences allowed by an instructor or department. At least one week before the holiday, students shall submit to their instructor(s) a written statement which includes both the date of the holiday and the reason why class attendance is impossible. Prior arrangements must be made with each instructor for make-up work. If prior arrangements have been made, the student will not be penalized.

Grading (AR 2.3.3)

A. Policy

It is the policy of the Maricopa Community Colleges that a grade will be assigned at the conclusion of the course. Official grades are available on designated college web sites.

Grade Key

A - Excellent	4 grade points per credit hour
B - Above Average	3 grade points per credit hour
C - Average	2 grade points per credit hour
D - Passing	1 grade point per credit hour
F - Failure	0 grade point per credit hour
I - Incomplete	Not computed in grade point average
IP - Course in Progress	Not computed in grade point average
N - Audit	Not computed in grade point average
P* - Credit	Not computed in grade point average
W - Withdrawn, passing	Not computed in grade point average
Y - Withdrawn, failing	0 grade point per credit hour
Z - No Credit	Not computed in grade point average

*A P is judged to be equivalent to a grade of C or higher.

Continued next page...

Scholastic Standards

B. Incomplete Grade

Students who are doing acceptable work may request an incomplete grade (I) if they are unable to complete the course requirements by the end of the term because of illness or other extenuating circumstances. If the request is approved by the instructor, he or she shall define, in a written contract, how the course will be completed. The contract will be filed with the Office of Admissions and Records.

Students must complete the requirements within the time period agreed to—maximum time allowed is seven (7) months from the last date of class in which the grade of incomplete was assigned. Students who do not complete the requirements within seven (7) months will have their grade recorded in accordance with the written contract. Students should NOT reregister for the course to complete the contract.

C. Repeating a Course/Improving a Grade

To improve a previously earned grade, students may repeat the course up to three times after the initial attempt to improve a grade. (A W or Y is not considered an attempt.) Students planning to enroll in a course for the third time should seek advisement prior to enrolling. All enrollments in a course will appear on the transcript and will be included in calculating the grade point average. The student may request in writing that the course(s) with the lower grade(s) be excluded during the grade point average calculation. The written request must be submitted to the Office of Admissions and Records at the Maricopa Community College where the course with the lower grade was taken. Check individual courses and programs for exceptions.

D. Credit/No Credit Courses (P/Z)

Some courses may be taken under a credit/no credit grading system. These courses carry grades of P (credit, equivalent to a grade of C or higher) or Z (no credit) and are not computed in the student's grade point average. Credits earned with a grade of P may be counted toward graduation.

The prescribed time limits are for full-semester classes. Time limits for classes which meet fewer than sixteen (16) weeks are adjusted accordingly. (See "Important Deadlines for Students," page 29.)

In courses with credit/no credit (P/Z) grading, the student may request standard grading (A, B, C, D, F), within fourteen (14) days including the date of the first class meeting. The instructor must immediately notify the Office of Admissions and Records.

In courses with standard grading (A, B, C, D, F), the instructor determines if the credit/no credit option is available. If the option is available, the student must obtain the permission of the instructor. The instructor must notify the Office of Admissions and Records within fourteen (14) days including the day of the first class meeting.

It is the student's responsibility to verify the transferability of credit/no credit courses. Some universities place a limitation on the number of credit/no credit courses that can be transferred.

Advisory note: Some institutions outside the Maricopa Community Colleges may translate the Z grade as failing.

E. Audit Courses

Auditors are those who enroll in a course for the sole purpose of obtaining information; they receive no credit, grades, homework, or tests. If an auditor wishes to earn credit, he or she must change from audit status to credit status within the first week. If a student wishes to audit a course for which he or she is enrolled for credit, the change must be made within the first five (5) weeks of a semester. Auditors are subject to the same attendance policies as other students and must meet the same prerequisite requirements or obtain approval of the instructor. See the fee schedule for charges. Financial aid is not available for audited courses.

The prescribed time limits are for full-semester classes. Time limits for classes which meet fewer than sixteen (16) weeks are adjusted accordingly. (See "Important Deadlines for Students," page 29.)

Academic Probation (Progress) (AR 2.3.4)

A. Probation

A student will be placed on academic probation under the following conditions:

1. If, after completion of twelve (12) or more credit hours, the student's cumulative grade point average is less than:

Credit Hours for Which Grade Points are Computed at Resident Maricopa Community College (A,B,C,D,F and Y)	Minimum Grade Point Average Required
12 - 15	1.60
16 - 30	1.75
31 - 45	1.90
46 +	2.00

(Note: Students should also be aware that graduation requires a cumulative minimum grade point average of 2.00.)

2. If, in transferring from any accredited institution of higher education, the student's cumulative grade point average from other colleges and universities does not meet the requirements listed above.

Students on academic probation may take no more than twelve (12) credit hours per semester unless approved by the Admissions and Standards Committee.

B. Continued Probation

A student on academic probation who fails to raise the cumulative grade point average to the required minimum standards (see above) will be placed on continued probation and may be limited to taking six (6) credit hours.

Regulations regarding continued probation do not apply to the summer session. Credit hours earned in summer sessions will be included in the cumulative grade point average.

C. Admission of Suspended Students

Transfer students who do not meet the minimum grade point average listed under Scholastic Standards may be admitted on academic probation.

Scholastic Standards

IMPORTANT DEADLINES FOR STUDENTS

Deadlines are based on calendar days and begin with the first day of class.
Deadlines that fall on a weekend or holiday advance to the next college work day.

Class Length	Deadline for Students to Withdraw with Guaranteed Grade of W	Deadline for Students to Withdraw From a Course (Instructor Signature Required)	Deadline for Students to Request Complete Withdrawal	Deadline to Change Type of Grading (A-F to P/Z, or P/Z to A/F)	Deadline to Change from Audit Grade to Credit Grade	Deadline to Change from Credit Grade to Audit Grade
One Week or less (1 to 7 days)	1 st Day of Class	1 st Day of Class or Prior to the Last Day of Class	1 st Day of Class or Prior to the Last Day of Class	1 st Day of Class	1 st Day of Class	1 st Day of Class
Two Weeks (8 to 14 days)	3 rd Calendar Day	6 th Calendar Day	6 th Calendar Day	1 st Day of Class	1 st Day of Class	3 rd Calendar Day
Three Weeks (15 to 21 Days)	6 th Calendar Day	12 th Calendar Day	12 th Calendar Day	2 nd Calendar Day	1 st Day of Class	5 th Calendar Day
Four Weeks (22 to 28 days)	9 th Calendar Day	17 th Calendar Day	17 th Calendar Day	3 rd Calendar Day	2 nd Calendar Day	7 th Calendar Day
Five Weeks (29 to 35 days)	12 th Calendar Day	23 rd Calendar Day	23 rd Calendar Day	4 th Calendar Day	2 nd Calendar Day	9 th Calendar Day
Six Weeks (36 to 42 days)	14 th Calendar Day	29 th Calendar Day	29 th Calendar Day	5 th Calendar Day	3 rd Calendar Day	11 th Calendar Day
Seven Weeks (43 to 49 days)	17 th Calendar Day	35 th Calendar Day	35 th Calendar Day	5 th Calendar Day	3 rd Calendar Day	12 th Calendar Day
Eight Weeks (50 to 56 days)	20 th Calendar Day	41 st Calendar Day	41 st Calendar Day	6 th Calendar Day	3 rd Calendar Day	15 th Calendar Day
Nine Weeks (57 to 63 days)	23 rd Calendar Day	46 th Calendar Day	46 th Calendar Day	7 th Calendar Day	4 th Calendar Day	17 th Calendar Day
Ten Weeks (64 to 70 days)	26 th Calendar Day	52 nd Calendar Day	52 nd Calendar Day	8 th Calendar Day	4 th Calendar Day	19 th Calendar Day
Eleven Weeks (71 to 77 days)	29 th Calendar Day	58 th Calendar Day	58 th Calendar Day	9 th Calendar Day	5 th Calendar Day	21 st Calendar Day
Twelve Weeks (78 to 84 days)	32 nd Calendar Day	63 rd Calendar Day	63 rd Calendar Day	10 th Calendar Day	5 th Calendar Day	23 rd Calendar Day
Thirteen Weeks (85 to 91 days)	35 th Calendar Day	70 th Calendar Day	70 th Calendar Day	10 th Calendar Day	5 th Calendar Day	25 th Calendar Day
Fourteen Weeks (92 to 98 days)	38 th Calendar Day	76 th Calendar Day	76 th Calendar Day	11 th Calendar Day	6 th Calendar Day	27 th Calendar Day
Fifteen Weeks (99 to 105 days)	41 st Calendar Day	82 nd Calendar Day	82 nd Calendar Day	12 th Calendar Day	6 th Calendar Day	28 th Calendar Day
Sixteen Weeks or more (106 or more days)	End of the seventh week	Two weeks before the last class period	Two weeks before the last class period	Within 14 days including the first class period	Within first week of class	Within first five weeks

Instructional Grievance Process (AR 2.3.5 & Appendix F)

A student who feels that he or she has been treated unfairly or unjustly by a faculty member with regard to an academic process such as grading, testing, or assignments has the right to appeal according to the approved procedures. The appeal process for grades expires one (1) year from the date the grade was issued.

Steps for students to take:

1. Discuss the issue with the faculty member involved. This conference should be requested by the student within fifteen (15) working days from the time the student knew or reasonably should have known about the unfair or unjust treatment.
2. If, within ten (10) working days of the request for the conference with the faculty member, the problem is not resolved or the faculty member has been unable to meet with the student, the student may continue the process by filing a written complaint with the department/division chairperson and appropriate administrative officer at the college/center. This written complaint must be filed within ten (10) working days following the previous deadline. The written complaint will be given to the faculty member five (5) days before any official meetings are convened.
3. Upon receipt of a written complaint, the department/division chair or appropriate college administrative officer will work with the parties in an attempt to resolve the conflict. The faculty member may ask that the college faculty senate president be in attendance. Every attempt will be made to maintain confidentiality during this process. A faculty member will not be required to respond to a complaint which is not in writing and which, when appropriate, did not have specific documentation including dates, times, materials, etc. The written complaint will be made to the faculty member.
4. If the grievance is not resolved at this level within ten (10) working days, the student should forward to the vice president of academic

affairs or designee a copy of the original written complaint with an explanation regarding action taken at each prior level. The vice president of academic affairs or designee will meet with the student, faculty member, the college faculty senate president if requested by the faculty member, and department/division chairperson and attempt to resolve the issues. This level will be the final step in any grievance process regarding grades.

5. If the grievance, other than those concerning grades, is not resolved by the vice president of academic affairs or designee, it may be forwarded in writing by the student to the college president for final resolution. The college president or designee will expedite a timely examination of the issues and will issue a final written determination in the grievance process.

Non-Instructional (Outside the Classroom) Complaint Resolution Process

A student who feels that he or she has been treated unfairly or unjustly by any employee with regard to a non-instructional process such as student or administrative services has the right to file a formal and written complaint according to the approved procedures.

Steps for students to take:

1. Discuss the issue with the employee involved. The student should request this conference within fifteen (15) working days from the time the student knew or reasonably should have known about the unfair or unjust treatment.
2. If, within ten (10) working days of the request for the conference with the employee, the problem is not resolved or the employee has been unable to meet with the student, the student may continue the process by filing a written complaint with the appropriate supervisor of the employee where authority exists to take corrective action. This written complaint must be filed within ten (10) working days following the previous deadline. The written complaint will be given to the employee five (5) working days before any official meetings are convened.

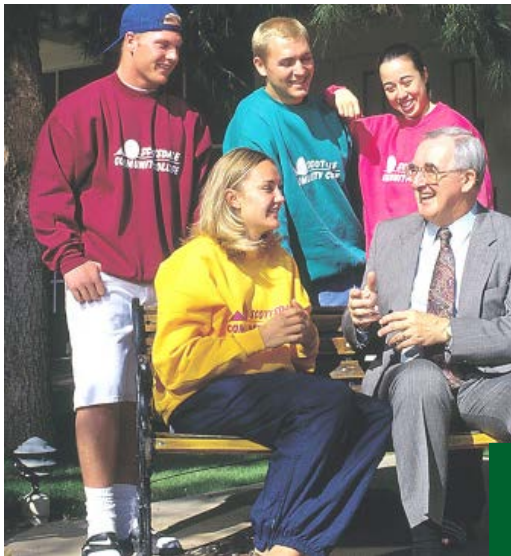

**The 'Prez' and
SCC Students**

Scholastic Standards

3. Upon receipt of a written complaint, the appropriate supervisor will work with the parties in an attempt to resolve the conflict. Every attempt will be made to maintain confidentiality during this process. An employee will not be required to respond to a complaint which is not in writing and which, when appropriate, does not have specific documentation including dates, times, actions, supporting documents, etc. The written complaint will be made available to the employee.
4. If the complaint is not resolved at this level within ten (10) working days, the student should forward to the appropriate college/center vice president or designee a copy of the original written complaint with an explanation regarding action taken at each prior level. The vice president or designee will meet with the student, the employee, and the relevant supervisor and attempt to resolve the issues.
5. If the vice president or designee does not resolve the complaint, the student may forward it in writing to the college president for final resolution. The college president or designee will issue a final written determination in the complaint process.

Withdrawal (AR 2.3.6)

To withdraw from a course or courses from the college, students must follow approved procedures. The Office of Admissions and Records provides information about the withdrawal process.

The official date of withdrawal is the last date of attendance as determined by the student's withdrawal or as reported by the instructor. The official date of withdrawal determines refunds.

Never attending is not a guarantee for a refund or an excuse of the debt incurred through registration. Please see the refund policy, page 24.

The prescribed time limits are for full-semester classes. Time limits for classes which meet fewer than sixteen (16) weeks are adjusted accordingly. (See Important Deadlines for Students, page 29.) Failure to file an official withdrawal form may result in failing grades and responsibility for course tuition and fees.

Withdrawal Procedures (Appendix G)

A. Withdrawal from Specific Courses

Students may be officially withdrawn from specific courses in the following ways:

1. Through the 7th week, a student may initiate an official withdrawal from any course by submitting a course withdrawal form with the required signatures to the Office of Admissions and Records in accordance with the published deadlines. A grade of **W** (withdrawn, passing—not computed in the grade point average) or **Y** (withdrawn, failing—computed in the GPA as a failing grade) will be assigned.

2. After the 7th week, a student may initiate a withdrawal. The faculty member will sign the form and assign a grade of **W** or **Y**. The form is then to be returned to the Office of Admissions and Records. (See the college academic calendar for student deadline date.)
3. A faculty member has the option of withdrawing a student who has accumulated unofficial absences in excess of the number of times a class meets per week. Students withdrawn for excessive absences may be reinstated only with the approval of the faculty member. A grade of **W** will be assigned through the 7th week. After the 7th week, a grade of **W** or **Y** will be assigned. Faculty members electing to withdraw students must file the withdrawal form, including the last date of attendance, with the Office of Admissions and Records.

Failure to file an official withdrawal form may result in failing grades.

B. Complete Withdrawal from College

Students electing to withdraw from the college must contact the Office of Admissions and Records no later than two (2) weeks before the end of the last class meeting and may be required to file a written request.

A grade of **W** will be assigned in all courses for students who withdraw by the end of the 7th week of classes. Withdrawals completed after this time will result in a grade of **W** (withdrawn, passing—not computed in the grade point average) or **Y** (withdrawn, failing—computed in the GPA as a failing grade).

C. Withdrawal of Financial Aid Students

In accordance with federal regulations (CFR 668.22), a student may be required to repay federal financial aid funds if they completely withdraw or are withdrawn or fail to earn a passing grade from all classes during a semester. Further information is available at the college Office of Student Financial Aid. This could affect a student's ability to receive Financial Aid in the future at any school.

Scholastic Standards

Academic Renewal (AR 2.3.7)

Students who are returning after a separation of five (5) years or more from the Maricopa Community College District may petition for academic renewal. The request must be in writing and submitted to the Office of Admissions and Records at the college where the grades were earned.

Academic renewal at one of the Maricopa Community Colleges does not guarantee that colleges outside the Maricopa Colleges will accept this action. Acceptance of academic renewal is at the discretion of the receiving institution.

- A. Prior to petitioning for academic renewal, the student must demonstrate renewed academic performance by earning a minimum of twelve (12) credit hours and a cumulative grade point average (GPA) of 2.5 or higher within Maricopa Colleges after reenrollment.
- B. Upon approval, all courses taken prior to reenrollment with a grade of **A**, **B**, **C**, **D**, **F**, and **Y** will be annotated as academic renewal on the student's permanent record. All course work affected by academic renewal will not be computed in the grade point average. Courses with grades **A**, **B** or **C** will have the associated credit hours counted in the total credit hours earned. Such credit will not be computed in the grade point average.
- C. All course work will remain on the student's permanent academic record, ensuring a true and accurate academic history.
- D. The academic renewal policy may be used only once at each college and cannot be revoked once approved.
- E. Students who have been granted Academic Renewal must also meet the Financial Aid Standards of Academic Progress if they wish to receive financial aid.



Honors Program (AR 2.3.8)

Each of the Maricopa Community Colleges has an honors program. Interested students should contact the college honors coordinator for information about the program and available scholarships, including the Chancellor's, Foundation's, and President's Scholarships.

President's Honor List

The President's Honor List for each college consists of all students who complete twelve (12) or more credit hours in residence in courses numbered 100 or higher in a given semester with a college semester grade point average (GPA) of 3.75 or higher.

**SCC Campus -
Camelback View**

MCCCD ARIZONA GENERAL EDUCATION CURRICULUM (AGEC)

AGEC-A, AGECE-B, AGECE-S

The Maricopa County Community College District Arizona General Education Curriculum (MCCCD AGECE) is a 35-semester-credit general education certificate that fulfills lower-division general education requirements for students planning to transfer to any Arizona public community college or university. The MCCCD AGECE transfers as a block without loss of credit.

All credits used to satisfy the MCCCD AGECE will apply to graduation requirements of the university major for which the AGECE was designed, regardless of whether the credit was awarded for completion of course work or for prior learning. For additional information on credit awarded for prior learning assessment, see the policy on Credit for Prior Learning in this catalog.

For students planning to pursue an associate degree or transfer to an Arizona public community college or university, the AGECE-A is a component of the MCCCD Associate in Arts, the AGECE-B is a component of the MCCCD Associate in Business, and the AGECE-S is a component of the MCCCD Associate in Science.

Purpose of the AGECEs

There are three types of MCCCD AGECEs. They are the AGECE-A, the AGECE-B, and the AGECE-S. Designed to articulate with different academic majors, their requirements vary accordingly. Additional information on academic majors at the Arizona public universities can be accessed via the following website:

<http://az.transfer.org/cas/atass/index.html>

Select *Student Information* followed by:
Degrees and Pathways

Scroll down to the bottom of the page and select the letter of the major you are interested in.

1. The AGECE-A is designed to satisfy requirements in many liberal arts majors as well as other majors that articulate with the Associate in Arts (e.g., social sciences, fine arts, humanities). AGECE-A requires a minimum of college mathematics or college algebra to satisfy the Mathematics [MA] requirement. AGECE-A Mathematics requirement is less stringent than the AGECE-B and AGECE-S. AGECE-A and AGECE-B Natural Sciences requirements are less stringent than AGECE-S.
2. The AGECE-B is designed to satisfy requirements in business majors that articulate with the Associate in Business. AGECE-B requires a minimum of brief calculus to satisfy the Mathematics [MA] requirement.
3. The AGECE-S is designed to satisfy requirements in majors with more prescriptive mathematics and mathematics-based science requirements. AGECE-S articulates with the Associate in Science. AGECE-S requires a minimum of the first course in a calculus sequence to satisfy the Mathematics [MA] requirement, and a minimum of eight (8) credits of either university chemistry, university physics or general biology to satisfy the Natural Sciences [SQ/SG] requirement.

Academic Policies that Govern the AGECE-A, AGECE-B, and AGECE-S:

- requires 35 semester credits in courses numbered 100 and above to be completed with a grade of C or better. Credit units transferred from outside of the district need to be at a grade of C or better. A grade of C equals 2.0 GPA on a 4.0 grading scale or equivalent.
- uses the following policies to help students complete the required Core and Awareness Areas without exceeding the 35 semester credits:
 1. Courses can satisfy a Core Area and one or two Awareness Areas simultaneously.
 2. A course cannot be used to satisfy more than one Core Area requirement.

- follows the general education policy below:

General Education Designations (example: [FYC], [SB], [HU], etc.) Effective Fall 2000, the course evaluation and/or general education designation as listed in the Arizona CEG (Course Equivalency Guide) within the Arizona Course Applicability System (AZCAS) is valid for the **term** in which the student is awarded credit on the transcript. A course evaluation and/or general education designation may be subject to change. Given that curriculum is dynamic at both MCCCD and the institutions to which MCCCD students transfer, students have the option to petition for course evaluations and/or general education designations.

<http://az.transfer.org/cas/atass/index.html>

Select *Student Information* followed by:

Course Applicability System (CAS)

Course Equivalency Guide (CEG)

Maricopa Community College District

- require courses that transfer as equivalent courses, departmental elective credit (XXXXDEC), or general elective credit (Elective) at all Arizona public universities according to the Arizona CEG. The course evaluation and/or general education designation as listed in AZCAS is valid for the term in which the student is awarded credit on the transcript;
- require that a minimum of 12 semester credits of course work be taken at any of the MCCCD colleges;
- include both courses and their modular equivalents, either the course or the modular equivalents will satisfy the AGECE;
- accept one of the courses that is cross-referenced with other courses;
- provide for exemption from Arizona university admission requirements for: Students who complete the AGECE-A, AGECE-B or AGECE-S with a minimum 2.0 GPA on a 4.0=A scale, or students who complete an associate or higher degree from a regionally accredited post-secondary institution with a minimum 2.0 GPA on a 4.0=A scale for Arizona residents and a minimum 2.5 GPA on a 4.0=A scale for nonresidents.

AGECE Requirements

The 35 semester credits required for each of the three AGECEs follow. See the list entitled [MCCCD Courses That Can Be Used to Satisfy MCCCD AGECE-A, AGECE-B and/or AGECE-S](#), page 36, for specific course information. The most up-to-date information can be accessed at the following web address:

<http://www.maricopa.edu/academic/curric/>

Select tab labeled *Curriculum Procedures Handbook - Programs*

Select *Academic Programs*

Select *Matrix of MCCCD Courses* (AGECE Course Matrix)

The list identifies the courses in alpha-order by prefix as well as the different Core Areas and Awareness Areas where the course will apply. When selecting Mathematical Studies and Natural Sciences options, select from the appropriate AGECE-A, B or S list.

A. CORE AREAS (35 credits required):

1. First-Year Composition (FYC) 6
2. Literacy and Critical Inquiry [L] 3
3. Mathematical Studies [MA/CS] 6

To complete the Mathematical Studies requirement select one course to satisfy the Mathematics [MA], and a second course from Computer/Statistics/Quantitative Applications [CS]. NOTE: The Mathematics [MA] requirement differs for AGECE-A, AGECE-B and AGECE-S.

AGECE-A requires:

- a. Mathematics [MA] A (3 credits) AND

NOTE: requires a course in college mathematics (MAT142) or college algebra (MAT150, MAT151, MAT152) or precalculus

Continued next page...

Arizona General Education Curriculum

(MAT187) or any other mathematics course designated with the MA general education value and for which college algebra is a prerequisite.

b. Computer/Statistics/Quantitative Applications [CS] (3 credits)

AGEC-B requires:

a. Mathematics [MA] B (3 credits) AND

NOTE: requires a course in brief calculus (MAT212) or a higher level mathematics course (MAT216, MAT220, or MAT221 or any course for which these courses are prerequisites).

b. Computer/Statistics/Quantitative Applications [CS] (3 credits)

AGEC-S requires:

a. Mathematics [MA] S (3 credits) AND

NOTE: requires a calculus course (MAT220 or MAT221) or any course for which MAT220 or MAT221 are prerequisites.

b. Computer/Statistics/Quantitative Applications [CS] (3 credits)

4. Humanities and Fine Arts [HU] 6

Students are encouraged to choose courses from more than one discipline for a total of six (6) semester credits.

5. Social and Behavioral Sciences [SB] 6

Students are encouraged to choose courses from more than one discipline for a total of six (6) semester credits.

6. Natural Sciences [SQ/SG] 8

To complete the Natural Sciences requirement:

AGEC-A and AGEC-B require four (4) semester credits of [SQ] and four (4) semester credits of [SG] for a total of eight (8) semester credits, OR eight (8) semester credits of [SQ]. Students cannot take eight (8) semester credits of [SG] to meet the Natural Sciences requirement.

The Natural Sciences requirement [SQ/SG] differs for AGEC-S. AGEC-S requires eight (8) semester credits of either university chemistry OR eight (8) semester credits of university physics OR eight (8) semester credits of general biology appropriate to the major.

The lecture course(s) selected for Natural Sciences must include or be accompanied by the corresponding laboratory course. The lecture and corresponding laboratory course(s) may carry separate credit. Students should consult with an advisor for appropriate course selection. Students should also access the AZ Course Equivalency Guide (CEG) within the AZ Course Applicability System (AZCAS) for information on transfer equivalencies.

B. AWARENESS AREAS:

Students must satisfy two Awareness Areas: Cultural Diversity in United States [C] AND either Global Awareness [G] OR Historical Awareness [H]. However, it is not necessary for students to exceed thirty-five (35) semester credits to complete any of the three MCCC CD AGECS because courses can satisfy a Core Area and one or two Awareness Areas simultaneously. Therefore, no additional semester credits are required to satisfy the two Awareness Areas.

1. Cultural Diversity in the United States [C] AND

2. Global Awareness [G] OR

3. Historical Awareness [H]

AGEC Area Requirements Descriptions/Definitions

CORE AREAS

First-Year Composition (FYC) 6 credits

A total of six (6) semester credits must be completed with a grade of C or better in the First-Year Composition Core Area. Courses must emphasize skills necessary for college-level learning and writing skills.

Literacy and Critical Inquiry [L] 3 credits

A total of three (3) semester credits must be completed with a grade of C or better in the Literacy and Critical Inquiry Core Area. In the [L]

course, typically at the sophomore level, students gather, interpret, and evaluate evidence and express their findings in writing or speech. This course includes a series of graded written or spoken formal assignments.

Literacy is defined broadly as communicative competence in written and oral discourse; critical inquiry is defined as the gathering, interpreting, and evaluating of evidence. Building on the proficiency attained in traditional First-Year Composition courses, the Literacy and Critical Inquiry requirement helps students sustain and extend their ability to reason critically and communicate clearly through language.

Mathematical Studies [MA/CS] 6 credits

A total of six (6) semester credits must be completed with a grade of C or better in the Mathematical Studies Core Area. One course must be selected from Mathematics [MA]. A second course must be selected from Computer/Statistics/Quantitative Applications [CS].

The Mathematical Studies requirement is intended to ensure that students have skill in basic mathematics, can use mathematical analysis in their chosen fields, and can understand how computers make mathematical analysis more powerful and efficient.

First, the acquisition of essential skill in basic mathematics requires the student to complete a course in college algebra or to demonstrate a higher level of skill by completing a course for which college algebra is a prerequisite.

Second, the real-world application of mathematical reasoning requires the student to take a course in statistics or the use of quantitative analysis to solve problems of substance.

Third, the use of the computer to assist in serious analytical work is required. Computers are widely used to study the implications of social decisions or to model physical systems.

Mathematics [MA] AGEC-A

The AGEC-A Mathematics Core Area requires a course in college mathematics, college algebra, precalculus or any other mathematics course for which college algebra is a prerequisite.

Mathematics [MA] AGEC-B

The AGEC-B Mathematics Core Area requires a course in Brief Calculus or a higher level mathematics course.

Mathematics [MA] AGEC-S

The AGEC-S Mathematics Core Area requires the first course in the calculus sequence or any mathematics course for which that course is a prerequisite.

Computer/Statistics/Quantitative Applications [CS]

AGEC-A, B and S [CS] option requires courses that emphasize the use of statistics or other mathematical methods in the interpretation of data and in describing and understanding quantitative relationships, and courses that involve the use of computer programming languages or software in the development of skills in analytical thinking.

Humanities and Fine Arts [HU] 6 credits

A total of six (6) semester credits must be completed with a grade of C or better in the Humanities and Fine Arts Core Area. Students are encouraged to choose coursework from more than one discipline for a total of six (6) semester credits.

The Humanities and Fine Arts Core Area enables students to broaden and deepen their consideration of basic human values and their interpretation of the experiences of human beings.

The humanities are concerned with questions of human existence and the universality of human life, questions of meaning and the nature of thinking and knowing, and questions of moral, aesthetic, and other human values. The humanities investigate these questions in both the present and the past and make use of philosophy, foreign languages, linguistics and communications studies, religious studies, literature, and fine arts.

Arizona General Education Curriculum

The fine arts constitute the artist's creative deliberation about reality, meaning, knowledge, and values.

Social and Behavioral Sciences [SB] 6 credits

A total of six (6) semester credits must be completed with a grade of C or better in the Social and Behavioral Sciences Core Area. Students are encouraged to choose coursework from more than one discipline for a total of six (6) semester credits.

The Social and Behavioral Sciences Core Area provides scientific methods of inquiry and empirical knowledge about human behavior, both within society and within individuals. The forms of study may be cultural, economic, geographic, historical, linguistic, political, psychological, or social. The courses in this area address the challenge of understanding the diverse natures of individuals and cultural groups who live together in a world of diminishing economic, linguistic, military, political, and social distance.

Natural Sciences [SQ/SG] 8 credits

A total of eight (8) semester credits must be completed with a grade of C or better in the Natural Sciences Core Area. The courses selected must include or be accompanied by the corresponding laboratory course. When the lecture and corresponding laboratory receive separate credit, both will be counted as equivalent to one course in that prefix.

Courses in the Natural Sciences Core Area help the student to develop an appreciation of the scope and limitations of scientific capability to contribute to the quality of society. This Core Area emphasizes knowledge of methods of scientific inquiry and mastery of basic scientific principles and concepts, in particular those that relate to matter and energy in living and nonliving systems. Firsthand exposure to scientific phenomena in the laboratory is important in developing and understanding the concepts, principles, and vocabulary of science. At least one of the two laboratory courses required in the Natural Sciences Core Area must include an introduction to the fundamental behavior of matter and energy in physical or biological systems.

Natural Sciences - Quantitative [SQ] A and B

The AGEC-A and -B Natural Sciences Core Area requires one laboratory course in natural sciences that includes a substantial introduction to the fundamental behavior of matter and energy in physical or biological systems.

Natural Sciences - General [SG] A and B

The AGEC-A and -B Natural Sciences Core Area requires a second laboratory course in the natural sciences, for example, from anthropology, astronomy, biology, chemistry, experimental psychology, geology, microbiology, physical anthropology, physical geography, physics, or plant biology.

Natural Sciences - Quantitative and General [SQ], [SG] S

The AGEC-S Natural Sciences Core Area requires eight (8) semester credits of either university chemistry **OR** eight (8) semester credits of university physics **OR** eight (8) semester credits of general biology appropriate to the major.

SQ = Natural Science - Quantitative

SG = Natural Science - General

AWARENESS AREAS

Students must satisfy two Awareness Areas: Cultural Diversity in U.S. and either Global Awareness or Historical Awareness. Courses can satisfy a Core Area and one or two Awareness Areas simultaneously. Therefore, no additional semester credits are required to satisfy the two Awareness Areas.

Cultural Diversity in the United States [C]

The contemporary culture of the United States involves the complex interplay of many different cultures that exist side by side in various

states of harmony and conflict. U.S. history involves the experiences not only of different groups of European immigrants and their descendants, but also of diverse groups of American Indians, Hispanic Americans, African Americans and Asian Americans—all of whom played significant roles in the development of contemporary culture and together shape the future of the United States. At the same time, the recognition that gender, class, and religious differences cut across all distinctions of race and ethnicity offers an even richer variety of perspectives from which to view oneself. Awareness of cultural diversity and its multiple sources can illuminate the collective past, present, and future and can help to foster greater mutual understanding and respect.

The objective of the Cultural Diversity area requirement is to promote awareness of and appreciation for cultural diversity within the contemporary United States. This is accomplished through the study of the cultural, social, or scientific contributions of women and minority groups, examination of their experiences in the United States, or exploration of successful or unsuccessful interactions between and among cultural groups.

Global Awareness [G]

Human organizations and relationships have evolved from being family and village centered to the modern global interdependence that is apparent in many disciplines—for example, contemporary art, business, engineering, music, and the natural and social sciences. Many serious local and national problems are world issues that require solutions which exhibit mutuality and reciprocity. These problems occur in a wide variety of activities, such as food supply, ecology, health care delivery, language planning, information exchange, economic and social developments, law, technology transfer, and even philosophy and the arts. The Global Awareness Area recognizes the need for an understanding of the values, elements, and social processes of cultures other than the culture of the United States. The Global Awareness Area includes courses that recognize the nature of other contemporary cultures and the relationship of the American cultural system to generic human goals and welfare.

Courses that satisfy the global awareness option in the requirements are of one or more of the following types:

1. Area studies that are concerned with an examination of culture-specific elements of a region of the world;
2. The study of a non-English language;
3. Studies of international relationships, particularly those in which cultural change is facilitated by such factors as social and economic development, education, and the transfer of technology; and
4. Studies of cultural interrelationships of global scope such as the global interdependence produced by problems of world ecology.

Historical Awareness [H]

The Historical Awareness Area option in the requirements aims to develop a knowledge of the past that can be useful in shaping the present and future. Because historical forces and traditions have created modern life and lie just beneath its surface, historical awareness is an aid in the analysis of present-day problems. Also, because the historical past is a source of social and national identity, historical study can produce intercultural understanding by tracing cultural differences to their origins. Even the remote past may have instructive analogies for the present.

The Historical Awareness Area consists of courses that are historical in method and content. In this area, the term *history* designates a sequence of past events or a narrative whose intent or effect is to represent such a sequence.

The requirement presumes that these are human events and that history includes all that has been felt, thought, imagined, said, and done by human beings. History is present in the languages, art, music, literature, philosophy, religion, and the natural sciences, as well as in the social science traditionally called history.

MCCCD COURSES THAT CAN BE USED TO SATISFY MCCCD AGEC-A, AGEC-B AND/OR AGEC-S

The Arizona General Education Curriculum (AGEC) is a 35-semester credit general education certificate that fulfills lower-division general education requirements for students planning to transfer to any Arizona public community college or university. There are three types of MCCCD AGECs. They are the AGEC A, AGEC B, and the AGEC S. Designed to articulate with different academic majors, the requirements vary accordingly.

The following is a list of courses supporting the MCCCD AGEC A, AGEC B and/or AGEC S general education requirements. This list is also referred to as the MCCCD general education course matrix and includes the following: course prefix/number, credits, title, general education designations, and notes related to policies and/or courses. Due to the dynamic nature of curriculum, course information is subject to change.

This list contains single courses and course combinations. Course combinations are multiple courses that must be taken to meet the general education designation. For course combinations, the general education areas satisfied by the combined courses is listed at the end of the combination. For example, GLG110 & GLG111 combined satisfy Natural Sciences [SG] in the Core Area.

The MCCCD Curriculum Office maintains this information on an ongoing basis. Before registering for any of the courses listed below, students are advised to access the most up-to-date information on general education designations at the following web address:

www.maricopa.edu/academic/curric/cphb/hb_academic.php
Select Matrix of MCCCD Courses

Courses that have been processed and have gained a general education designation will be listed on the MCCCD Curriculum Office Matrix for users to access in the process of advising students for transfer and curricular purposes.

Please be aware of the following general education policy that allows students to complete the Core and Awareness areas in the AGECs without exceeding 35 semester credits:

1. Courses can satisfy a Core Area and one or two Awareness Areas simultaneously.
2. A course cannot be used to satisfy more than one Core Area requirement.

Students should consult an SCC Academic Advisor to ensure appropriate course selection for general education purposes and transfer.

Course #	Cr	Course Title	Areas	Course #	Cr	Course Title	Areas
AFR110	3	Introduction to African-American Studies	C, SB	ASB214	3	Magic, Witchcraft and Healing	G, SB
AFR202	3	Ethnic Relations in the United States	C, H, SB*	ASB220	3	Archaeology Goes to the Movies	HU
AFR203	3	African-American History: The Slavery Experience	C, H, SB	ASB222	3	Buried Cities and Lost Tribes: Old World	G, H, HU, SB
AFR204	3	African-American History: Reconstruction to the Present	C, H, SB	ASB223	3	Buried Cities and Lost Tribes: New World	G, H, HU, SB
AGB139	3	Agribusiness Computer Operations	CS	ASB230	3	Principles of Archaeology	SB
AGS164	4	Plant Growth and Development	SG/SQ-A, B	ASB231	4	Intro to Archaeological Field Methods	SG-A, B
AIS101	3	Survey of American Indian Issues	C, H, SB	ASB235	3	Southwest Archaeology	C, H, SB
AIS105	3	Introduction to American Indian Studies	C, SB	ASB238	3	Archaeology of North America	H, SB
AIS110	3	Navajo Government	C	ASB245	3	Indians of the Southwest	C, H, SB
AIS140	3	American Indian History	C, H, SB	ASM104	4	Bones, Stones and Human Evolution	H, SB, SG-A, B
AIS141	3	Sovereign Indian Nations	C, H, SB	ASM265	4	Laboratory Methods in Archaeology	SG-A, B
AIS160	3	American Indian Law	C	AST101	3	Survey of Astronomy AND	
AIS170	3	American Indian History of the Southwest	C, H, SB	AST102	1	Survey of Astronomy Laboratory	SG-A, B
AIS213	3	American Indian Religions	C, HU, L	AST111	3	Introduction to Astronomy I AND	
AJS119	3	Computer Applications in Justice Studies	CS	AST113	1	Astronomy I Laboratory	SG/SQ-A, B
AJS123	3	Ethics and Administration of Justice	HU	AST112	3	Introduction to Astronomy II AND	
AJS162	3	Domestic Violence	SB	AST114	1	Astronomy II Laboratory	SG/SQ-A, B
AJS200	3	Current Issues in Criminal Justice	SB	BIO100	4	Biology Concepts	SG/SQ-A, B
AJS225	3	Criminology	SB	BIO101	4	Gen Bio (Non-Majors) Selected Topics	SG/SQ-A, B
AJS258	3	Victimology and Crisis Management	C, SB	BIO102	4	Gen Bio (Non-Majors) Additional Topics	SG/SQ-A, B
AJS270	3	Community Relations	C, SB	BIO105	4	Environmental Biology	SG/SQ-A, B
AMS150	4	Digital Systems and Microprocessors	CS	BIO107	4	Introduction to Biotechnology	G, SQ-A, B
ARB201	4	Intermediate Arabic I	G	BIO108	4	Plants and Society	G, SG/SQ-A, B
ARB202	4	Intermediate Arabic II	G	BIO109	4	Natural History of the Southwest	SG-A, B
ARH100	3	Introduction to Art	HU	BIO145	4	Marine Biology	SG-A, B
ARH101	3	Prehistoric Through Gothic Art	G, H, HU	BIO156	4	Human Biology for Allied Health	SG-A, B
ARH102	3	Renaissance Through Contemporary Art	G, H, HU	BIO160	4	Intro to Human Anatomy and Physiology	SG-A, B
ARH115	3	History of Photography	HU	BIO181	4	General Biology (Majors) I	SG/SQ-A, B, S
ARH118	3	Introduction to Chinese Art	G, HU	BIO182	4	General Biology (Majors) II	SG-A, B, S
ARH145	3	History of American Indian Art	C, HU	BIO219	4	Geographic Info Sys/GPS in Environmental Investigations	CS
ARH201	3	Art of Asia	G, H, HU	BIO201	4	Human Anatomy and Physiology I	SG-A, B
ARH203	3	Art of Ancient Egypt	H, HU	BIO205	4	Microbiology	SG-A, B
ARH217	3	Mexican Art History	H, HU	BIO241	4	Human Genetics	SG-A, B
ASB102	3	Intro to Cultural and Social Anthropology	G, SB	BPC110	3	Computer Usage and Applications	CS
ASB202	3	Ethnic Relations in the United States	C, H, SB	BPC217AM	3	Adv. Microsoft Access: Database Management	CS
ASB211	3	Women in Other Cultures	G, HU, SB	CCS101	3	Chicana and Chicano Studies	C, L

General Education Designations

C	Cultural Diversity in the United States	MA-A, B	Mathematical Studies, AGEC A & B
CS	Computer/Statistics/Quantitative Applications	MA-A, B & S	Mathematical Studies, AGEC A, B & S
FYC	First-Year Composition	SB	Social and Behavioral Sciences
G	Global Awareness	SG-A, B	Sciences-General AGEC-A & B
H	Historical Awareness	SG-A, B & S	Sciences-General AGEC-A, B & S
HU	Humanities and Fine Arts	SG/SQ-A, B & S	Sciences-General & Sciences-Quantitative AGEC-A, B & S
L	Literacy and Critical Inquiry	SQ-A, B	Sciences-Quantitative AGEC-A & B
MA-A	Mathematical Studies, AGEC A	SQ-A, B & S	Sciences-Quantitative AGEC-A, B & S

KEY: / = or & = and
*General Education designation effective Spring 2006.

Arizona General Education Curriculum Courses

Course #	Cr	Course Title	Areas	Course #	Cr	Course Title	Areas
CFS157	3	Marriage and Family Life	SB	CSC200AB	4	Principles of Computer Science (Java)	CS
CFS159	3	The Modern Family	SB	CSC210	3	Data Structures and Algorithms (Java)	CS
CFS176	3	Child Development	SB	CSC210AA	3	Data Structures and Algorithms (Java)	CS
CFS205	3	Human Development	SB	CSC210AB	4	Data Structures and Algorithms (Java)	CS
CFS242	3	Curriculum Planning for Diversity	C	DAH100	3	Introduction to Dance	G, HU
CFS259	3	Sexuality Over the Life Span	SB	DAH201	3	World Dance Perspectives	G, HU
CHI201	5	Intermediate Chinese I	G	DFT105	3	Computer Aided Drafting I	CS
CHI202	5	Intermediate Chinese II	G	DFT253	3	Computer Aided Drafting IIA	CS
CHM107	3	Chemistry and Society	G	ECE102	2	Engineering Analysis Tools and Techniques AND	
CHM107	3	Chemistry and Society AND		ECE103	2	Engineering Problem Solving and Design	CS
CHM107LL	1	Chemistry and Society Lab	G, SG/SQ-A, B	ECE102	2	Engineering Analysis Tools and Techniques AND	
CHM130	3	Fundamental Chemistry AND		ECE103AB	2	Engineering Problem Solving and Design	CS
CHM130LL	1	Fundamental Chemistry Lab	SG/SQ-A, B	ECE102AA	2	Engineering Analysis Tools and Techniques AND	
CHM150	4	General Chemistry I AND		ECE103	2	Engineering Problem Solving and Design	CS
CHM151LL	1	General Chemistry I Lab	SQ-A, B, S	ECE102AA	2	Engineering Analysis Tools and Techniques AND	
CHM151	3	General Chemistry I AND		ECE103AB	2	Engineering Problem Solving and Design	CS
CHM154LL	1	General Chemistry II Lab	SG/SQ-A, B, S	ECH176	3	Child Development	SB
CHM152	3	General Chemistry II AND		ECN111	3	Macroeconomic Principles	SB
CHM152LL	1	General Chemistry II Lab	SG/SQ-A, B, S	ECN112	3	Microeconomic Principles	SB
CHM154	3	General Chemistry II with Qual AND		ECN160	3	Economic History of United States	H, SB
CHM154LL	2	General Chemistry II with Qual Lab	SG/SQ-A, B, S	ECN212	3	The World Economy	G, SB
CHM230	3	Fundamental Organic Chemistry AND		ECN250	3	World Economic Systems	G, SB
CHM230LL	1	Fundamental Organic Chemistry Lab	SG/SQ-A, B	EDU221	3	Introduction to Education	SB
CIS105	3	Survey of Computer Information Systems	CS	EDU222	3	Introduction to the Exceptional Learner	C, SB
CIS158	3	COBOL Programming I	CS	EDU225	3	Foundations/Approaches to Serving English Language Learners (ELL)	C
CIS159	3	Visual Basic Programming I	CS	EDU230	3	Cultural Diversity in Education	C
CIS162	3	C Programming I	CS	EDU235	3	Mexican-American Child in Classroom	C
CIS162AA	3	C: Level I	CS	EDU291	3	Children's Literature	HU
CIS162AB	3	C++: Level I	CS	EDU292	3	The Art of Storytelling	C, HU
CIS162AC	3	Visual C++: Level I	CS	EDU294	3	Multicultural Folktales	C, HU
CIS162AD	3	C#: Level I	CS	ELE131	3	Digital Logic and Circuits AND	
CIS163AA	3	Java Programming: Level I	CS	ELE241	4	Microprocessor Concepts	CS
CIS169	3	Introduction to Visual Basic for Applications	CS	ELE150	4	Digital Systems and Microprocessors	CS
CIS175JA	3	Java Programming for Non-C Programmers	CS	ELT241	4	Microcontrollers	CS
CIS217AM	3	Adv. Microsoft Access: Database Management	CS	ELT282	4	Structured Assembly Language Programming	CS
CIS259	3	Visual Basic Programming II	CS	EMT258	3	Victimology and Crisis Management	C, SB
CIS262	3	C Programming II	CS	ENG101	3	First-Year Composition	FYC
CNS101	3	Construction and Culture	G, H, HU	ENG102	3	First-Year Composition	FYC
COM100	3	Intro to Human Communication	SB	ENG107	3	First-Year Composition for ESL	FYC
COM100AA	1	Intro Human Communication, Part I AND		ENG108	3	First-Year Composition for ESL	FYC
COM100AB	1	Intro Human Communication, Part II AND		ENG111	3	Technical Writing	L
COM100AC	1	Intro Human Communication, Part III	SB	ENG200	3	Reading and Writing About Literature	HU, L
COM110	3	Interpersonal Communication	SB	ENG213	3	Introduction to the Study of Language	L
COM110AA	1	Interpersonal Communication, Part I AND		ENG215	3	Strategies of Academic Writing	L
COM110AB	1	Interpersonal Communication, Part II AND		ENG216	3	Persuasive Writing on Public Issues	L
COM110AC	1	Interpersonal Communication, Part III	SB	ENG217	3	Personal and Exploratory Writing	L
COM207	3	Introduction to Communication Inquiry	L	ENG218	3	Writing About Literature	L
COM222	3	Argumentation	L	ENG260	3	Film Analysis	HU
COM225	3	Public Speaking	L	ENH110	3	Introduction to Literature	C, HU
COM230	3	Small Group Communication	L, SB	ENH112	3	Chicano Literature	C, HU
COM241	3	Performance of Literature	HU, L	ENH113	3	Writers and Current Issues	HU
COM250	3	Intro to Organizational Communication	SB	ENH114	3	African-American Literature	C, HU
COM263	3	Elements of Intercultural Communication	C, G, SB	ENH201	3	World Literature Through Renaissance	G, H, HU
CPD160	3	Introduction to Multiculturalism	C	ENH202	3	World Literature After Renaissance	G, H, HU
CRE101	3	Critical and Evaluative Reading I	L	ENH204	3	Introduction to Contemporary Literature	HU
CSC100	3	Intro to Computer Science for Non-Computer Majors	CS	ENH205	3	Asian American Literature	C, HU
CSC100AA	3	Intro to Computer Science for Non-Computer Majors	CS	ENH206	3	Nature and Environmental Literature	HU
CSC100AB	4	Intro to Computer Science (C++)	CS	ENH214	3	Poetry Study	HU
CSC110	3	Intro to Computer Science for Majors	CS	ENH221	3	Survey of English Literature Before 1800	HU
CSC110AA	3	Intro to Computer Science for Majors	CS	ENH222	3	Survey of English Literature After 1800	H, HU
CSC110AB	4	Intro to Computer Science (Java)	CS	ENH230	3	Introduction to Shakespeare	HU
CSC150	3	Programming in C/C++	CS	ENH241	3	American Literature Before 1860	HU
CSC150AA	4	Programming in C/C++	CS	ENH242	3	American Literature After 1860	HU
CSC180	3	Computing for Scientists, Eng. & Med/Health Spec.	CS	ENH250	3	Classical Backgrounds in Literature	HU
CSC180AA	3	Computing for Scientists, Eng. & Med/Health Spec.	CS	ENH251	3	Mythology	G, HU
CSC180AB	4	Computing for Scientists, Eng. & Med/Health Spec.	CS	ENH254	3	Literature and Film	HU, L
CSC181	3	Applied Problem Solving with Visual Basic	CS	ENH255	3	Contemporary U.S. Literature and Film	C, HU, L
CSC181AA	3	Applied Problem Solving with Visual Basic	CS	ENH256	3	Shakespeare on Film	HU
CSC181AB	4	Applied Problem Solving with Visual Basic	CS	ENH259	3	American Indian Literature	C, HU
CSC183	3	Applied Problem Solving with Fortran	CS	ENH260	3	Literature of the Southwest	C, HU
CSC200	3	Principles of Computer Science (Java)	CS	ENH270	3	19th Century American Fiction	HU
CSC200AA	3	Principles of Computer Science (Java)	CS	ENH275	3	Modern Fiction	HU

KEY: / = or & = and

*General Education designation effective Spring 2006.

Arizona General Education Curriculum Courses

Course #	Cr	Course Title	Areas	Course #	Cr	Course Title	Areas
ENH284	3	19th Century Women Writers	C, HU	HIS103	3	United States History to 1870	H, HU*, SB
ENH285	3	Contemporary Women Writers	C, HU	HIS104	3	United States History 1870 to Present	H, SB
ENH289	3	Literature from Contemporary Nobel Laureates	HU	HIS105	3	Arizona History	H, SB
ENH291	3	Children's Literature	HU	HIS105AA	1	Arizona History, Part I AND	
ENH294	3	Multicultural Folktales	C, HU	HIS105AB	1	Arizona History, Part II AND	
ENH295	3	Banned Books and Censorship	C, HU	HIS105AC	1	Arizona History, Part III	H, SB
FON143	3	Food and Culture	G	HIS106	3	Southwest History	C, H, SB
FON241	3	Principles of Human Nutrition	*SG-A, B	HIS108	3	U.S. History 1945 to the Present	C, H, SB
FOR105	4	Forensic Science: Physical Evidence	*SQ-A, B	HIS109	3	Mexican American History and Culture	C, H, SB
FRE201	4	Intermediate French I	G	HIS110	3	World History to 1500	G, H, SB
FRE201AA	4	Intermediate French I	G	HIS111	3	World History 1500 to the Present	G, H, HU*, SB
FRE202	4	Intermediate French II	G	HIS113	3	History of Eastern Civilizations to 1850	G, H, SB
FRE202AA	4	Intermediate French II	G	HIS114	3	History of Eastern Civilizations 1850 to Present	G, H, SB
FRE265	3	Advanced French I	G, HU	HIS135	3	Military History of the Southwest	H, SB
FRE266	3	Advanced French II	G, HU	HIS140	3	American Indian History	C, H, SB
FSC258	3	Victimology and Crisis Management	C, SB	HIS145	3	History of Mexico	G, H, SB
GBS220	3	Quantitative Methods in Business	MA-A	HIS170	3	American Indian History of the Southwest	C, H, SB
GBS221	3	Business Statistics	CS	HIS173	3	United States Military History	H, SB
GBS233	3	Business Communication	L	HIS201	3	History of Women in America	C, H, SB
GBS280	3	Organizational Psychology	SB	HIS203	3	African-American History I	C, H, SB
GCU102	3	Introduction to Human Geography	G, SB	HIS204	3	African-American History II	C, H, SB
GCU121	3	World Geography: Eastern Hemisphere	G, SB	HIS209	3	The Chicano in 20th Century America	C, H, SB
GCU122	3	World Geography: Western Hemisphere	G, SB	HIS241	3	Latin American Civ in the Colonial Period	H, SB
GCU141	3	Introduction to Economic Geography	G, SB	HIS242	3	Latin American Civ Post-Colonial Period	G, H, SB
GCU221	3	Arizona Geography	C, H, SB	HIS243	3	World Religions	G, H, HU
GCU223	3	Geography of Latin America	G, SB	HIS245	3	Geostrategy in History and Future	H*, SB*
GCU253	3	Intro/Cultural and Historical Geography	G, SB	HIS251	3	History of England to 1700	H, SB
GER201	4	Intermediate German I	G	HIS252	3	History of England: 1700 to Present	H, SB
GER201AA	4	Intermediate German I	G	HIS272	3	History of the Far East: 1900 to Present	G, H, SB
GER202	4	Intermediate German II	G	HIS273	3	U. S. Experience in Vietnam: 1945-1975	G, H, SB
GER202AA	4	Intermediate German II	G	HIS277	3	The Modern Middle East	G, H, SB
GLG101	3	Intro to Geology I-Physical Lecture	G	HUM101	3	General Humanities	HU
GLG101	3	Intro to Geology I-Physical Lecture AND					
GLG103	1	Intro to Geology I-Physical Lab	G, SG/SQ-A, B				
GLG102	3	Intro to Geology II-Historical Lecture	H				
GLG102	3	Intro to Geology II-Historical Lecture AND					
GLG104	1	Intro to Geology II-Historical Lab	H, SG-A, B				
GLG105	4	Introduction to Planetary Science	SG-A, B				
GLG110	3	Geologic Disasters and the Environment	G				
GLG110	3	Geologic Disasters and the Environment AND					
GLG111	1	Geologic Disasters and the Environment Lab	G, SG-A, B				
GPH111	4	Introduction to Physical Geography	SG/SQ-A, B				
GPH112	3	Introduction to Physical Geography AND					
GPH113	1	Introduction to Physical Geography Lab	SG/SQ-A, B				
GPH210	3	Introduction to Environmental Geography	G				
GPH211	3	Landform Processes	L				
GPH212	3	Introduction to Meteorology I AND					
GPH214	1	Introduction to Meteorology Lab I	SG/SQ-A, B				
GPH213	3	Introduction to Climatology AND					
GPH215	1	Introduction to Climatology Lab	**SG-A, B				
GPH220	3	Intro/Geographic Information Systems	CS				
HCR210	3	Clinical Health Care Ethics	HU				
HCR220	3	Health Care Organizations	H				
HCR230	3	Culture and Health	C, G				
HEB201	4	Intermediate Hebrew I	G				
HEB202	4	Intermediate Hebrew II	G				
HES100	3	Healthful Living	SB				
HIS100	3	History Western Civ to Middle Ages	H, SB				
HIS101	3	History Western Civ/Middle Ages-1789	H, HU*, SB				
HIS102	3	History Western Civ/1789 to Present	G, H, HU*, SB				

(Note: Three (3) of the five (5) HUM105 modules must be taken to secure [C, HU] credit.)

HUM105AA	1	Cultural Perspective: African Ideas/Values	C, HU
HUM105AB	1	Cult Perspective: Native-American Ideas/Values	C, HU
HUM105AC	1	Cult Perspective: Asian Ideas/Values	C, HU
HUM105AD	1	Cult Perspective: Hispanic Ideas/Values	C, HU
HUM105AE	1	Cult Perspective: Mid-Eastern Ideas/Values	C, HU
HUM107	3	Humanities Through the Arts	HU
HUM108	3	Contemporary Humanities	H, HU
HUM120	3	Cultural Viewpoints in the Arts	C, HU
HUM125	3	The Urban Experience	HU

(Note: Three (3) of the nine (9) HUM190 modules must be taken to secure [HU] credit.)

HUM190AA-AI	1	Honors Forum	HU
HUM201	3	Humanities: Universal Themes	G, HU
HUM202	3	Humanities: Universal Themes	G, HU
HUM205	3	Introduction to Cinema	H, HU
HUM206	3	Introduction to Television Arts	HU
HUM208	3	Arts and World Views of the Southwest	C, HU
HUM209	3	Women and Films	C, H, HU
HUM210	3	Contemporary Cinema	HU
HUM211AA	3	Foreign Films: Classics	G, HU
HUM211AB	3	Foreign Films: Japanese	G, HU
HUM211AC	3	Foreign Films: French	G, HU
HUM213	3	Hispanic Film	G, HU
HUM214	3	African-Americans in Film	C, HU
HUM250	3	Ideas and Values in the Humanities	H, HU, L
HUM251	3	Ideas and Values in the Humanities	H, HU, L

General Education Designations

C Cultural Diversity in the United States
 CS Computer/Statistics/Quantitative Applications
 FYC First-Year Composition
 G Global Awareness
 H Historical Awareness
 HU Humanities and Fine Arts
 L Literacy and Critical Inquiry
 MA-A Mathematical Studies, AGEC A

MA-A, B Mathematical Studies, AGEC A & B
 MA-A, B & S Mathematical Studies, AGEC A, B & S
 SB Social and Behavioral Sciences
 SG-A, B Sciences-General AGEC-A & B
 SG-A, B & S Sciences-General AGEC-A, B & S
 SG/SQ-A, B & S Sciences-General & Sciences-Quantitative AGEC-A, B & S
 SQ-A, B Sciences-Quantitative AGEC-A & B
 SQ-A, B & S Sciences-Quantitative AGEC-A, B & S

KEY: / = or & = and

*General Education designation effective Spring 2006.

**General Education designation effective Summer 2005.

Arizona General Education Curriculum Courses

Course #	Cr	Course Title	Areas
HUM260	3	Intercultural Perspectives	C, HU
HUM261	3	Asian Ideas and Values	G, H, HU
HUM292	3	The Art of Storytelling	C, HU
IBS101	3	Introduction to International Business	G
IBS109	3	Cultural Dimensions of International Trade	G, SB
IFS101	3	Information Skills in the Digital Age	L
IGS291	3	Studies in Global Awareness	G, L
IGS292	3	Studies in Cultural Diversity	C
IGS293	3	Studies in Historical Awareness	H, L
INT105	3	Introduction to Interior Design	G, HU
INT115	3	Historical Architecture and Furniture	H, HU
INT120	3	Modern Architecture and Furniture	H, HU
INT225	3	History of Decorative Arts	HU
ITA201	4	Intermediate Italian I	G
ITA201AA	4	Intermediate Italian I	G
ITA202	4	Intermediate Italian II	G
ITA202AA	4	Intermediate Italian II	G
ITA226	4	Intermediate Italian Conversation II	G
JAS225	3	Statistics for Social Research/Justice & Government	CS
JPN201	5	Intermediate Japanese I	G
JPN202	5	Intermediate Japanese II	G
JRN201	3	News Writing	L
JRN212	3	Broadcast Writing	L
JRN234	3	Feature Writing	L
LAT201	4	Intermediate Latin I	HU
LAT202	4	Intermediate Latin II	HU
MAT140	5	College Mathematics	MA-A
MAT141	4	College Mathematics	MA-A
MAT142	3	College Mathematics	MA-A
MAT150	5	College Algebra/Functions	MA-A
MAT151	4	College Algebra	MA-A
MAT151AA	1	College Algebra I AND	
MAT151AB	1	College Algebra II AND	
MAT151AC	1	College Algebra III AND	
MAT151AD	1	College Algebra IV	MA-A
MAT152	3	College Algebra	MA-A
MAT172	3	Finite Mathematics	MA-A
MAT150 OR MAT151 OR MAT152 AND			
MAT182	3	Plane Trigonometry	MA-A
MAT187	5	Precalculus	MA-A
MAT206	3	Elements of Statistics	CS
MAT212	3	Brief Calculus	MA-A, B
MAT213	4	Brief Calculus	MA-A, B
MAT216	3	Technical Calculus I	MA-A, B
MAT220	5	Analytic Geometry and Calculus I	MA-A, B, S
MAT221	4	Calculus with Analytic Geometry I	MA-A, B, S
MAT225	3	Elementary Linear Algebra	MA-A, B
MAT226	3	Technical Calculus II	MA-A, B
MAT227	3	Discrete Mathematical Structures	MA-A, B
MAT230	5	Analytic Geometry and Calculus II	MA-A, B, S
MAT231	4	Calculus with Analytic Geometry II	MA-A, B, S
MAT236	3	Technical Calculus III	MA-A, B
MAT240	5	Calculus with Analytic Geometry III	MA-A, B, S
MAT241	4	Calculus with Analytic Geometry III	MA-A, B, S
MAT251	4	Calculus for Life Science	MA-A, B, S
MAT261	4	Differential Equations	MA-A, B, S
MAT262	3	Differential Equations	MA-A, B
MCO120	3	Media and Society	SB
MCO220	3	Cultural Diversity and the Media	C, L
MHL140	3	Survey of Music History	H, HU
MHL143	3	Music in World Cultures	G, HU
MHL145	3	American Jazz and Popular Music	C, HU
MHL146	3	Survey of Broadway Musicals	HU
MHL147	3	Music of African-American Cultures	HU
MHL153	3	Rock Music and Culture	H, HU
MHL155	3	Survey of American Music	C, H, HU
PHI101	3	Introduction to Philosophy	HU
PHI102	3	Introduction to Philosophy	HU
PHI103	3	Introduction to Logic	HU, L
PHI104	3	World Philosophy	G, HU
PHI105	3	Introduction to Ethics	HU
PHI106	3	Critical Thinking and Problem Solving	HU, L

Course #	Cr	Course Title	Areas
PHI109	3	Philosophy of the Arts	HU
PHI201	3	History of Ancient Philosophy	H, HU
PHI212	3	Contemporary Moral Issues	HU
PHI213	3	Medical and Bio-Ethics	HU
PHI216	3	Environmental Ethics	G, HU
PHI218	3	Philosophy of Sexuality	HU
PHI224	3	Political Philosophy	HU
PHI225	3	African-American Religions	C, HU
PHI233AA	3	Metaphysics: An Introduction	HU
PHI233AB	3	Theory of Knowledge	HU
PHI234AA	3	Plato	HU
PHI243	3	World Religions	G, H, HU
PHI244	3	Philosophy of Religion	HU
PHI245	3	Introduction to Eastern Philosophy	G, HU
PHI246	3	Amer Indian Euroamer Comparative Worldviews	HU
PHS110	4	Fundamentals of Physical Science	SG/SQ-A, B
PHS120	4	Introduction to Physical Science	G, SG/SQ-A, B
PHY101	4	Introduction to Physics	SG/SQ-A, B
PHY111	4	General Physics I	SG/SQ-A, B
PHY112	4	General Physics II	SG/SQ-A, B
PHY115	5	University Physics I	SG/SQ-A, B, S
PHY116	5	University Physics II	SG/SQ-A, B, S
PHY121	4	Univ Physics I: Mechanics	SG/SQ-A, B, S
PHY131	4	Univ Physics II: Electricity & Magnetism	SG/SQ-A, B, S
PHY252	4	Univ Phys III: Thermo Dynamics, Opti/Wave Phen	SG/SQ-A, B
POR102	5	Elementary Portuguese II	G
POR201	5	Intermediate Portuguese I	G
POR202	5	Intermediate Portuguese II	G
POS100	3	Introduction to Political Science	SB
POS110	3	American National Government	SB
POS115	3	Issues in American Politics	L, SB
POS120	3	World Politics	G, SB
POS125	3	Issues in World Politics	G, SB
POS130	3	State and Local Government	SB
POS140	3	Comparative Government	G, SB
POS180	3	United Nations Study	G
POS210	3	Political Ideologies	SB
POS223	3	Civil Rights	C, SB
POS285	3	Public Policy	SB
PSY101	3	Introduction to Psychology	SB
PSY132	3	Psychology and Culture	C, G, SB
PSY143	3	Lesbian, Gay and Bisexual Studies	C
PSY157	3	African/Black Psychology	C, G, SB
PSY215	3	Introduction to Sport Psychology	SB
PSY218	3	Health Psychology	SB
PSY225	3	Psychology of Religion	C, G, SB
PSY230	3	Introduction to Statistics	CS
PSY235	3	Psychology of Gender Differences	C, SB
PSY240	3	Developmental Psychology	SB
PSY245	3	Psychology of Adult Development	SB
PSY250	3	Social Psychology	SB
PSY258	3	Domestic Problems and Crises	SB
PSY260	3	Psychology of Personality	SB
PSY266	3	Abnormal Psychology	SB
PSY270	3	Personal and Social Adjustment	SB
PSY277	3	Psychology of Human Sexuality	SB
PSY280	3	Organizational Psychology	SB
PSY290AB	4	Research Methods	L, SG-A, B
PSY290AC	4	Research Methods	L, SG-A, B
PSY292	3	Psychology of Altered States of Consciousness	SB
REC120	3	Leisure and the Quality of Life	SB
REC160	3	Leisure and Society	SB
REL101	3	Introduction to Religion	HU
REL201	3	Classics of Western Religions	H, HU
REL202	3	Classics of Asian Religions	G, HU
REL203	3	American Indian Religions	C, HU, L
REL205	3	Religion and the Modern World	C, HU, L
REL213	3	Medical and Bio-Ethics	HU
REL225	3	African-American Religions	C, HU
REL243	3	World Religions	G, H, HU
REL244	3	Philosophy of Religion	HU
REL246	3	Amer Indian Euroamer Comparative Worldviews	HU

KEY: / = or & = and

*General Education designation effective Spring 2006.

Arizona General Education Curriculum Courses

Course #	Cr	Course Title	Areas	Course #	Cr	Course Title	Areas
REL250	3	History of Religion in Ireland	H, HU	THP241	3	Performance of Literature	HU, L
REL270	3	Introduction to Christianity	HU	WED110	3	Principles of Physical Fitness/Wellness	SB
REL271	3	Introduction to the New Testament	HU	WST100	3	Women and Society	C, SB
REL290	3	Women and Religion	G, HU	WST105	3	Women of Color in America	C, SB
RUS201	4	Intermediate Russian	G	WST110	3	Women and Gender: A Feminist Psychology	SB
RUS201AA	4	Intermediate Russian	G	WST120	3	Gender, Class and Race	SB
RUS202	4	Intermediate Russian	G	WST160	3	Women and the Early American Experience	C, H, SB
RUS202AA	4	Intermediate Russian	G	WST161	3	American Women since 1920	C, H, SB
SBU200	3	Society and Business	G, SB	WST209	3	Women and Films	C, H, HU
SMT150	4	Digital Systems and Microprocessors	CS	WST284	3	19th Century Women Writers	C, HU
SOC101	3	Introduction to Sociology	SB	WST285	3	Contemporary Women Writers	C, HU
SOC110	3	Drugs and Society	SB	WST290	3	Women and Religion	G
SOC130	3	Human Sexuality	SB	YAQ100	3	Yaqui Indian History and Culture	C, H, SB
SOC140	3	Racial and Ethnic Minorities	C, SB				
SOC141	3	Sovereign Indian Nations	C, H, SB				
SOC142	3	Sociology of the Chicano Community	C, SB				
SOC143	3	Sociology of Afro-American Problems	C, SB				
SOC157	3	Sociology of Marriage and Family	SB				
SOC160	3	American Indian Law	C				
SOC180	3	Social Implications of Technology	SB				
SOC210	3	The Child in Society	SB				
SOC212	3	Gender and Society	C, SB				
SOC215	3	Sociology of Adolescence	SB				
SOC240	3	Race and Ethnic Relations: American and Global Perspectives ...	C, SB				
SOC245	3	Social Deviance	SB				
SOC251	3	Social Problems	SB				
SOC253	3	Social Class and Stratification	SB				
SOC265	3	Sociology of Aging	SB				
SOC270	3	Sociology of Health and Illness	SB				
SPA201	4	Intermediate Spanish I	G				
SPA201AA	4	Intermediate Spanish I	G				
SPA202	4	Intermediate Spanish II	G				
SPA202AA	4	Intermediate Spanish II	G				
SPA203	4	Spanish for Spanish Speaking Students I	G				
SPA204	4	Spanish for Spanish Speaking Students II	G				
SPA241	3	Spanish and Spanish-American Film I	G, HU				
SPA242	3	Spanish and Spanish-American Film II	G, HU				
SPA265	3	Advanced Spanish I	HU				
SPA266	3	Advanced Spanish II	HU				
SPH150	3	Peninsular Spanish Lit in Translation	G, HU				
SPH151	3	Latin American Lit in Translation	G, HU				
SPH245	3	Hispanic Heritage in the Southwest	C, HU				
STO292	3	The Art of Storytelling	C, HU				
STO294	3	Multicultural Folktales	C, HU				
SWU102	3	Introduction to Social Work	H, SB				
SWU171	3	Introduction to Social Welfare	H, SB				
SWU258	3	Victimology and Crisis Management	C, SB				
SWU292	3	Effective Helping in a Diverse World	C, SB				
TCM145	3	Introduction to Motion Picture Production	HU				
TCM145	3	Introduction to Motion Picture Production AND					
THE205	3	Introduction to Cinema	H, HU				
TEC105	3	Clothing Selection	SB				
TEC106	3	History of Fashion	SB				
THE111	3	Introduction to Theatre	HU				
THE205	3	Introduction to Cinema	H, HU				
THE206	3	Introduction to Television Arts	HU				
THE210	3	Contemporary Cinema	HU				
THE220	3	Modern Drama	HU, L				
THE260	3	Film Analysis	HU				

University Transfer Guides

University Transfer Guides show how MCCCDC courses apply to specific Arizona public university degree requirements. The transfer guides are useful both for students pursuing an MCCCDC transfer associate degree which articulates with specific Arizona public university degrees, as well as for students pursuing Arizona public university degrees which do not articulate with an MCCCDC transfer associate degree. Information about transfer guides is available from an advisor or accessible on the following websites:

- Arizona State University Main/East:
<http://www.asu.edu/provost/articulation/>
- Arizona State University West:
<http://www.west.asu.edu/gowest/>
- Northern Arizona University:
<http://www.nau.edu/regis/transguide/info.htm>
- The University of Arizona:
<http://transferguides.arizona.edu/>

AZCAS Transfer Planning Guides

AZCAS Transfer Planning Guides are built from an institution's academic programs. Community college or university coursework that is self-entered into AZCAS is used to evaluate a student's progress toward a community college transfer certificate, community college transfer degree, and/or an Arizona public university degree. Information about the transfer planning guides is available from an advisor or accessible via the following web address:

- <http://az.transfer.org/cas/atass/index.html>
- Select *Student Information* followed by:
Course Applicability System (CAS)
Go to CAS!

General Education Designations

C	Cultural Diversity in the United States	MA-A, B	Mathematical Studies, AGECA & B
CS	Computer/Statistics/Quantitative Applications	MA-A, B & S	Mathematical Studies, AGECA, B & S
FYC	First-Year Composition	SB	Social and Behavioral Sciences
G	Global Awareness	SG-A, B	Sciences-General AGECA-A & B
H	Historical Awareness	SG-A, B & S	Sciences-General AGECA-A, B & S
HU	Humanities and Fine Arts	SG/SQ-A, B & S	Sciences-General & Sciences-Quantitative AGECA-A, B & S
L	Literacy and Critical Inquiry	SQ-A, B	Sciences-Quantitative AGECA-A & B
MA-A	Mathematical Studies, AGECA	SQ-A, B & S	Sciences-Quantitative AGECA-A, B & S

ASSOCIATE IN ARTS (AA) DEGREE

Description

The Maricopa County Community College District (MCCCD) Associate in Arts (AA) degree requires 60-64 semester credits for the program of study. The degree includes the following components: 1) General Education which includes Arizona General Education Curriculum for Arts (AGEC-A) and MCCCD Additional Requirements; and 2) General Electives.

Purpose of the Degree

The Associate in Arts degree is designed for students planning to transfer to four-year colleges and universities. In general, the components of the degree meet requirements for majors in the Liberal Arts or programs of study other than business or science. The degree will transfer as a block without loss of credit to Arizona's public universities and other institutions with district-wide articulation agreements.

The semester credits used to satisfy the MCCCD Associate in Arts will apply to university graduation requirements of the university major for which the Associate in Arts is designed. Information regarding the articulation of the Associate in Arts with majors at the Arizona public universities can be accessed via the following website:

<http://az.transfer.org/cas/atass/student/modpath.html>

Academic Policies that Govern the Associate in Arts Degree

- Completion of the Associate in Arts or the AGEC-A provides for exemption from Arizona public university admission requirements for Arizona residents who have a minimum Grade Point Average of 2.0 on a 4.0=A scale and a minimum 2.5 on a 4.0=A scale for nonresidents.
- The graduation policies within the general catalog must be satisfied for completion of the Associate in Arts degree.
- A minimum of 60 semester credits in courses numbered 100 and above to be completed with a grade of C or better.
- The General Education Requirements for AGEC-A may be completed in 35 semester credits with the following stipulations:
 1. Courses can satisfy a Core Area and one or two Awareness Areas simultaneously.
 2. A course cannot be used to satisfy more than one Core Area.
- General Education courses can satisfy multiple areas within the degree simultaneously (AGEC-A Core Area, AGEC Awareness Area, MCCCD Additional Requirements, or lower-division courses applicable to the major).
- Effective Fall 2000, the course evaluation and/or general education designation as listed in the Arizona Course Equivalency Guide (CEG) within the Arizona Course Applicability System (AZCAS) is valid for the **term** in which the student is awarded credit on the transcript. A course evaluation and/or general education designation may be subject to change. Students do have the option to petition for general education evaluations and/or general education designations upon transfer.
- Courses completed at one of the Maricopa Community Colleges to meet AGEC-A requirements must be listed in the Course Equivalency Guide within the Arizona Course Applicability System as an equivalent course, departmental elective credit (XXXXDEC), or general elective credit (Elective) at all Arizona public universities. The course's evaluation and/or general education designation is valid for the term in which the student is awarded credit on the transcript. See the list titled [MCCCD Courses That Can Be Used to Satisfy MCCCD AGEC-A, AGEC-B and/or AGEC-S](#), page 36, for specific course information.

The most up-to-date information can be accessed via the following web address:

<http://www.maricopa.edu/academic/curric/>

Select tab labeled *Curriculum Procedures Handbook - Programs*

Select *Academic Programs*

Select *Matrix of MCCCD Courses* (AGEC Course Matrix)

- Courses completed at one of the Maricopa Community Colleges to meet the General Electives requirement must be listed in the Course Equivalency Guide (CEG) within the Arizona Course Applicability System (AZCAS) as an equivalent course, departmental elective credit (XXXXDEC), or general elective credit (Elective) at all Arizona public universities. For appropriate course selection, students should consult with an advisor.
- Courses transferred from another regionally accredited institution to one of the Maricopa Community Colleges will be evaluated by the college for inclusion in the AGEC-A or Associate in Arts Degree.
- Courses and their modular equivalents will satisfy AGEC-A and Associate in Arts requirements.
- If a course is cross-referenced with one or more other courses, then only one of the cross-referenced courses will be accepted to meet requirements.

Degree Requirements

The 60-64 semester credits required for the Associate in Arts follow. See the list titled [MCCCD Courses That Can Be Used to Satisfy MCCCD AGEC-A, AGEC-B and/or AGEC-S](#), page 36, for specific course information. The most up-to-date information can be accessed via the following web address:

<http://www.maricopa.edu/academic/curric/>

Select tab labeled *Curriculum Procedures Handbook - Programs*

Select *Academic Programs*

Select *Matrix of MCCCD Courses* (AGEC Course Matrix)

This list identifies the courses in alpha-order by prefix as well as the Core Areas and Awareness Areas where the course will apply. For purposes of clarifying requirements in the Mathematics and Natural Sciences areas on the list and the AGEC requirements, an A, B and/or S character may follow the [MA], [SQ], [SG] general education designations and refers to the specific AGEC.

I. MCCCD General Education

Credits

The MCCCD General Education includes two areas:
MCCCD AGEC-A and MCCCD Additional Requirements.

A. MCCCD AGEC-A

35

I. Core Areas

- a. First-Year Composition (FYC) 6
 - b. Literacy and Critical Inquiry [L] 3
 - c. Mathematical Studies [MA/CS] 6
- To complete the Mathematical Studies requirement, select one course to satisfy the Mathematics [MA] A and a second course from Computer/Statistics/Quantitative Applications [CS].
- 1) Mathematics [MA] A (3 credits)
Note: Requires a course in college mathematics (MAT142) or college algebra (MAT150, MAT151, MAT152) or precalculus (MAT187) or any other mathematics course designated with the MA general education value and for which college algebra is a prerequisite.
- AND
- 2) Computer/Statistics/Quantitative Applications [CS] (3 credits)

Associate in Arts (AA) Degree

- d. Humanities and Fine Arts [HU] 6
Students are encouraged to choose course work from more than one discipline for a total of six (6) semester credits.
- e. Social and Behavioral Sciences [SB] 6
Students are encouraged to choose course work from more than one discipline for a total of six (6) semester credits.
- f. Natural Sciences [SQ/SG] 8
To complete the Natural Sciences requirement:
Select four (4) semester credits of [SQ] and four (4) semester credits of [SG] for a total of eight (8) semester credits, OR eight (8) semester credits of [SQ]. Students **cannot** take eight (8) semester credits of [SG] to meet the Natural Sciences requirement.

The lecture course(s) selected for Natural Sciences must include or be accompanied by the corresponding laboratory course. The lecture and corresponding laboratory course(s) may carry separate credit. Students should consult with an advisor for appropriate course selection. Students should also access the AZ Course Equivalency Guide (CEG) within the AZ Course Applicability System (AZCAS) for information on equivalencies.

2. Awareness Areas

Students must satisfy two Awareness Areas: Cultural Diversity in the United States [C] and either Global Awareness [G] or Historical Awareness [H]. However, it is not necessary for students to exceed thirty-five (35) semester credits to complete the Awareness Areas because courses can satisfy a Core Area and one or two Awareness Areas simultaneously. Therefore, no additional semester credits are required to satisfy the two Awareness Areas.

Cultural Diversity in the United States [C]
AND
Global Awareness [G]
OR
Historical Awareness [H]

B. MCCC Additional Requirements 0-6

Students must satisfy Oral Communication and Critical Reading areas. However, it is not necessary for students to exceed the thirty-five (35) semester credits required in order to complete the MCCC Additional Requirements because courses can satisfy a Core Area and MCCC Additional Requirements simultaneously. Therefore, no additional semester credits are required to satisfy Oral Communication and Critical Reading.

I. Oral Communication

A total of three (3) semester credits is required for Oral Communication. However, if students select a communication course that satisfies both the Oral Communication area and an area within the Core, then the Oral Communication requirement has been satisfied and additional electives may be taken.

Select from the following options:

COM100 [SB] (3 credits) OR
COM100AA & COM100AB & COM100AC [SB] (3 credits)
OR
COM110 [SB] (3 credits) OR
COM110AA & COM110AB & COM110AC [SB] (3 credits)
OR
COM225 [L] (3 credits) OR
COM230 [L] [SB] (3 credits)

2. Critical Reading

A total of three (3) semester credits is required for the Critical Reading area. However, if students complete CRE101 and apply it to AGEC-A Core Requirements or if students demonstrate proficiency through assessment, then the Critical Reading requirement has been satisfied and additional electives may be taken.

CRE101 [L] OR
equivalent as indicated by assessment

II. General Electives

Select courses to complete a minimum of 60 semester credits but no more than a total of 64 semester credits.

For students who have decided on a major that articulates with the AA, but who are undecided on the university to which they will transfer, courses satisfying the General Electives Area should be selected from the list of Common Courses, Arizona Transfer Pathway Guides, and/or University Transfer Guides in order for the courses to apply in the major upon transfer.

The list of Common Courses for each major is included in the Arizona Transfer Pathway Guides. University Transfer Guides are also available for the Arizona public universities. These guides, both statewide and institutional, are accessible on the following web site:

http://az.transfer.org/cas/students/transfer_guides.htm

Students must select MCCC courses that are acceptable as an equivalent course, departmental elective credit (XXXXDEC), or general elective credit (Elective) at all Arizona public universities according to the Arizona Course Equivalency Guide (CEG) within the Arizona Course Applicability System (AZCAS). For appropriate course selection, students should consult with an advisor.

For some majors, students must demonstrate 4th semester proficiency at the 202 course level to satisfy the Non-English Language Requirements. Students should consult the Arizona Transfer Pathway Guides and/or the University Transfer Guides to determine this requirement for the major at the university to which they intend to transfer. If required, it is recommended that students choose Maricopa courses as electives to meet this requirement as part of the Associate in Arts degree.

Students who are undecided on a major or university should consult an advisor. Not all majors have common courses, so it is recommended that students consult with an advisor for a list of common courses or assistance with selecting appropriate electives.

Associate in Arts Total Credits:

60-64

ASSOCIATE IN ARTS IN ELEMENTARY EDUCATION (AAEE) DEGREE

Description

The Maricopa County Community College District (MCCCD) Associate in Arts in Elementary Education (AAEE) requires the student to complete 60-63 semester credits in the program of study. The degree has two major components: 1) MCCCD General Education which includes the Arizona General Education Curriculum for Arts (AGEC-A) and Additional MCCCD Requirements; and 2) Elementary Education Requirements which includes Education Foundations and Electives for Arizona Professional Teacher Standards.

Purpose of the Degree

The AAEE is designed for the student who plans to transfer to an Elementary Education program at an Arizona public higher education institution and/or who plans to become a classroom instructional aide.

The degree transfers as a block without loss of credit to Arizona's public universities. All semester credits applied to the MCCCD Associate in Arts in Elementary Education also apply to graduation requirements of the university major for which the AAEE was designed, regardless of whether the credit was awarded for completion of course work or for prior learning. (For additional information on credit awarded for prior learning assessment, see the policy on Credit for Prior Learning, page 13.)

Academic Policies that Govern the Associate in Arts Elementary Education Degree

- Completion of the Associate in Arts or the AGECE-A provides for exemption from Arizona public university admission requirements for Arizona residents who have a minimum Grade Point Average of 2.0 on a 4.0=A scale and a minimum 2.5 on a 4.0=A scale for nonresidents.
- The graduation policies within the general catalog must be satisfied for completion of the Associate in Arts degree.
- A minimum of 60-63 semester credits in courses numbered 100 and above to be completed with a grade of C or better.
- The General Education Requirements for AGECE-A may be completed in 35 semester credits with the following stipulations:
 1. Courses can satisfy a Core Area Requirement and one or more Awareness Areas simultaneously.
 2. A course cannot be used to satisfy more than one Core Area.
 3. Courses can satisfy an Elementary Education Requirement and one or more Awareness Areas simultaneously.
 4. A course cannot satisfy both the Elementary Education Requirement and a Core Area Requirement simultaneously.
- Effective Fall 2000, the course evaluation and/or general education designation as listed in the Arizona Course Equivalency Guide (CEG) within the Arizona Course Applicability System (AZCAS) is valid for the term in which the student is awarded credit on the transcript. A course evaluation and/or general education designation may be subject to change. Students do have the option to petition for general education evaluations and/or general education designations upon transfer.
- Courses completed at one of the Maricopa Community Colleges to meet AGECE-A requirements must be listed in the Course Equivalency Guide within the Arizona Course Applicability System as an equivalent

course, departmental elective credit (XXXXDEC), or general elective credit (Elective) at all Arizona public universities. The course's evaluation and/or general education designation is valid for the term in which the student is awarded credit on the transcript. See the list titled MCCCD Courses That Can Be Used to Satisfy MCCCD AGECE-A, AGECE-B and/or AGECE-S, page 36, for specific course information. The most up-to-date information can be accessed via the following web address:

<http://www.maricopa.edu/academic/curric/>

Select tab labeled *Curriculum Procedures Handbook - Programs*

Select *Academic Programs*

Select *Matrix of MCCCD Courses* (AGECE Course Matrix)

- Courses completed at one of the Maricopa Community Colleges to meet the General Electives requirement must be listed in the Course Equivalency Guide (CEG) within the Arizona Course Applicability System (AZCAS) as an equivalent course, departmental elective credit (XXXXDEC), or general elective credit (Elective) at all Arizona public universities. For appropriate course selection, students should consult with an advisor.
- Courses transferred from another regionally accredited institution to one of the Maricopa Community Colleges will be evaluated by the college for inclusion in the AGECE-A or Associate in Arts Elementary Education Degree.
- Courses and their modular equivalents will satisfy AGECE-A and Associate in Arts Elementary Education requirements.
- If a course is cross-referenced with one or more other courses, then only one of the cross-referenced courses will be accepted to meet requirements.

Degree Requirements

Credits

I. MCCCD General Education Requirements 35-38

A. MCCCD AGECE-A (35)

I. Core Areas

- a. First-Year Composition (FYC)6
ENG101/ENG102 OR ENG107/ENG108
- b. Mathematical Studies [MA] AND
Computer/Statistics/Quantitative Applications [CS] ..6
 - 1) MAT142 [MA] College Mathematics or higher
(Note: MAT150, MAT151, MAT152, MAT156 and MAT157 are excluded.)AND
 - 2) CIS105 [CS] Survey of Computer Information Systems
OR
BPC110 [CS] Computer Usage and Applications
- c. Literacy and Critical Inquiry [L]3
 - 1) Select 3 semester credits from the following courses:
COM225 Public Speaking
OR
COM230 Small Group Communication
- d. Humanities and Fine Arts [HU]6
 - 1) Select 3 semester credits from the following courses:
ARH100 Introduction to Art
ARH101 Prehistoric through Gothic Art
ARH102 Renaissance through Contemporary Art
AND

Associate in Arts in Elementary Education (AAEE) Degree

- 2) Select 3 semester credits from the following courses:
ENH110 Introduction to Literature
ENH241 American Literature Before 1860
ENH242 American Literature After 1860
EDU/ENH291 Children's Literature
HUM250 OR HUM251 Ideas and Values in the Humanities
THE111 Introduction to Theatre
THE220 Modern Drama
DAH100 Introduction to Dance
DAH201 World Dance Perspectives
- e. **Social and Behavioral Sciences [SB]** 6
- 1) Select 3 semester credits from the following courses:
HIS103 United States History to 1870
HIS104 United States History 1870 to Present
AND
- 2) Select 3 semester credits from the following courses:
PSY101 Introduction to Psychology
GCU121 World Geography I: Eastern Hemisphere
GCU122 World Geography II: Western Hemisphere
ECN111 Macroeconomic Principles
ECN112 Microeconomic Principles
POS110 American National Government
ECH/CFS176 Child Development
- f. **Natural Sciences [SQ/SG]** 8
- To complete the Natural Sciences requirement, select a total of eight (8) semester credits from the following categories. At least four (4) credits must be SQ courses. You can select four (4) semester credits of SG and four (4) semester credits of SQ for a total of eight (8) semester credits. Natural Sciences courses must include or be accompanied by the corresponding laboratory course. When the lecture and corresponding laboratory are awarded separate credit, both will be counted as equivalent to one course in that discipline.
- Select SQ (Life Science) and SG (Physical Sciences, Earth/Space Sciences) courses from the following categories:
- 1) Life Sciences
AND
2) Physical Sciences OR Earth/Space Sciences

2. Awareness Areas

The MCCC AEE requires coursework in two Awareness Areas:

Cultural Diversity in the United States [C]

AND

Global Awareness [G]

OR

Historical Awareness [H]

Courses can satisfy a Core Area Requirement and one or more Awareness Areas, or can satisfy an Elementary Education Requirement and one or more Awareness Areas simultaneously. Therefore, no additional semester credits are required to satisfy the two Awareness Areas.

B. MCCC Additional Requirements (0-3)

I. Oral Communication

Satisfied by COM225 or COM230 taken for Literacy and Critical Inquiry Requirement

2. Critical Reading

CRE101 or exemption by testing

II. Elementary Education Requirements 25

A total of twenty-five (25) semester credits are required to satisfy the Elementary Education Requirements.

A. Education Foundations (15)

Complete the following courses to satisfy the Education Foundations requirements:

- EDU221 Introduction to Education
- EDU222 Introduction to the Exceptional Learner
- EDU230 Cultural Diversity in Education
- MAT156 Mathematics for Elementary Teachers I
- MAT157 Mathematics for Elementary Teachers II

B. Electives for Arizona Professional Teacher Standards (10)

A total of ten (10) semester credits are required to satisfy the Electives for Arizona Professional Teacher Standards: three (3) credits in an additional Education course and seven (7) credits in Content Area Electives.

Courses must transfer to all public Arizona universities as Elective Credit, Departmental Elective, or Equivalent to a university course as indicated in the Arizona Course Equivalency Guide (CEG) in effect when the course is taken. Courses identified as non-transferable in the Arizona Course Equivalency Guide cannot be used to satisfy this requirement.

I. Additional Education Course Requirement

Select any EDU course (except EDU221, EDU222, EDU230 and EDU250) to satisfy this requirement.

2. Content Area Electives

Select seven (7) credits from the following:

- Any ARH, ART, BPC, CIS, ENG, ENH, GPH, HIS, MHL, MTC, POS, THE, THP prefixed course(s)
- Any EDU prefixed course(s) (except EDU250)
- Any MAT (courses numbered higher than MAT142 except MAT150, MAT151, MAT152, MAT156 and MAT157)
- Any Foreign Language course(s)
- Any Natural Science course(s)
- CFS/ECH176 Child Development

AAEE Total Credits:

60-63

ASSOCIATE IN ARTS, FINE ARTS - DANCE (AAFA - DANCE) DEGREE

Description

The Maricopa County Community College District (MCCCD) Associate in Arts, Fine Arts - Dance (AAFA - Dance) degree requires a minimum of 64 semester credits for the program of study. The degree includes the following components: 1) General Education which includes Arizona General Education Curriculum for Arts (AGEC-A) and MCCCD Additional Requirements; and 2) Fine Arts Requirements - Dance.

Purpose of the Degree

The Associate in Arts, Fine Arts - Dance degree is designed for students planning to transfer to four-year colleges and universities. In general, the components of the degree meet requirements for majors in the Fine Arts. The degree is designed to prepare students to meet selective admission criteria for programs such as the Bachelor of Fine Arts, which may require a portfolio or performance requirement.

The semester credits used to satisfy the MCCCD Associate in Arts, Fine Arts - Dance degree will apply to university graduation requirements of the university major for which the degree is designed. Information regarding the articulation of the degree with majors at the Arizona public universities can be accessed via the following website:

<http://az.transfer.org/cas/atass/student/modpath.html>

Academic Policies that Govern the Associate in Arts, Fine Arts - Dance Degree

- Completion of the Associate in Arts, Fine Arts - Dance degree or the AGECA provides for exemption from Arizona public university admission requirements for Arizona residents who have a minimum Grade Point Average of 2.0 on a 4.0=A scale and a minimum 2.5 on a 4.0=A scale for nonresidents.
- The graduation policies within the general catalog must be satisfied for completion of the Associate in Arts, Fine Arts - Dance degree.
- A minimum of 60 semester credits in courses numbered 100 and above to be completed with a grade of C or better.
- The General Education Requirements for AGECA may be completed in 35 semester credits with the following stipulations:
 1. Courses can satisfy a Core Area and one or two Awareness Areas simultaneously.
 2. A course cannot be used to satisfy more than one Core Area.
- General Education courses can satisfy multiple areas within the degree simultaneously (AGECA Core Area, AGECA Awareness Area, MCCCD Additional Requirements, or lower-division courses applicable to the major).
- Effective Fall 2000, the course evaluation and/or general education designation as listed in the Arizona Course Equivalency Guide (CEG) within the Arizona Course Applicability System (AZCAS) is valid for the term in which the student is awarded credit on the transcript. A course evaluation and/or general education designation may be subject to change. Students do have the option to petition for general education evaluations and/or general education designations upon transfer.
- Courses completed at one of the Maricopa Community Colleges to meet AGECA requirements must be listed in the Course Equivalency Guide within the Arizona Course Applicability System as an equivalent course, departmental elective credit (XXXXDEC), or general elective credit (Elective) at all Arizona public universities. The course's evaluation and/or general education designation is valid for the term in which the student is awarded credit on the transcript. See the list titled MCCCD Courses That Can Be Used to Satisfy MCCCD AGECA, AGECA-B and/or AGECA-S, page 36 (2006-2007 catalog), for specific course information. The most up-to-date information can be accessed via the following web address:

<http://www.maricopa.edu/academic/curric/>
Select tab labeled *Curriculum Procedures Handbook - Programs*
Select *Academic Programs*
Select *Matrix of MCCCD Courses* (AGECA Course Matrix)

- Courses completed at one of the Maricopa Community Colleges to meet the General Electives requirement must be listed in the Course Equivalency Guide (CEG) within the Arizona Course Applicability System (AZCAS) as an equivalent course, departmental elective credit (XXXXDEC), or general elective credit (Elective) at all Arizona public universities. For appropriate course selection, students should consult with an advisor.
- Courses transferred from another regionally accredited institution to one of the Maricopa Community Colleges will be evaluated by the college for inclusion in the AGECA or Associate in Arts, Fine Arts - Dance Degree.
- Courses and their modular equivalents will satisfy AGECA and Associate in Arts, Fine Arts - Dance requirements.
- If a course is cross-referenced with one or more other courses, then only one of the cross-referenced courses will be accepted to meet requirements.

Degree Requirements

The 64 semester credits required for the Associate in Arts, Fine Arts - Dance degree follow. See the list titled MCCCD Courses That Can Be Used to Satisfy MCCCD AGECA, AGECA-B and/or AGECA-S, page 36 (2006-2007 catalog), for specific course information. The most up-to-date information can be accessed via the following web address:

<http://www.maricopa.edu/academic/curric/>
Select tab labeled *Curriculum Procedures Handbook - Programs*
Select *Academic Programs*
Select *Matrix of MCCCD Courses* (AGECA Course Matrix)

This list identifies the courses in alpha-order by prefix as well as the Core Areas and Awareness Areas where the course will apply. For purposes of clarifying requirements in the Mathematics and Natural Sciences areas on the list and the AGECA requirements, an A, B and/or S character may follow the [MA], [SQ], [SG] general education designations and refers to the specific AGECA.

I. MCCCD General Education

The MCCCD General Education includes two areas:
MCCCD AGECA and MCCCD Additional Requirements.

A. MCCCD AGECA

Credits

I. Core Areas: Credits 35

- a. First-Year Composition (FYC) 6
- b. Literacy and Critical Inquiry [L] 3
- c. Mathematical Studies [MA/CS] 6
To complete the Mathematical Studies requirement, select one course to satisfy the Mathematics [MA] A and a second course from Computer/Statistics/Quantitative Applications [CS].
 - 1) Mathematics [MA] A (3 credits)
Select a course in college mathematics or college algebra or precalculus or any other mathematics course for which college algebra is a prerequisite.
AND
 - 2) Computer/Statistics/Quantitative Applications [CS] (3 credits)
- d. Humanities and Fine Arts [HU] 6
Students are encouraged to choose course work from more than one discipline for a total of six (6) semester credits.
Select from the following options to complete three credits:
DAH100 Introduction to Dance 3
DAH201 World Dance Perspectives 3

Associate in Arts, Fine Arts - Dance (AAFA - Dance) Degree

- e. Social and Behavioral Sciences [SB] 6
Students are encouraged to choose course work from more than one discipline for a total of six (6) semester credits.
- f. Natural Sciences [SQ/SG] 8
To complete the Natural Sciences requirement:
Select four (4) semester credits of [SQ] and four (4) semester credits of [SG] for a total of eight (8) semester credits, **OR** eight (8) semester credits of [SQ]. Students **cannot** take eight (8) semester credits of [SG] to meet the Natural Sciences requirement.

The lecture course(s) selected for Natural Sciences must include or be accompanied by the corresponding laboratory course. The lecture and corresponding laboratory course(s) may carry separate credit. Students should consult with an advisor for appropriate course selection. Students should also access the Arizona Course Equivalency Guide (CEG) within the Arizona Course Applicability System (AZCAS) for information on equivalencies.

Select from the following options to complete four credits:
BIO160 Introduction to Human Anatomy/Physiology ... 4
BIO201 Human Anatomy and Physiology I 4

2. Awareness Areas: Credits 0

Students must satisfy two Awareness Areas: Cultural Diversity in the United States [C] and either Global Awareness [G] or Historical Awareness [H]. However, it is not necessary for students to exceed thirty-five (35) semester credits to complete the Awareness Areas because courses can satisfy a Core Area and one or two Awareness Areas simultaneously. Therefore, no additional semester credits are required to satisfy the two Awareness Areas.

Cultural Diversity in the United States [C] **AND**
Global Awareness [G] **OR** Historical Awareness [H]

B. MCCC Additional Requirements Credits: 0-6

Students must satisfy Oral Communication and Critical Reading areas. However, it is not necessary for students to exceed the thirty-five (35) semester credits required in order to complete the MCCC Additional Requirements because courses can satisfy a Core Area and MCCC Additional Requirements simultaneously. Therefore, no additional semester credits are required to satisfy Oral Communication and Critical Reading.

1. Oral Communication: Credits 3

A total of three (3) semester credits is required for Oral Communication. However, if students select a communication course that satisfies both the Oral Communication area and an area within the Core, then the Oral Communication requirement has been satisfied and additional electives may be taken.

Select from the following options:

- COM100 [SB] (3 credits) **OR**
- COM100AA & COM100AB & COM100AC [SB] (3 credits) **OR**
- COM110 [SB] (3 credits) **OR**
- COM110AA & COM110AB & COM110AC [SB] (3 credits) **OR**
- COM225 [L] (3 credits) **OR**
- COM230 [L] [SB] (3 credits)

2. Critical Reading: Credits 3

A total of three (3) semester credits is required for the Critical Reading area. However, if students complete CRE101 and apply it to AGEC-A Core Requirements or if students demonstrate proficiency through assessment, then the Critical Reading requirement has been satisfied and additional electives may be taken.

Select from the following options to complete three credits:
CRE101 [L] (3 credits) **OR**
equivalent as indicated by assessment

II. Fine Arts Requirements - Dance: Credits 29

A minimum of 29 credits are required to satisfy the Fine Arts Requirements - Dance.

Part I: Credits 11

Select the following:

DAN150	Dance Performance I	1
DAN210	Dance Production I	3
DAN221	Rhythmic Theory for Dance I	2
DAN264	Choreography I	3
DAN280	Dance Practicum	2

Part II: Credits 9

Select from the following options to complete a minimum of nine-semester credits. Students must attain Level III competency in ballet and modern dance courses:

DAN120++	World Dance (any module)	1
DAN129	Musical Theatre Dance I	1
DAN130	Musical Theatre Dance II	1
DAN131	Ballet I	1
DAN132	Modern Dance I	1
DAN133	Modern Jazz Dance I	1
DAN134	Ballet II	1
DAN135	Modern Dance II	1
DAN136	Modern Jazz Dance II	1
DAN229	Musical Theatre Dance III	1
DAN230	Musical Theatre Dance IV	1
DAN231	Ballet III	1
DAN231AA	Ballet III: Intensive	2
DAN232	Modern Dance III	1
DAN233	Modern Jazz Dance III	1
DAN234	Ballet IV	1
DAN234AA	Ballet IV: Intensive	2
DAN235	Modern Dance IV	1
DAN236	Modern Jazz Dance IV	1
DAN237	Ballet Pointe I	1
DAN290++	Dance Conservatory I (any module)	1-3
DAN291++	Dance Conservatory II (any module)	1-3
DAN292++	Dance Conservatory III (any module)	1-3

Part III: Restricted Electives: Credits 9

The remaining credits from DAH and DAN prefixed courses should be selected as prescribed by the dance advisor. Only three of the remaining credits may be selected from the following DAN prefixed courses:

DAH++++ Any DAH prefixed course EXCEPT DAH100 or
DAH201 is selected to satisfy the AGEC A
Humanities and Fine Arts Area.

DAN115++	Contemporary Dance Trends (any module)	1
DAN120++	World Dance (any module)	1
DAN125++	Social Dance (any module)	1
DAN129	Musical Theatre Dance I	1
DAN130	Musical Theatre Dance II	1
DAN133	Modern Jazz Dance I	1
DAN136	Modern Jazz Dance II	1
DAN140	Tap Dance I	1
DAN141	Dance Workshop	1
DAN150	Dance Performance I	1
DAN164	Improvisation	1
DAN230	Musical Theatre Dance IV	1
DAN231	Ballet III	1
DAN231AA	Ballet III: Intensive	2
DAN232	Modern Dance III	1
DAN233	Modern Jazz Dance III	1
DAN234	Ballet IV	1
DAN234AA	Ballet IV: Intensive	2
DAN235	Modern Dance IV	1
DAN236	Modern Jazz Dance IV	1
DAN237	Ballet Pointe I	1
DAN290++	Dance Conservatory I (any module)	1-3
DAN291++	Dance Conservatory II (any module)	1-3
DAN292++	Dance Conservatory III (any module)	1-3
DAN298++	Special Projects (any module)	1-3

Associate in Arts, Fine Arts - Dance Total Credits:

64

ASSOCIATE IN ARTS, FINE ARTS - ART (AAFA - ART) DEGREE

Description

The Maricopa County Community College District (MCCCD) Associate in Arts, Fine Arts - Art (AAFA - Art) degree requires a minimum of 63 semester credits for the program of study. The degree includes the following components: 1) General Education which includes Arizona General Education Curriculum for Arts (AGEC-A) and MCCCD Additional Requirements; and 2) Fine Arts Requirements - Art.

Purpose of the Degree

The Associate in Arts, Fine Arts - Art degree is designed for students planning to transfer to four-year colleges and universities. In general, the components of the degree meet requirements for majors in the Fine Arts. The degree is designed to prepare students to meet selective admission criteria for programs such as the Bachelor of Fine Arts, which may require a portfolio or performance requirement.

The semester credits used to satisfy the MCCCD Associate in Arts, Fine Arts - Art degree will apply to university graduation requirements of the university major for which the degree is designed. Information regarding the articulation of the degree with majors at the Arizona public universities can be accessed via the following website:

<http://az.transfer.org/cas/atass/student/modpath.html>

Academic Policies that Govern the Associate in Arts, Fine Arts - Art Degree

- Completion of the Associate in Arts, Fine Arts - Art degree or the AGECA provides for exemption from Arizona public university admission requirements for Arizona residents who have a minimum Grade Point Average of 2.0 on a 4.0=A scale and a minimum 2.5 on a 4.0=A scale for nonresidents.
- The graduation policies within the general catalog must be satisfied for completion of the Associate in Arts, Fine Arts - Art degree.
- A minimum of 60 semester credits in courses numbered 100 and above to be completed with a grade of C or better.
- The General Education Requirements for AGECA may be completed in 35 semester credits with the following stipulations:
 1. Courses can satisfy a Core Area and one or two Awareness Areas simultaneously.
 2. A course cannot be used to satisfy more than one Core Area.
- General Education courses can satisfy multiple areas within the degree simultaneously (AGECA Core Area, AGECA Awareness Area, MCCCD Additional Requirements, or lower-division courses applicable to the major).
- Effective Fall 2000, the course evaluation and/or general education designation as listed in the Arizona Course Equivalency Guide (CEG) within the Arizona Course Applicability System (AZCAS) is valid for the term in which the student is awarded credit on the transcript. A course evaluation and/or general education designation may be subject to change. Students do have the option to petition for general education evaluations and/or general education designations upon transfer.
- Courses completed at one of the Maricopa Community Colleges to meet AGECA requirements must be listed in the Course Equivalency Guide within the Arizona Course Applicability System as an equivalent course, departmental elective credit (XXXXDEC), or general elective credit (Elective) at all Arizona public universities. The course's evaluation and/or general education designation is valid for the term in which the student is awarded credit on the transcript. See the list

titled MCCCD Courses That Can Be Used to Satisfy MCCCD AGECA, AGECA-B and/or AGECA-S, page 36 (2006-2007 catalog), for specific course information. The most up-to-date information can be accessed via the following web address:

<http://www.maricopa.edu/academic/curric/>

Select tab labeled *Curriculum Procedures Handbook - Programs*
Select *Academic Programs*

Select *Matrix of MCCCD Courses* (AGECA Course Matrix)

- Courses completed at one of the Maricopa Community Colleges to meet the General Electives requirement must be listed in the Course Equivalency Guide (CEG) within the Arizona Course Applicability System (AZCAS) as an equivalent course, departmental elective credit (XXXXDEC), or general elective credit (Elective) at all Arizona public universities. For appropriate course selection, students should consult with an advisor.
- Courses transferred from another regionally accredited institution to one of the Maricopa Community Colleges will be evaluated by the college for inclusion in the AGECA or Associate in Arts, Fine Arts - Associate in Arts, Fine Arts - Art (AAFA - Art) Degree Degree.
- Courses and their modular equivalents will satisfy AGECA and Associate in Arts, Fine Arts - Art requirements.
- If a course is cross-referenced with one or more other courses, then only one of the cross-referenced courses will be accepted to meet requirements.

Degree Requirements

The 63 semester credits required for the Associate in Arts, Fine Arts - Art degree follow. See the list titled MCCCD Courses That Can Be Used to Satisfy MCCCD AGECA, AGECA-B and/or AGECA-S, page 36 (2006-2007 catalog), for specific course information. The most up-to-date information can be accessed via the following web address:

<http://www.maricopa.edu/academic/curric/>

Select tab labeled *Curriculum Procedures Handbook - Programs*
Select *Academic Programs*

Select *Matrix of MCCCD Courses* (AGECA Course Matrix)

This list identifies the courses in alpha-order by prefix as well as the Core Areas and Awareness Areas where the course will apply. For purposes of clarifying requirements in the Mathematics and Natural Sciences areas on the list and the AGECA requirements, an A, B and/or S character may follow the [MA], [SQ], [SG] general education designations and refers to the specific AGECA.

I. MCCCD General Education

The MCCCD General Education includes two areas:
MCCCD AGECA and MCCCD Additional Requirements.

A. MCCCD AGECA

Credits

I. Core Areas: Credits 35

- a. First-Year Composition (FYC) 6
 - b. Literacy and Critical Inquiry [L] 3
 - c. Mathematical Studies [MA/CS] 6
- To complete the Mathematical Studies requirement, select one course to satisfy the Mathematics [MA] A and a second course from Computer/Statistics/Quantitative Applications [CS].
- 1) Mathematics [MA] A (3 credits)
Select a course in college mathematics or college algebra or precalculus or any other mathematics course for which college algebra is a prerequisite.
AND
 - 2) Computer/Statistics/Quantitative Applications [CS] (3 credits)

Associate in Arts, Fine Arts - Art (AAFA - Art) Degree

- d. Humanities and Fine Arts [HU] 6
Students are encouraged to choose course work from more than one discipline for a total of six (6) semester credits.
Select the following:
ARH101 Prehistoric Through Gothic Art (3 credits)
- e. Social and Behavioral Sciences [SB] 6
Students are encouraged to choose course work from more than one discipline for a total of six (6) semester credits.
- f. Natural Sciences [SQ/SG] 8
To complete the Natural Sciences requirement:
Select four (4) semester credits of [SQ] and four (4) semester credits of [SG] for a total of eight (8) semester credits, OR eight (8) semester credits of [SQ]. Students **cannot** take eight (8) semester credits of [SG] to meet the Natural Sciences requirement.

The lecture course(s) selected for Natural Sciences must include or be accompanied by the corresponding laboratory course. The lecture and corresponding laboratory course(s) may carry separate credit. Students should consult with an advisor for appropriate course selection. Students should also access the Arizona Course Equivalency Guide (CEG) within the Arizona Course Applicability System (AZCAS) for information on equivalencies.

2. Awareness Areas: Credits 0

Students must satisfy two Awareness Areas: Cultural Diversity in the United States [C] and either Global Awareness [G] or Historical Awareness [H]. However, it is not necessary for students to exceed thirty-five (35) semester credits to complete the Awareness Areas because courses can satisfy a Core Area and one or two Awareness Areas simultaneously. Therefore, no additional semester credits are required to satisfy the two Awareness Areas.

Cultural Diversity in the United States [C] AND
Global Awareness [G] OR
Historical Awareness [H]

B. MCCC Additional Requirements Credits: 0-6

Students must satisfy Oral Communication and Critical Reading areas. However, it is not necessary for students to exceed the thirty-five (35) semester credits required in order to complete the MCCC Additional Requirements because courses can satisfy a Core Area and MCCC Additional Requirements simultaneously. Therefore, no additional semester credits are required to satisfy Oral Communication and Critical Reading.

I. Oral Communication: Credits 3

A total of three (3) semester credits is required for Oral Communication. However, if students select a communication course that satisfies both the Oral Communication area and an area within the Core, then the Oral Communication requirement has been satisfied and additional electives may be taken.

Select from the following options:

- COM100 [SB] (3 credits) OR
- COM100AA & COM100AB & COM100AC [SB] (3 credits) OR
- COM110 [SB] (3 credits) OR
- COM110AA & COM110AB & COM110AC [SB] (3 credits) OR
- COM225 [L] (3 credits) OR
- COM230 [L] [SB] (3 credits)

2. Critical Reading: Credits 3

A total of three (3) semester credits is required for the Critical Reading area. However, if students complete CRE101 and apply it to AGEC-A Core Requirements or if students demonstrate proficiency through assessment, then the Critical Reading requirement has been satisfied and additional electives may be taken.

Select from the following options to complete three credits:
CRE101 [L] (3 credits) OR
equivalent as indicated by assessment

II. Fine Arts Requirements - Art: Credits 28

A minimum of 28 credits are required to satisfy the Fine Arts Requirements - Art.

Foundations: Credits 16

Select the following:

ADA/ART112	Two-Dimensional Design	3
ADA/ART115	Three-Dimensional Design	3
ARH102	Renaissance Through Contemporary Art	3
ART111	Drawing I	3
ART113	Color	3
ART255AB	The Portfolio	1

Restricted Electives: Credits 12

Select from the following options to complete a minimum of twelve-semester credits:

ART116	Life Drawing I	3
ART122	Drawing and Composition II	3
ART131	Photography I	3
ART132	Photography II	3
ART151	Sculpture I	3
ART161	Ceramics I	3
ART165	Watercolor Painting I	3
ART167	Painting I	3

Associate in Arts, Fine Arts - Art Total Credits: 63

ASSOCIATE IN ARTS, FINE ARTS - THEATRE (AAFA - THEATRE) DEGREE

Description

The Maricopa County Community College District (MCCCD) Associate in Arts, Fine Arts - Theatre (AAFA - Theatre) degree requires a minimum of 60-64 semester credits for the program of study. The degree includes the following components: 1) General Education which includes Arizona General Education Curriculum for Arts (AGEC-A) and MCCCD Additional Requirements; and 2) Fine Arts Requirements - Theatre.

Purpose of the Degree

The Associate in Arts, Fine Arts - Theatre degree is designed for students planning to transfer to four-year colleges and universities. In general, the components of the degree meet requirements for majors in the Fine Arts. The degree is designed to prepare students to meet selective admission criteria for programs such as the Bachelor of Fine Arts, which may require a portfolio or performance requirement.

The semester credits used to satisfy the MCCCD Associate in Arts, Fine Arts - Theatre degree will apply to university graduation requirements of the university major for which the degree is designed. Information regarding the articulation of the degree with majors at the Arizona public universities can be accessed via the following website:

<http://az.transfer.org/cas/atass/student/modpath.html>

Academic Policies that Govern the Associate in Arts, Fine Arts - Theatre Degree

- Completion of the Associate in Arts, Fine Arts - Theatre degree or the AGECA provides for exemption from Arizona public university admission requirements for Arizona residents who have a minimum Grade Point Average of 2.0 on a 4.0=A scale and a minimum 2.5 on a 4.0=A scale for nonresidents.
- The graduation policies within the general catalog must be satisfied for completion of the Associate in Arts, Fine Arts - Theatre degree.
- A minimum of 60 semester credits in courses numbered 100 and above to be completed with a grade of C or better.
- The General Education Requirements for AGECA may be completed in 35 semester credits with the following stipulations:
 1. Courses can satisfy a Core Area and one or two Awareness Areas simultaneously.
 2. A course cannot be used to satisfy more than one Core Area.
- General Education courses can satisfy multiple areas within the degree simultaneously (AGECA Core Area, AGECA Awareness Area, MCCCD Additional Requirements, or lower-division courses applicable to the major).
- Effective Fall 2000, the course evaluation and/or general education designation as listed in the Arizona Course Equivalency Guide (CEG) within the Arizona Course Applicability System (AZCAS) is valid for the **term** in which the student is awarded credit on the transcript. A course evaluation and/or general education designation may be subject to change. Students do have the option to petition for general education evaluations and/or general education designations upon transfer.
- Courses completed at one of the Maricopa Community Colleges to meet AGECA requirements must be listed in the Course Equivalency Guide within the Arizona Course Applicability System as an equivalent course, departmental elective credit (XXXXDEC), or general elective credit (Elective) at all Arizona public universities. The course's evaluation and/or general education designation is valid for the term in which the student is awarded credit on the transcript. See the list titled MCCCD Courses That Can Be Used to Satisfy MCCCD AGECA, AGECA-B and/or AGECA-S, page 36 (2006-2007 catalog), for

specific course information. The most up-to-date information can be accessed via the following web address:

<http://www.maricopa.edu/academic/curric/>

Select tab labeled *Curriculum Procedures Handbook - Programs*

Select *Academic Programs*

Select *Matrix of MCCCD Courses* (AGEC Course Matrix)

- Courses completed at one of the Maricopa Community Colleges to meet the General Electives requirement must be listed in the Course Equivalency Guide (CEG) within the Arizona Course Applicability System (AZCAS) as an equivalent course, departmental elective credit (XXXXDEC), or general elective credit (Elective) at all Arizona public universities. For appropriate course selection, students should consult with an advisor.
- Courses transferred from another regionally accredited institution to one of the Maricopa Community Colleges will be evaluated by the college for inclusion in the AGECA or Associate in Arts, Fine Arts - Theatre Degree.
- Courses and their modular equivalents will satisfy AGECA and Associate in Arts, Fine Arts - Theatre requirements.
- If a course is cross-referenced with one or more other courses, then only one of the cross-referenced courses will be accepted to meet requirements.

Degree Requirements

The 60-64 semester credits required for the Associate in Arts, Fine Arts - Theatre degree follow. See the list titled MCCCD Courses That Can Be Used to Satisfy MCCCD AGECA, AGECA-B and/or AGECA-S, page 36 (2006-2007 catalog), for specific course information. The most up-to-date information can be accessed via the following web address:

<http://www.maricopa.edu/academic/curric/>

Select tab labeled *Curriculum Procedures Handbook - Programs*

Select *Academic Programs*

Select *Matrix of MCCCD Courses* (AGEC Course Matrix)

This list identifies the courses in alpha-order by prefix as well as the Core Areas and Awareness Areas where the course will apply. For purposes of clarifying requirements in the Mathematics and Natural Sciences areas on the list and the AGECA requirements, an A, B and/or S character may follow the [MA], [SQ], [SG] general education designations and refers to the specific AGECA.

I. MCCCD General Education

The MCCCD General Education includes two areas: MCCCD AGECA and MCCCD Additional Requirements.

A. MCCCD AGECA

Credits

I. Core Areas: Credits 35

- a. First-Year Composition (FYC) 6
- b. Literacy and Critical Inquiry [L] 3

Select the following:

THE220 Modern Drama (3 credits)

- c. Mathematical Studies [MA/CS] 6

To complete the Mathematical Studies requirement, select one course to satisfy the Mathematics [MA] A and a second course from Computer/Statistics/Quantitative Applications [CS].

- 1) Mathematics [MA] A (3 credits)

Select a course in college mathematics or college algebra or precalculus or any other mathematics course for which college algebra is a prerequisite.

AND

- 2) Computer/Statistics/Quantitative Applications [CS] (3 credits)

Associate in Arts, Fine Arts - Theatre (AAFA - Theatre) Degree

- d. Humanities and Fine Arts [HU] 6
Students are encouraged to choose course work from more than one discipline for a total of six (6) semester credits.
Select the following:
THE205 Introduction to Cinema (3 credits)
- e. Social and Behavioral Sciences [SB] 6
Students are encouraged to choose course work from more than one discipline for a total of six (6) semester credits.
- f. Natural Sciences [SQ/SG] 8
To complete the Natural Sciences requirement:
Select four (4) semester credits of [SQ] and four (4) semester credits of [SG] for a total of eight (8) semester credits, **OR** eight (8) semester credits of [SQ]. Students **cannot** take eight (8) semester credits of [SG] to meet the Natural Sciences requirement.

The lecture course(s) selected for Natural Sciences must include or be accompanied by the corresponding laboratory course. The lecture and corresponding laboratory course(s) may carry separate credit. Students should consult with an advisor for appropriate course selection. Students should also access the Arizona Course Equivalency Guide (CEG) within the Arizona Course Applicability System (AZCAS) for information on equivalencies.

2. Awareness Areas: Credits 0

Students must satisfy two Awareness Areas: Cultural Diversity in the United States [C] and either Global Awareness [G] or Historical Awareness [H]. However, it is not necessary for students to exceed thirty-five (35) semester credits to complete the Awareness Areas because courses can satisfy a Core Area and one or two Awareness Areas simultaneously. Therefore, no additional semester credits are required to satisfy the two Awareness Areas.

Cultural Diversity in the United States [C] **AND**
Global Awareness [G] **OR**
Historical Awareness [H]

B. MCCC Additional Requirements Credits: 0-6

Students must satisfy Oral Communication and Critical Reading areas. However, it is not necessary for students to exceed the thirty-five (35) semester credits required in order to complete the MCCC Additional Requirements because courses can satisfy a Core Area and MCCC Additional Requirements simultaneously. Therefore, no additional semester credits are required to satisfy Oral Communication and Critical Reading.

I. Oral Communication: Credits 3

A total of three (3) semester credits is required for Oral Communication. However, if students select a communication course that satisfies both the Oral Communication area and an area within the Core, then the Oral Communication requirement has been satisfied and additional electives may be taken.

Select from the following options:

COM100 [SB] (3 credits) **OR**
COM100AA & COM100AB & COM100AC [SB] (3 credits) **OR**
COM110 [SB] (3 credits) **OR**
COM110AA & COM110AB & COM110AC [SB] (3 credits) **OR**
COM225 [L] (3 credits) **OR**
COM230 [L] [SB] (3 credits)

2. Critical Reading: Credits 3

A total of three (3) semester credits is required for the Critical Reading area. However, if students complete CRE101 and apply it to AGEC-A Core Requirements or if students demonstrate proficiency through assessment, then the Critical Reading requirement has been satisfied and additional electives may be taken.

Select from the following options to complete three credits:
CRE101 [L] (3 credits) **OR**
equivalent as indicated by assessment

II. Fine Arts Requirements - Theatre: Credits 25-29

A minimum of 25 credits are required to satisfy the Fine Arts Requirements - Theatre.

Foundations: Credits 13

Select the following:

THE111	Introduction to Theatre	3
THP112	Acting I	3
THP115	Theatre Makeup	3
THP201	Theatre Production I	1
THP213	Introduction to Technical Theatre	3

Restricted Electives: Credits 12-16

Students may choose from the following courses to specialize in Acting, Technical Theatre, Teacher Education, or Cinema. Students should consult with the theatre advisor for the restricted electives recommended for each specialization track.

Select from the following options to complete a minimum of twelve-semester credits:

HUM/THE206	Introduction to Television Arts	3
HUM/THE210	Contemporary Cinema	3
THP120AB	Audition Techniques: Cold Readings	1
THP130	Stage Combat (3) OR	
THP131	Stage Movement	3
THP210	Acting: TV/Film	3
THP211	Creative Drama	3
THP212	Acting II	3
THP214	Directing Techniques	3
THP216	Beginning Stage Lighting	3
THP217	Introduction to Design Scenography	3
THP219	Introduction to Puppetry	3
THP267	Painting Techniques for Film, TV and Theatre	3
THP271	Voice and Diction	3

Associate in Arts, Fine Arts - Theatre Total Credits: 60-64

ASSOCIATE IN SCIENCE (AS) DEGREE

Description

The Maricopa County Community College District (MCCCD) Associate in Science degree (AS) requires 60-64 semester credits for the program of study. The degree includes the following components: 1) General Education which includes the Arizona General Education Curriculum for Science (AGEC-S) and MCCCD Additional Requirements; and 2) General Electives.

Purpose of the Degree

The Associate in Science degree is designed for students planning to transfer to four-year colleges and universities. In general, the components of the degree meet requirements for majors with more stringent mathematics and mathematics-based science requirements. The degree will transfer as a block without loss of credit to Arizona's public universities and other institutions with district-wide articulation agreements.

The semester credits used to satisfy the MCCCD Associate in Science will apply to university graduation requirements of the university major for which the Associate in Science is designed. Information regarding the articulation of the Associate in Science with majors at the Arizona public universities can be accessed via the following website:

<http://az.transfer.org/cas/atass/student/modpath.html>

Academic Policies that Govern the Associate in Science Degree

- Completion of the Associate in Science or the AGEC-S provides for exemption from Arizona public university admission requirements for Arizona residents who have a minimum Grade Point Average of 2.0 on a 4.0=A scale and a minimum 2.5 on a 4.0=A scale for nonresidents.
- The graduation policies within the general catalog must be satisfied for completion of the Associate in Science degree.
- A minimum of 60 semester credits in courses numbered 100 and above to be completed with a grade of C or better.
- The General Education Requirements for AGEC-S may be completed in 35 semester credits with the following stipulations:
 1. Courses can satisfy a Core Area and one or two Awareness Areas simultaneously.
 2. A course cannot be used to satisfy more than one Core Area.
- General Education courses can satisfy multiple areas within the degree simultaneously (AGEC-S Core Area, AGEC Awareness Area, MCCCD Additional Requirements, or lower-division courses applicable to the major).
- Effective Fall 2000, the course evaluation and/or general education designation as listed in the Arizona Course Equivalency Guide (CEG) within the Arizona Course Applicability System (AZCAS) is valid for the **term** in which the student is awarded credit on the transcript. A course evaluation and/or general education designation may be subject to change. Students do have the option to petition for general education evaluations and/or general education designations upon transfer.
- Courses completed at one of the Maricopa Community Colleges to meet AGEC-S requirements must be listed in the Course Equivalency Guide within the Arizona Course Applicability System as an equivalent course, departmental elective credit (XXXXDEC), or general elective credit (Elective) at all Arizona public universities. The course's evaluation and/or general education designation is valid for the term in which the student is awarded credit on the transcript. See the list titled [MCCCD Courses That Can Be Used to Satisfy MCCCD AGEC-A, AGEC-B and/or AGEC-S](#), page 36, for specific course information.

The most up-to-date information can be accessed via the following web address:

<http://www.maricopa.edu/academic/curric/>

Select tab labeled *Curriculum Procedures Handbook - Programs*

Select *Academic Programs*

Select *Matrix of MCCCD Courses* (AGEC Course Matrix)

- Courses completed at one of the Maricopa Community Colleges to meet the General Electives requirement must be listed in the Course Equivalency Guide (CEG) within the Arizona Course Applicability System (AZCAS) as an equivalent course, departmental elective credit (XXXXDEC), or general elective credit (Elective) at all Arizona public universities. For appropriate course selection, students should consult with an advisor.
- Courses transferred from another regionally accredited institution to one of the Maricopa Community Colleges will be evaluated by the college for inclusion in the AGEC-S or Associate in Science Degree.
- Courses and their modular equivalents will satisfy AGEC-S and Associate in Science requirements.
- If a course is cross-referenced with one or more other courses, then only one of the cross-referenced courses will be accepted to meet requirements.

Degree Requirements

The 60-64 semester credits required for the Associate in Science follow. See the list titled [MCCCD Courses That Can Be Used to Satisfy MCCCD AGEC-A, AGEC-B and/or AGEC-S](#), page 36, for specific course information. The most up-to-date information can be accessed via the following web address:

<http://www.maricopa.edu/academic/curric/>

Select tab labeled *Curriculum Procedures Handbook - Programs*

Select *Academic Programs*

Select *Matrix of MCCCD Courses* (AGEC Course Matrix)

This list identifies the courses in alpha-order by prefix as well as the Core Areas and Awareness Areas where the course will apply. For purposes of clarifying requirements in the Mathematics and Natural Sciences areas on the list and the AGEC requirements, an A, B and/or S character may follow the [MA], [SQ], [SG] general education designations and refers to the specific AGEC.

I. MCCCD General Education

Credits

The MCCCD General Education includes two areas:
MCCCD AGEC-S and MCCCD Additional Requirements.

A. MCCCD AGEC-S

35

I. Core Areas

- a. First-Year Composition (FYC) 6
 - b. Literacy and Critical Inquiry [L] 3
 - c. Mathematical Studies [MA/CS] 6
- To complete the Mathematical Studies requirement, select one course to satisfy the Mathematics [MA] S and a second course from Computer/Statistics/Quantitative Applications [CS].
- 1) Mathematics [MA] S (3 credits)
Select a calculus course, MAT220 or MAT221, or any mathematics course for which MAT220 or MAT221 is a prerequisite.
AND
 - 2) Computer/Statistics/Quantitative Applications [CS] (3 credits)

Associate in Science (AS) Degree

- d. Humanities and Fine Arts [HU] 6
Students are encouraged to choose course work from more than one discipline for a total of six (6) semester credits.
- e. Social and Behavioral Sciences [SB] 6
Students are encouraged to choose course work from more than one discipline for a total of six (6) semester credits.
- f. Natural Sciences [SQ/SG] 8
To complete the Natural Sciences requirement:
Select eight (8) semester credits of either general chemistry CHM151 & CHM151LL, and CHM152 & CHM152LL
OR
Eight (8) semester credits of university physics PHY115 & PHY116, OR PHY121 & PHY131
OR
Eight (8) semester credits of general biology, BIO181 & BIO182
appropriate to the major.

2. Awareness Areas

Students must satisfy two Awareness Areas: Cultural Diversity in the United States [C] and either Global Awareness [G] or Historical Awareness [H]. However, it is not necessary for students to exceed thirty-five (35) semester credits to complete the Awareness Areas because courses can satisfy a Core Area and one or two Awareness Areas simultaneously. Therefore, no additional semester credits are required to satisfy the two Awareness Areas.

Cultural Diversity in the United States [C]

AND

Global Awareness [G]

OR

Historical Awareness [H]

B. MCCCDC Additional Requirements 0-6

Students must satisfy Oral Communication and Critical Reading areas. However, it is not necessary for students to exceed the thirty-five (35) semester credits required in order to complete the MCCCDC Additional Requirements because courses can satisfy a Core Area and MCCCDC Additional Requirements simultaneously. Therefore, no additional semester credits are required to satisfy Oral Communication and Critical Reading.

I. Oral Communication

A total of three (3) semester credits is required for Oral Communication. However, if students select a communication course that satisfies both the Oral Communication area and an area within the Core, then the Oral Communication requirement has been satisfied and additional electives may be taken.

Select from the following options:

COM100 [SB] (3 credits) OR

COM100AA & COM100AB & COM100AC [SB] (3 credits)

OR

COM110 [SB] (3 credits) OR

COM110AA & COM110AB & COM110AC [SB] (3 credits)

OR

COM225 [L] (3 credits) OR

COM230 [L] [SB] (3 credits)

2. Critical Reading

A total of three (3) semester credits is required for the Critical Reading area. However, if students complete CRE101 and apply it to AGEC-S Core Requirements or if students demonstrate proficiency through assessment; then the Critical Reading requirement has been satisfied and additional electives may be taken.

CRE101 [L] OR equivalent as indicated by assessment

II. General Electives

Select courses to complete a minimum of 60 semester credits but no more than a total of 64 semester credits.

For students who have decided on a major that articulates with the AS, but who are undecided on the university to which they will transfer, courses satisfying the General Electives area should be selected from the list of Common Courses, Arizona Transfer Pathway Guides, and/or University Transfer Guides in order for the courses to apply in the major upon transfer.

The list of Common Courses for each major is included in the Arizona Transfer Pathway Guides. University Transfer Guides are also available for the Arizona public universities. These guides, both statewide and institutional, are accessible on the following website:

http://az.transfer.org/cas/students/transfer_guides.htm

Students must select MCCCDC courses that are acceptable as an equivalent course, departmental elective credit (XXXXDEC), or general elective credit (Elective) at all Arizona public universities according to the Arizona Course Equivalency Guide (CEG) within the Arizona Course Applicability System (AZCAS) (see web address below). For appropriate course selection, students should consult with an advisor.

<http://az.transfer.org/cas/atass/index.html>

Select *Student Information* followed by:

Course Applicability System (CAS)

Course Equivalency Guide (CEG)

Maricopa Community College District

For some majors, students must demonstrate 4th semester proficiency at the 202 course level to satisfy the Non-English Language Requirements. Students should consult the Arizona Transfer Pathway Guides and/or the University Transfer Guides to determine this requirement for the major at the university to which they intend to transfer. If required, it is recommended that students choose Maricopa courses as electives to meet this requirement as part of the Associate in Science degree.

Students who are undecided on a major or university should consult an advisor. Not all majors have common courses, so it is recommended that students consult with an advisor for a list of common courses or assistance with selecting appropriate electives.

Associate in Science Total Credits: 60-64

ASSOCIATE IN BUSINESS (ABUS) DEGREE

General Requirements (GR)

Description

The Maricopa County Community College District (MCCCD) Associate in Business General Requirements (ABus-GR) degree requires a total of 62-63 semester credits for the program of study. The degree has three major components: 1) MCCCD General Education, which includes the Arizona General Education Curriculum for Business (AGEC-B); 2) Common Lower Division Program Requirements; and 3) General Electives.

Purpose of the Degree

The ABus-GR degree is designed for students who plan to transfer to Arizona's public universities into majors that articulate with the Associate in Business General Requirements pathway *and for students who plan to complete lower division course work toward a baccalaureate program at other degree granting institutions*. All business majors except Accountancy and Computer Information Systems should follow the ABus-GR pathway. Accountancy majors should follow the Transfer Guide (TG-XR) pathway. Computer Information Systems majors should follow the Associate in Business Special Requirements pathway.

The degree transfers as a block without loss of credit to Arizona's public universities *and other institutions with district-wide articulation agreements*. All semester credits used to satisfy the MCCCD Associate in Business General Requirements will apply to university graduation requirements of the university major for which the ABus-GR was designed, regardless of whether the credit was awarded for completion of course work or for prior learning. For additional information on credit awarded for prior learning assessment, see the policy on Credit for Prior Learning, page 13.

Academic Policies that Govern the Associate in Business General Requirements Degree

- Requires 62-63 semester credits in courses numbered 100 and above to be completed with a grade of C or better;
- Uses the following policies to help students complete the required Core and Awareness Areas in AGECE-B without exceeding the 35 semester credits:
 1. Courses can satisfy a Core Area and one or two Awareness Areas simultaneously.
 2. A course cannot be used to satisfy more than one Core Area requirement.
- Uses the following policy to help students complete the program requirements at a minimum of 62 semester credits but not more than 63 semester credits:

Courses can satisfy multiple areas within the degree simultaneously (AGECE-B Core Area, AGECE-B Awareness Area, and/or Common Lower Division Program Requirements).
- Follows the general education policy below:

General Education Designations (example: (FYC), [SB], [HU], etc.) Effective Fall 2000, the course evaluation and/or general education designation as listed in the Arizona CEG (Course Equivalency Guide) within the Arizona Course Applicability System (AZCAS) is valid for the **term** in which the student is awarded credit on the transcript. A course evaluation and/or general education designation may be subject to change. Given that curriculum is dynamic at both MCCCD and the institutions to which MCCCD students transfer, students have the option to petition for general education evaluations and/or general education designations.

- Requires courses that transfer as an equivalent course, departmental elective credit (XXXXDEC), or general elective credit (Elective) at all Arizona public universities according to the Arizona Course Equivalency Guide (CEG) within the Arizona Course Applicability System (AZCAS). The course evaluation and/or general education designation as listed in AZCAS is valid for the term in which the student is awarded credit on the transcript;
- Follows the graduation policies within the general catalog;
- Includes both courses and their modular equivalents, either the course or the modular equivalents will satisfy the Associate in Business General Requirements;
- Accepts one of the courses that is cross-referenced with other courses;
- Provides for exemption from Arizona university admission requirements for students who complete the ABus-GR degree from a regionally accredited post-secondary institution with a minimum 2.0 GPA on a 4.0=A scale for Arizona residents and a minimum 2.5 GPA on a 4.0=A scale for nonresidents.

Degree Requirements

The 62-63 semester credits required for the Associate in Business General Requirements (ABus-GR) follow. See the list entitled [MCCCD Courses That Can Be Used to Satisfy MCCCD AGECE-A, AGECE-B and/or AGECE-S](#), page 36, for specific course information. The most up-to-date information can be accessed via the following web address:

<http://www.maricopa.edu/academic/curric/>

Select tab labeled *Curriculum Procedures Handbook - Programs*

Select *Academic Programs*

Select *Matrix of MCCCD Courses* (AGECE Course Matrix)

The list identifies the courses in alpha-order by prefix as well as the different Core Areas and Awareness Areas where the course will apply. When selecting Mathematical Studies and Natural Sciences options, select from the appropriate AGECE-A, B or S list.

I. MCCCD General Education

Credits

A. MCCCD AGECE-B

35

I. Core Areas

- a. First-Year Composition (FYC) 6
- b. Literacy and Critical Inquiry [L] 3
- c. Mathematical Studies [MA/CS] 6
To complete the Mathematical Studies requirement, select one course to satisfy the Mathematics [MA] B and a second course from Computer/Statistics/Quantitative Applications [CS].
 - 1) Mathematics [MA] B (3 credits)
MAT212, Brief Calculus, or a higher level mathematics course
AND
 - 2) Computer/Statistics/Quantitative Applications [CS] (3 credits)
Note: Students are encouraged to select GBS221 or CIS105 to satisfy [CS].
- d. Humanities and Fine Arts [HU] 6
Students are encouraged to choose course work from more than one discipline for a total of six (6) semester credits.

Associate in Business (ABus) General Requirements (GR)

- e. **Social and Behavioral Sciences [SB]** 6
Students are encouraged to choose course work from more than one discipline for a total of six (6) semester credits.
- f. **Natural Sciences [SQ/SG]** 8
To complete the Natural Sciences requirement:
Select four (4) semester credits of [SQ] and four (4) semester credits of [SG] for a total of eight (8) semester credits, **OR** eight (8) semester credits of [SQ]. Students **cannot** take eight (8) semester credits of [SG] to meet the Natural Sciences requirement.

The lecture course(s) selected for Natural Sciences must include or be accompanied by the corresponding laboratory course. The lecture and corresponding laboratory course(s) may carry separate credit. Students should consult with an advisor for appropriate course selection. Students should also access the Arizona Course Equivalency Guide (CEG) within the Arizona Course Applicability System (AZCAS) for information on equivalencies.

2. Awareness Areas

Students must satisfy two Awareness Areas: Cultural Diversity in the United States [C] and either Global Awareness [G] or Historical Awareness [H]. However, it is not necessary for students to exceed thirty-five (35) semester credits to complete the Awareness Areas because courses can satisfy a Core Area and one or two Awareness Areas simultaneously. Therefore, no additional semester credits are required to satisfy the two Awareness Areas.

- Cultural Diversity in the United States [C]
- AND
- Global Awareness [G]
- OR
- Historical Awareness [H]

II. Common Lower Division Program Requirements 27-28

A total of 27-28 credits is required to satisfy the Common Lower Division Program Requirements. However, if students select courses that simultaneously satisfy multiple areas of the degree; then the number of semester credits required for Common Lower Division Program Requirements is reduced. Additional semester credits may be required in General Electives to complete the minimum 62-63 total program semester credits.

Complete the following:

Accounting 6-7

- *ACC111 & ACC230 & ACC240
- OR
- **ACC211 & ACC212

- *MCCCD ACC250 or ACC211 may be taken in lieu of ACC111.
- **MCCCD ACC111 and ACC112 together are equivalent to ACC211.

- CIS105 [CS]** 3
- ECN111 [SB]** 3
- ECN112 [SB]** 3
- GBS205** 3
- GBS220 or MAT172 [MA]** 3
- GBS221 [CS]** 3

Business Elective

3

Select from the following options:

- CIS158 [CS] COBOL Programming I
- CIS159 [CS] Visual Basic Programming I
- CIS162AA [CS] C: Level I
- CIS162AB [CS] C++: Level I
- CIS162AC [CS] Visual C++: Level I
- CIS162AD [CS] C#: Level I
- CIS163AA [CS] Java Programming: Level I
- GBS151 Introduction to Business
- GBS233 [L] Business Communication
- MGT251 Human Relations in Business
- MGT253 Owning and Operating a Small Business
- REA179 Real Estate Principles I

III. General Electives

Select courses to complete a minimum of 62 semester credits but no more than a total of 63 semester credits. General Elective semester credits may be necessary if courses selected for the degree satisfy multiple areas. For appropriate course selection, students should consult an advisor.

Students must select courses that are acceptable as an equivalent course, departmental elective credit (XXXXDEC), or general elective credit (Elective) at all Arizona public universities according to the Arizona Course Equivalency Guide (CEG) within the Arizona Course Applicability System (AZCAS) (see web address below). For appropriate course selection, students should consult with an advisor.

<http://az.transfer.org/cas/atass/index.html>

Select *Student Information* followed by:

Course Applicability System (CAS)

Course Equivalency Guide (CEG)

Maricopa Community College District

ABus-General Requirements Total Credits: 62-63

ASSOCIATE IN BUSINESS (ABUS) DEGREE

Special Requirements (SR)

Description

The Maricopa County Community College District (MCCCD) Associate in Business Special Requirements (ABus-SR) degree requires a total of 62-63 semester credits for the program of study. The degree has three major components: 1) MCCCD General Education, which includes the Arizona General Education Curriculum for Business (AGEC-B); 2) Common Lower Division Program Requirements; and 3) General Electives.

Purpose of the Degree

The ABus-SR degree is designed for Computer Information Systems majors who plan to transfer to Arizona's public universities *and for students who plan to complete lower division course work toward a baccalaureate program at other degree granting institutions*. Currently the pathway for accountancy majors is a Transfer Guide Pathway (TG-XR). The Associate in Business General Requirements (ABus GR) is designed for all other business majors. Additional information on academic majors at the Arizona public universities can be accessed via the following web address:

<http://az.transfer.org/cas/atass/index.html>

Select *Student Information* followed by:
Degrees and Pathways

The Associate in Business Special Requirements transfers as a block without loss of credit to Arizona's public universities *and other institutions with district-wide articulation agreements*. All semester credits used to satisfy the MCCCD Associate in Business Special Requirements will apply to university graduation requirements of the university major for which the ABus-SR was designed, regardless of whether the credit was awarded for completion of course work or for prior learning. For additional information on credit awarded for prior learning assessment, see the policy on Credit for Prior Learning, page 13.

Academic Policies that Govern the Associate in Business Special Requirements Degree

- Requires 62-63 semester credits in courses numbered 100 and above to be completed with a grade of C or better;
- Uses the following policies to help students complete the required Core and Awareness Areas in AGECE-B without exceeding the 35 semester credits:
 1. Courses can satisfy a Core Area and one or two Awareness Areas simultaneously.
 2. A course cannot be used to satisfy more than one Core Area requirement.
- Uses the following policy to help students complete the program requirements at a minimum of 62 semester credits but not more than 63 semester credits:

Courses can satisfy multiple areas within the degree simultaneously (AGECE-B Core Area, AGECE-B Awareness Area, and/or Common Lower Division Program Requirements).
- Follows the general education policy below:

General Education Designations (example: (FYC), [SB], [HU], etc.)
Effective Fall 2000, the course evaluation and/or general education designation as listed in the Arizona CEG (Course Equivalency Guide) within the Arizona Course Applicability System (AZCAS) is valid for the **term** in which the student is awarded credit on the transcript. A course evaluation and/or general education designation may be subject to change. Given that curriculum is dynamic at both MCCCD and the

institutions to which MCCCD students transfer, students have the option to petition for course evaluations and/or general education designations.

- Requires courses that transfer as an equivalent course, departmental elective credit (XXXXDEC), or general elective credit (Elective) at all Arizona public universities according to the Arizona Course Equivalency Guide (CEG) within the Arizona Course Applicability System (AZCAS). The course evaluation and/or general education designation as listed in AZCAS is valid for the term in which the student is awarded credit on the transcript;
- Follows the graduation policies within the general catalog;
- Includes both courses and their modular equivalents, either the course or the modular equivalents will satisfy the Associate in Business Special Requirements;
- Accepts one of the courses that is cross-referenced with other courses;
- Provides for exemption from Arizona university admission requirements for students who complete the ABus-SR degree from a regionally accredited post-secondary institution with a minimum 2.0 GPA on a 4.0=A scale for Arizona residents and a minimum 2.5 GPA on a 4.0=A scale for nonresidents.

Degree Requirements

The 62-63 semester credits required for the Associate in Business Special Requirements (ABus-SR) follow. See the list entitled [MCCCD Courses That Can Be Used to Satisfy MCCCD AGECE-A, AGECE-B and/or AGECE-S](#), page 36, for specific course information. The most up-to-date information can be accessed via the following web address:

<http://www.maricopa.edu/academic/curric/>

Select tab labeled *Curriculum Procedures Handbook - Programs*

Select *Academic Programs*

Select *Matrix of MCCCD Courses* (AGECE Course Matrix)

The list identifies the courses in alpha-order by prefix as well as the different Core Areas and Awareness Areas where the course will apply. When selecting Mathematical Studies and Natural Sciences options, select from the appropriate AGECE-A, B, or S list.

I. MCCCD General Education

Credits

A. MCCCD AGECE-B

35

I. Core Areas

- a. First-Year Composition (FYC) 6
 - b. Literacy and Critical Inquiry [L] 3
 - c. Mathematical Studies [MA/CS] 6
- To complete the Mathematical Studies requirement, select one course to satisfy the Mathematics [MA] B and a second course from Computer/Statistics/Quantitative Applications [CS].
- 1) Mathematics [MA] B (3 credits)
MAT212, Brief Calculus, or a higher level mathematics course
AND
 - 2) Computer/Statistics/Quantitative Applications [CS] (3 credits)
- Note: Students are encouraged to select GBS221 or CIS105 to satisfy [CS].

Associate in Business (ABus) Special Requirements (SR)

- d. Humanities and Fine Arts [HU] 6
Students are encouraged to choose course work from more than one discipline for a total of six (6) semester credits.
- e. Social and Behavioral Sciences [SB] 6
Students are encouraged to choose course work from more than one discipline for a total of six (6) semester credits.
- f. Natural Sciences [SQ/SG] 8
To complete the Natural Sciences requirement:
Select four (4) semester credits of [SQ] and four (4) semester credits of [SG] for a total of eight (8) semester credits, OR eight (8) semester credits of [SQ]. Students **cannot** take eight (8) semester credits of [SG] to meet the Natural Sciences requirement.

The lecture course(s) selected for Natural Sciences must include or be accompanied by the corresponding laboratory course. The lecture and corresponding laboratory course(s) may carry separate credit. Students should consult with an advisor for appropriate course selection. Students should also access the Arizona Course Equivalency Guide (CEG) within the Arizona Course Applicability System (AZCAS) for information on equivalencies.

2. Awareness Areas

Students must satisfy two Awareness Areas: Cultural Diversity in the United States [C] and either Global Awareness [G] or Historical Awareness [H]. However, it is not necessary for students to exceed thirty-five (35) semester credits to complete the Awareness Areas because courses can satisfy a Core Area and one or two Awareness Areas simultaneously. Therefore, no additional semester credits are required to satisfy the two Awareness Areas.

- Cultural Diversity in the United States [C]
- AND
- Global Awareness [G]
- OR
- Historical Awareness [H]

II. Common Lower Division Program Requirements 27-28

A total of 27-28 credits is required to satisfy the Common Lower Division Program Requirements. Common courses meeting general education areas are noted with the general education designations encased in brackets.

Complete the following:

Accounting **6-7**

*ACC111 & ACC230 & ACC240

OR

**ACC211 & ACC212

*MCCCD ACC250 or ACC211 may be taken in lieu of ACC111.

**MCCCD ACC111 and ACC112 together are equivalent to ACC211.

Programming I (Visual Basic) **3**
CIS159 [CS]

Programming II (Java) **3**
CIS163AA [CS]

ECN111 [SB] **3**

ECN112 [SB] **3**

GBS205 **3**

GBS220 or MAT172 [MA] **3**

GBS221 [CS] **3**

III. General Electives

Select courses to complete a minimum of 62 semester credits but no more than a total of 63 semester credits for the program. General Elective semester credits may be necessary if courses selected for the degree satisfy multiple areas. For appropriate course selection, students should consult an advisor.

Students must select courses that are acceptable as an equivalent course, departmental elective credit (XXXXDEC), or general elective credit (Elective) at all Arizona public universities according to the Arizona Course Equivalency Guide (CEG) within the Arizona Course Applicability System (AZCAS) (see web address below). For appropriate course selection, students should consult with an advisor.

<http://az.transfer.org/cas/atass/index.html>

Select *Student Information* followed by:

Course Applicability System (CAS)

Course Equivalency Guide (CEG)

Maricopa Community College District

ABus-Special Requirements Total Credits: 62-63

ASSOCIATE IN TRANSFER PARTNERSHIP (ATP) DEGREE

Purpose of the Degree

The Maricopa County Community College District (MCCCD) Associate in Transfer Partnership (ATP) degree is designed to meet the needs of Maricopa Community College students transferring to public and private colleges and universities. This degree is developed specifically for students who have an identified major and have selected the baccalaureate degree-granting institution to which they intend to transfer.

The Associate in Transfer Partnership degree is an articulated academic program of study established among the student, the accredited baccalaureate degree-granting institution selected by the student, and the primary Maricopa Community College the student attends. The program of study will parallel the student's four-year degree as designated by the baccalaureate degree-granting institution. That is, the courses and number of credit hours in the degree will consist of the freshman and sophomore lower division course degree requirements of the major as jointly planned and agreed on with the community college and the accredited institution to which the student plans to transfer.

The ATP degree requires a core of general education credits in the following general education categories: First-Year Composition (6 credits); Mathematics (3 credits); Natural Sciences (4 credits); and Humanities and Fine Arts/Social and Behavioral Sciences, or related area general education requirements (6 credits). Also included in the ATP degree are the general education and major requirements to meet the lower division requirements of the major at the baccalaureate degree-granting institution. The ATP degree must consist of at least a minimum of 60 credit hours. The ATP degrees are accessible on the following web site:

<http://www.maricopa.edu/academic/curric/>

Select *Curriculum Procedures Handbook - Programs*
Followed by *Academic Programs* to access ATPs

Exemption From Arizona University

Admission Requirements

The Associate in Transfer Partnership degree provides for exemption from Arizona university admission requirements for students who complete the degree from a regionally accredited post-secondary institution with a minimum 2.0 GPA on a 4.0=A scale for Arizona residents and a minimum 2.5 GPA on a 4.0=A scale for nonresidents.

The ATP degree does not assure admission to the specific program at the baccalaureate degree-granting institution. Students participating in the ATP degree will be treated as native students by the upper division institution in terms of course evaluation and course changes.

Advising is a critical element of the transfer partnership degree, and students must work closely with a community college academic advisor prior to entering into a transfer partnership agreement. Once a transfer partnership agreement has been initiated by the student, approved and signed off by a community college academic advisor and university authorized official, the student is responsible for periodic meetings with the community college advisor and, if/when determined necessary, with the appropriate baccalaureate degree-granting institution academic advisor. Upon completion of 36 hours, students must receive formal advising at a Maricopa Community College before the remainder of their classes can be scheduled.

Elements of the Associate in Transfer Partnership (ATP) Degree

Element	Credits
MCCCD General Education Core	19
Approved Lower Division Transfer Courses	Variable
(Major dependent with maximum to be determined by receiving baccalaureate degree-granting institution)	
Associate in Transfer Partnership	
Degree Total Hours	60 Minimum

Associate in Transfer Partnership degrees are available in the following areas. Other ATP degrees may be added later depending on curricular needs:

- Accountancy
- American Indian Studies
- Computer Information Systems
- Construction
- Early Childhood Teacher Education
- Exercise and Wellness
- General Business
- Global Business
- Housing and Urban Development
- K-12 Classroom Instructional Support
- Kinesiology
- Molecular Biosciences/Biotechnology
- Nursing
- Nutrition
- Psychology
- Recreation
- Social Work

ASSOCIATE IN GENERAL STUDIES (AGS) DEGREE

Description

The Maricopa County Community College District (MCCCD) Associate in General Studies (AGS) degree is recommended for students whose educational goals require flexibility. The AGS allows students to choose any elective courses numbered 100 or above to complete the degree. Therefore, this degree may be less appropriate for students who intend to transfer to a baccalaureate-granting institution.

Students who demonstrate skills comparable to those in Critical Reading and/or Mathematics and/or Computer Usage may substitute acceptable elective courses to satisfy the total credits required for the degree.

Academic Policies that Govern the Associate in General Studies Degree

- Requires a minimum of 60 semester credits in courses numbered 100 and above.
- AGS degree requirements follow with the use of a diagonal character (/) between course numbers to signify options. An asterisk (*) following the course number defines requirements with an effective begin term of spring;
- Requires grades as listed for specific areas such as the General Education Core where a minimum grade of C is required. Courses applied to other areas may be completed with a minimum grade of D ;
- Uses the following policies for course(s) satisfying multiple program areas:
 1. A course can simultaneously satisfy one Core Area and one Distribution Area. Courses that meet this criterion are **bold** print and underscored in the Core Areas and Distribution Areas.
 2. A course cannot satisfy more than one Core Area, even if it is approved for more than one Core Area.
 3. A course cannot satisfy more than one Distribution Area, even if it is approved for more than one Distribution Area;
- Follows the graduation policies within the general catalog;
- Includes both courses and their modular equivalents; either the course or the modular equivalents will satisfy the Associate in General Studies;
- Accepts one of the courses that is cross-referenced with other courses;
- Provides for exemption from Arizona university admission requirements for students who complete the Associate in General Studies degree from a regionally accredited post-secondary institution with a minimum 2.0 GPA on a 4.0=A scale for Arizona residents and a minimum 2.5 GPA on a 4.0=A scale for nonresidents.

Degree Requirements

GENERAL EDUCATION CORE (16 credits with a grade of "C" or better)

First-Year Composition: 6 credits

ENG English [101/107] & [102/108]

Oral Communication: 3 credits

COM Communication 100/100AA & 100AB & 100AC/110/110AA & 110AB & 110AC/225/230

Critical Reading: 3 credits

CRE Critical Reading 101/Equivalent as indicated by assessment

Mathematics: 3 credits

MAT Mathematics 102/105/120/121/122/122AA/122AB/122AC/126/140/141/142/150/151/151AA/151AB/151AC/151AD/152/156/172/182/187/206/212/216/220/221/225/226/227/230/231/236/240/241/251/261/262/equivalent course/Satisfactory completion of a higher level mathematics course.

GBS General Business 220

Computer Usage: 1 credit

Computer-related course or demonstration of comparable computer skills. Additional courses may be approved by individual colleges. Students should contact their advisor for college-specific courses satisfying the requirement.

ACC Accounting 115/115AA/115AB/115BA/115BB
ADA Advertising Arts 169/170/170AA/170AB/173/173AA/173AB/173AC/175/175AA/175AB/177/177AA/177AB/any 180 modules/183/183AA/183AB/183AC/283/283AA/283AB/283AC/289/289AA/289AB/289AC
AGB Agribusiness 139
AJS Administration of Justice Studies 117/119/205
AGB Agribusiness 139
ARC Architecture 243/244/245
BIO Biology 219
BPC Business-Personal Computers Any BPC Course(s)
CFS Child/Family Studies 180
CIS Computer Information Systems Any CIS Course(s)
CSC Computer Science Any CSC Course(s)
CTR Court Reporting 101/102
DFT Drafting Technology 103/105/any 105 module/150/251/any 251 module/253/any 253 module/any 254 module/any 256 module
ECE Engineering Science 102/102AA/103/103AB/139
ECH Early Childhood Education 238
EEE Electrical Engineering 120
ELE Electronic 115/131/150/181/241/243/245/281
ELT Electronic Technology 131/131AA/131AB/241/243/249/273/281/282
ENG English 100AE
FON Food and Nutrition 100/100AA/100AC/100AD/140BC
GPH Physical Geography 219/220
HRM Hotel Restaurant Management 126
JRN Journalism 133
LAS Legal Assisting 229
LBT Library Technology 106
MAT Mathematics 206
MET Manufacturing Technology 105AA/140/264
MTC Music Theory/Composition 191
NET Networking Technology 181/181AA/181AB/247
OAS Office Automation Systems 111AA/111AB/113/113AA & 113AB/119/130/any 130 module/any 135 module/any 235 module
PSY Psychology 230
QCT Quality Control Technology 274
SBS Small Business 211
SMT Semiconductor Manufacturing Technology 131/131AA/131AB/150
TCM Telecommunications 106
TVL Travel Agent Technology 203/205
VPT Video Production Technology 106

Associate in General Studies (AGS) Degree

GENERAL EDUCATION DISTRIBUTION AREAS (28-29 credits)

Humanities and Fine Arts: 9 credits

Students are encouraged to choose courses from more than one discipline. Select nine (9) credits from the following:

AIS	American Indian Studies 213
AJS	Administration of Justice Studies 123
ARH	Art Humanities Any ARH Course(s)
ASB	Anthropology 202/211/222/223
COM	Communication 241
DAH	Dance Humanities 100/201
EDU	Education 291/292/294
ENG	English 200/260
ENH	English Humanities Any ENH Course(s)
FRE	French 265/266
HCR	Health Care Related 210
HIS	History 101/102/103/109/111/243
HUM	Humanities Any HUM Course(s) (EXCEPT 203, 207)
INT	Interior Design 105/115/120/225
LAT	Latin 201/202
MHL	Music: History/Literature 140/143/145/146/147/153/155
PHI	Philosophy Any PHI Course(s) (EXCEPT 113)
REL	Religious Studies Any REL Course(s)
SPA	Spanish 241/242/265/266
SPH	Spanish Humanities 150/151/245
STO	Storytelling 292/294
SWU	Social Work 102/171/258/292
TCM	Telecommunications 145
THE	Theatre 111/205/206/210/220/260
THP	Theatre Performance/Production 241
WST	Women's Studies 209/284/285

Social and Behavioral Sciences: 9 credits

Students are encouraged to choose courses from more than one discipline.

AFR	African American Studies 110/202/203/204
AIS	American Indian Studies 101/105/140/141/160/170
AJS	Administration of Justice Studies 119/200/225/258/259/270
ASB	Anthropology 100/102/202/211/214/222/223/230/235/238/245
ASM	Anthropology 104
CFS	Child/Family Studies 157/159/176/205/258/259
COM	Communication 100/100AA & 100AB & 100AC/110/110AA & 110AB & 110AC/230/250/263
ECH	Early Childhood Education 176
ECN	Economics Any ECN Course(s)
EDU	Education 221/222
EMT	Emergency Medical Technology 258
FSC	Fire Science Technology 258
FUS	Future Studies 101
GBS	General Business 280
GCU	Cultural Geography 102/121/122/141/221/223/253
HES	Health Science 100
HIS	History Any HIS Course(s)
IBS	International Business 109
MCO	Mass Communications 120
PHI	Philosophy 243
POS	Political Science Any POS Course(s)
PSY	Psychology 101/123/132/156/157/215/218/225/235/240/245/250/258/259/260/266/270/277/280/281/292
REC	Recreation 120/160
REL	Religious Studies 243
SBU	Society and Business 200

SOC	Sociology Any SOC course(s) (EXCEPT 242)
SWU	Social Work 102/171/258/292
TEC	Textiles and Clothing 105/106
WED	Wellness Education 100/110
WST	Women's Studies 100/105/110/120/160/161
YAQ	Yaqui Indian History and Culture 100

Natural Sciences: 7-8 credits

Two lecture courses and one corresponding laboratory course are to be selected. The lecture and corresponding laboratory course(s) may carry separate credit. For appropriate course selection students should consult with an advisor.

AGS	Agricultural Science 164/183
ASB	Anthropology 231
ASM	Anthropology 104/265
AST	Astronomy 101/102/111/112/113/114
BIO	Biology 100/101/102/105/107/108/109/145/149AF/149AH/149AI/149AJ/149AK/149AL/149AM/149AN/150/156/160/181/182/201/205/241/247
CHM	Chemistry 107/107LL/130/130LL/151/151LL/152/152LL/154/154LL/230/230LL
FON	Food and Nutrition 241
FOR	Forensic Science 105
GLG	Geology Any GLG Course(s)
GPH	Physical Geography 111/112/113/210/211/212 & 214/213 & 215
ISS	Interdisciplinary Science Studies 111/112
PHS	Physical Science 110/120
PHY	Physics 101/111/112/115/116/121/131/252
PSY	Psychology 290AB/290AC

Literacy and Critical Inquiry: 3 credits

AIS	American Indian Studies 213
CCS	Chicana and Chicano Studies 101
COM	Communication 207/222/225/230/241
CRE	Critical Reading 101
DAH	Dance Humanities 201
ENG	English 111/200/213/215/216/217/218
ENH	English Humanities 254/255
FON	Food and Nutrition 206
GBS	General Business 233
GPH	Physical Geography 211/212 & 214
HCR	Health Care Related 220
HUM	Humanities 250/251
IFS	Information Studies 101
IGS	Integrated Studies 290AA & 290AB/291/293
JRN	Journalism 201/212/234
MCO	Mass Communication 220
MHL	Music: History/Literature 140
PHI	Philosophy 103/106/225
POS	Political Science 115
PSY	Psychology 290AB/290AC
REL	Religious Studies 101/203/205/225
THE	Theatre 220
THP	Theatre Performance/Production 241

ELECTIVE COURSES (15-16 credits)

May select courses from prefixes already chosen for General Education Distribution requirements in order to develop depth in one or more subject areas.

AGS Total Credits:

Minimum of 60

ASSOCIATE IN APPLIED SCIENCE (AAS) DEGREE

Purpose of the Degree

The Maricopa County Community College District (MCCCD) Associate in Applied Science (AAS) degree is recommended for students who wish to gain a depth of technical expertise by completing an occupational program presented in the college catalog. Students should consult this catalog to determine specific program requirements.

Academic Policies that Govern the AAS Degree

- Requires 60 or more credits numbered 100 or above and includes credits or the equivalent in the General Education Core areas and credits in the Distribution areas. AAS degree requirements follow with the use of a diagonal character (/) between course numbers to signify options. An asterisk (*) following the course number defines requirements with an effective begin term of spring;
- Requires grades as listed for specific areas such as the General Education Core where a minimum grade of C is required. See specific AAS occupational degree for specific program grade requirements;
- Follows the graduation policies within the general catalog;
- Includes both courses and their modular equivalents, either the course or the modular equivalents will satisfy the Associate in Applied Science requirements;
- Requires at least 12 semester credit hours earned at the college awarding the AAS degree. The 12 hours in the AAS degree curricula may be in the Required Courses area and/or Restricted Electives courses. Courses from the General Education Core and Distribution area are excluded;

Shared Programs are programs offered at multiple colleges but not available at all colleges. The requirements are identical at all the colleges offering the program.

A shared program requires a minimum of six (6) credit hours from the total program requirements to be completed with a grade of "C" or better at the college awarding the certificate or degree. The exception is the Nursing program. For those shared programs with less than six (6) credit hours, the total hours for the program must be completed at the college awarding the certificate. The minimum of six (6) credit hours in the certificate or degree curricula may be in the Required Courses area and/or the Restricted Electives. Courses from the General Education Core and Distribution areas are excluded.

Students must apply for graduation from the college where they have successfully completed Block 4 of the Associate in Applied Science in Nursing.

- Requires completion of General Education courses as indicated in the General Education Requirements for the Associate in Applied Science degree from the Maricopa County Community College District, or completion of a curriculum as stated in the catalog;
- Accepts one of the courses that is cross-referenced with other courses;
- Provides for exemption from Arizona university admission requirements for students who complete the Associate in Applied Science (AAS) degree from a regionally accredited post-secondary institution with a minimum 2.0 GPA on a 4.0=A scale for Arizona residents and a minimum 2.5 GPA on a 4.0=A scale for nonresidents.

GENERAL EDUCATION CORE (15 credits with a grade of "C" or better)

Demonstrate college-level skills in the following areas:

First-Year Composition: 6 credits

ENG English [101/107] & [102/108/111]

Oral Communication: 3 credits

COM Communication 100/100AA & 100AB & 100AC/110/110AA & 110AB & 110AC/225/230

Critical Reading: 3 credits

CRE Critical Reading 101/111/Equivalent as indicated by assessment

Mathematics: 3 credits

MAT Mathematics 102/105/120/121/122/122AA/122AB/122AC/126/140/141/142/150/151/151AA/151AB/151AC/151AD/152/156/172/182/187/206/212/216/220/221/225/226/227/230/231/236/240/241/251/261/262/equivalent course/Satisfactory completion of a higher level mathematics course.

GBS General Business 220

GENERAL EDUCATION DISTRIBUTION AREAS (9-10 credits)

Humanities and Fine Arts: 2-3 credits

Students are encouraged to choose courses from more than one discipline.

AIS American Indian Studies 213
AJS Administration of Justice Studies 123
ARH Art Humanities Any ARH Course(s)
ASB Anthropology 202/211/222/223
COM Communication 241
DAH Dance Humanities 100/201
EDU Education 291/292/294
ENG English 200/260
ENH English Humanities Any ENH Course(s)
FRE French 265/266
HCR Health Care Related 210
HIS History 101/102/103/111/243
HUM Humanities Any HUM Course(s) (EXCEPT 203, 207)
INT Interior Design 115/120/225
LAT Latin 201/202
MHL Music: History/Literature 140/143/145/146/147/153/155
PHI Philosophy Any PHI Course(s) (EXCEPT 113)
REL Religious Studies Any REL Course(s)
SPA Spanish 241/242/265/266
SPH Spanish Humanities 150/151/245
STO Storytelling 292/294
TCM Telecommunications 145
THE Theatre 111/205/206/210/220/260
THP Theatre Performance/Production 241
WST Women's Studies 209/284/285

Associate in Applied Science (AAS) Degree

Social and Behavioral Sciences: 3 credits

Students are encouraged to choose courses from more than one discipline.

AFR	African American Studies 110/202/203/204
AIS	American Indian Studies 101/105/140/141/160/170
AJS	Administration of Justice Studies 200/258/259/270
ASB	Anthropology 100/102/202/211/214/222/223/230/235/238/245
ASM	Anthropology 104
CFS	Child/Family Studies 157/159/176/205/259
COM	Communication 100/100AA & 100AB & 100AC/110/110AA & 110AB & 110AC/230/250/263
ECH	Early Childhood Education 176
ECN	Economics Any ECN Course(s)
EDU	Education 221/222
EMT	Emergency Medical Technology 258
FSC	Fire Science 258
FUS	Future Studies 101
GBS	General Business 280
GCU	Cultural Geography 102/121/122/141/221/223/253
HES	Health Science 100
HIS	History Any HIS Course(s)
IBS	International Business 109
MCO	Mass Communications 120
PHI	Philosophy 243
POS	Political Science Any POS Course(s)
PSY	Psychology 101/123/125/132/156/157/215/218/225/235/240/245/250/258/259/260/266/270/277/280/281/292
REC	Recreation 120/160
REL	Religious Studies 243
SBU	Society and Business 200

SOC	Sociology Any SOC course(s) (<i>EXCEPT</i> 242)
SWU	Social Work 102/171/258/292
TEC	Textiles and Clothing 105/106
WED	Wellness Education 100/110
WST	Women's Studies 100/105/110/120/160/161
YAQ	Yaqui Indian History and Culture 100

Natural Sciences: 4 credits

The lecture course(s) selected for Natural Sciences must include or be accompanied by the corresponding laboratory course. The lecture and corresponding laboratory course(s) may carry separate credit. Students should consult with an advisor for appropriate course selection.

AGS	Agricultural Science 164
ASB	Anthropology 231
ASM	Anthropology 104/265
AST	Astronomy 101/102/111/112/113/114
BIO	Biology 100/101/102/105/107/108/109/145/149AN/150/156/160/181/182/201/205/241/247
CHM	Chemistry 107/107LL/130/130LL/151/151LL/152/152LL/154/154LL/230/230LL
FON	Food and Nutrition 241
FOR	Forensic Science 105
GLG	Geology Any GLG Course(s) (<i>EXCEPT</i> 140/251MC/275)
GPH	Physical Geography 111/112/113/212 & 214/213 & 215
ISS	Interdisciplinary Science Studies 111/112
PHS	Physical Science 110/120
PHY	Physics 101/111/112/115/116/121/131/252
PSY	Psychology 290AB/290AC

AAS Total Credits:

Minimum of 60

ACADEMIC CERTIFICATE

Purpose of the Academic Certificate

The Maricopa Community College District Academic Certificate (area of emphasis) is a defined and coherent program of study that is recommended for students who wish to gain additional expertise in an academic area. While this program of study can result in proficiency in specified skills and competencies, as well as mastery of knowledge, it is not designed to prepare someone for employment in a specific occupation. The content for an Academic Certificate (area of emphasis) may be derived from a variety of disciplines or it can be discipline specific. The Academic Certificate does not require a general education component even though requirements of the certificate may include courses that currently meet specific general education designations such as Humanities and Fine Arts, Social and Behavioral Sciences, etc.

Academic Policies that Govern the Academic Certificate

- generally ranges from 12-39 credit hours in courses numbered 100 or above, although there is no minimum number of credit hours required for an Academic Certificate;

- requires a cumulative GPA of 2.0 or better for completion;
- follows the graduation policies within the general catalog;
- accepts one of the courses that is cross-referenced with other courses;
- includes both courses and their modular equivalents, either the course or the modular equivalents will satisfy the Academic Certificate requirements;
- does not presume block transfer value; consequently, in most cases the Academic Certificate should not be a subset of an existing transfer degree;
- may have admission criteria established by the college if and when appropriate;
- is for the most part college specific.

GENERAL GRADUATION REQUIREMENTS (AR 2.3.9)

All students are required to complete the degree and/or certificate requirements as approved by the MCCC Governing Board. The college reserves the right to make necessary course and program changes in order to meet current educational standards. In addition, students must:

1. Be credited in the Office of Admissions and Records with not fewer than: 60 semester credit units in courses numbered 100 or above for the Associate in Arts degree, Associate in Science degree, Associate in Transfer Partnership degree, and Associate in General Studies degree; 60 semester credit units for the Associate in Applied Science degree; 62 semester credit units for the Associate in Business degrees. For specific certificate programs, be credited with not fewer than the minimum total of credit units required for the certificate program.

Students not continuously enrolled, as outlined in the Catalog Under Which a Student Graduates policy, must satisfy current graduation requirements.

2. Have earned a minimum of twelve (12) semester credit units toward the degree or certificate at the district college granting the degree or certificate. In cases where the certificate requires fewer than 12 credit units, a minimum of six credit units must be completed at the college awarding the certificate.
3. Have filed an application for the degree or certificate with the Office of Admissions and Records on the date determined by the college/center.

Students must apply for graduation from the college where they have successfully completed Block 4 of the Associate in Applied Science in Nursing.

4. Have a minimum cumulative grade point average (GPA) of 2.000 at the college granting the degree.
5. Have a minimum cumulative grade point average (GPA) of 2.000 in all courses used to fulfill degree requirements.

(Some specific programs have higher grade requirements. It is the student's responsibility to be aware of these program requirements.)

6. Have removed, thirty (30) days after the anticipated graduation date, all deficiencies on the record to use those courses toward program completion.
7. Have removed any indebtedness to any MCCC college/center.
8. Have paid required degree or certificate application fee. See fee schedule for charges.

See Graduation with Honors for information on honors designation.

Graduation Grade Point Average

Students must meet all requirements for graduation. Graduation requires a **minimum** grade point average of 2.00. Some specific programs have higher grade requirements. It is the student's responsibility to be aware of these program requirements. For more information, see the above General Graduation Requirements section.

Graduation with Honors

All courses used to fulfill graduation requirements, including courses from other accredited institutions, will be entered in the grade point average calculation for honors designations. Students who have the following grade point averages will graduate with the following designations:

3.50 to 3.69	with distinction
3.70 to 3.89	with high distinction
3.90 to 4.0	with highest distinction

Graduation - Honors Program

Students who meet all the requirements of the Honors Program at the district college granting the degree will be designated as Honors Program Graduates.

Certificates/Degrees

The Maricopa Community Colleges offer Certificates of Completion as well as Associate Degrees, one of which is conferred on each student who has completed a program of study. These certificates and degrees are as follows:

1. Certificate of Completion (Career Program Specified);
2. Academic Certificate;
3. General Education Certificate;
4. Associate in Arts;
5. Associate in Science;
6. Associate in Business;
7. Associate in General Studies;
8. Associate in Transfer Partnership;
9. Associate in Applied Science (Career Program Specified).

All candidates for a degree and/or certificate must complete the General Graduation Requirements as approved by the MCCC Governing Board.

All students are urged to meet with a faculty advisor, program advisor or counselor as soon as possible to determine which program meets their needs and to plan their course of study.

Graduate Guarantee Policy

The Governing Board believes so strongly in the quality of its colleges' occupational training programs that it guarantees graduate competence.

1. Graduation from an Associate in Applied Science (AAS) is designed to prepare a person for entry-level employment in a specific career field. A graduate's ability to perform approved program competencies will be judged by employers. Should the employer of a graduate who has earned an AAS Degree find the employee lacking in the technical skills normally expected of an entry-level employee in the specific career field for which that graduate prepared, the District will provide the graduate with up to the equivalent of twelve (12) credit hours of retraining for no additional tuition.
2. Because technical occupations change rapidly, initial employment in an AAS Degree-related field must occur within one year of graduation from the AAS Degree program in question.

Retraining needs to occur as cost effectively as possible. The graduate's employer must present a list of the graduate's skill deficiencies to the appropriate vice president or designee at the graduate's alma mater. All retraining will be completed in a reasonable time as agreed to by the employer, the student, and the college.

Graduation Requirements

Licensure Disclaimer

Maricopa Community Colleges courses and programs prepare students for entry into a variety of professions. Many of these professions require that a person hold an occupational license or certificate in order to work in a particular field. Typically, a person must meet certain legal requirements before obtaining such a license or certificate. These requirements are established by county, state or federal agencies, and often are based on a person's character, or whether the person has been convicted of a criminal offense. It is possible for a student who has obtained a degree or certificate from a community college to be denied the right to work in a particular profession after completing the degree or certificate because of concerns over the student's character or criminal background. Any student preparing to enter a field for which a professional license or certificate is required is strongly advised to consult with the appropriate government agency that issues such credentials. That agency can provide the student complete information about any requirements the law imposes for working in a particular occupation.

MCCCD General Education Statement

The general education core of the program of study for an associate degree or a certificate helps students develop a greater understanding of themselves, of their relationship with others, and of the richly diverse world in which they live. The general education experience provides students with opportunities to explore broad areas of commonly held knowledge and prepares them to contribute to society through personal, social, and professional interactions with others. General education fosters students' personal development by opening them to new directions, perspectives, and processes.

Through its general education requirements, the Maricopa County Community College District is committed to helping students develop qualities and skills that will serve them throughout their lives. General education opportunities encourage students to:

- Build self-awareness, self-respect, and self-confidence
- Recognize and respect the beliefs, traditions, abilities, and customs of all people and all cultures
- Consider the local, global, and environmental impacts of personal, professional, and social decisions and actions
- Access, evaluate, analyze, synthesize, and use information wisely
- Communicate effectively personally, socially, and professionally
- Think critically, make informed decisions, solve problems and implement decisions
- Consider the ethical implications of their choices
- Value the learning process throughout their lives
- Integrate and connect ideas and events in a historical perspective, and see relationships among the past, the present, and the future
- Develop a personal sense of aesthetics
- Use technological resources appropriately and productively
- Work cooperatively and respectfully with others to serve their communities

The general education experience at MCCCD is composed of specific elements across the curriculum designed to provide the learner with essential knowledge and skills:

- Communication
- Arts and Humanities
- Numeracy
- Scientific Inquiry in the Natural and Social Sciences
- Information Literacy
- Problem-Solving and Critical Thinking
- Cultural Diversity

General Education Designations (example: (FYC), [SB], [HU], etc.)

Effective Fall 2000, the course evaluation and/or general education designation as listed in the Arizona CEG (Course Equivalency Guide) within the Arizona Course Applicability System (AZCAS) is valid for the term in which the student is awarded credit on the transcript. A course evaluation and/or general education designation may be subject to change. Given that curriculum is dynamic at both MCCCD and the institutions to which MCCCD students transfer, students have the option to petition for general education evaluations and/or general education designations.

The college reserves the right to make necessary course and program changes in order to meet current educational standards.

University Department Time Limit for Coursework

In areas of study in which the subject matter changes rapidly, material in courses taken long before graduation may become obsolete or irrelevant. Coursework that is more than eight years old is applicable to completion of degree requirements at the discretion of the student's major department. Departments may accept such coursework, reject it, or request that the student revalidate its substance. The eight-year limit on coursework applies except when program accreditation agencies limit the life of coursework to less than eight years. Departments may also require students to satisfy current major requirements, rather than major requirements in earlier catalogs, when completing earlier requirements is no longer possible or educationally sound.

The college reserves the right to make necessary course and program changes in order to meet current educational standards.

Graduation Requirements

Catalog Under Which a Student Graduates (AR 2.2.5) - Appendix C

Students maintaining continuous enrollment at any public Arizona community college or university may graduate according to the requirements of the catalog in effect at the time of initial enrollment or according to the requirements of any single catalog in effect during subsequent terms of continuous enrollment. Students may maintain continuous enrollment whether attending a single public community college or university in Arizona or transferring among public institutions in Arizona while pursuing their degrees.

Continuous Enrollment

1. A semester in which a student earns course credit will be counted toward continuous enrollment. Noncredit courses, audited courses, failed courses, or courses from which the student withdraws do not count toward the determination of continuous enrollment for catalog purposes.

EXAMPLE A:

Admitted and earned course credit at a public community college or university	F93	(Active)
Continued at a public community college	Sp94, F94	(Active)
Transferred to a university	Sp95	(1993 or any subsequent catalog)

EXAMPLE B:

Admitted and earned course credit at a public community college or university	F92	(Active)
Enrolled but earned all W, Z or F grades	Sp93	(Inactive)
Enrolled in audit courses only	F93	(Inactive)
Nonattendance	Sp94	(Inactive)
Transferred to a university	F94	(1994 or any subsequent catalog)

Non-Continuous Enrollment

2. Students who do not meet the minimum enrollment standard stipulated in No. 1 during three consecutive semesters (fall/spring) and the intervening summer term* at any public Arizona community college or university are no longer considered continuously enrolled, and must meet requirements of the public Arizona community college or university catalog in effect at the time they are readmitted or of any single catalog in effect during subsequent terms of continuous enrollment after readmission.

EXAMPLE A:

Admitted and earned course credit at a public community college or university	F92	(Active)
Nonattendance	Sp93, F93, Sp94	(Inactive)
Readmitted and earned course credit at a public community college	F94	(Active)
Transferred to a university	Sp95	(1994 or any subsequent catalog)

EXAMPLE B:

Admitted and earned course credit at a public community college or university	F92	(Active)
Nonattendance	Sp93	(Inactive)
Readmitted and earned course credit at a public community college	Su93	(Active)
Nonattendance	F93, Sp94	(Inactive)
Transferred to a university	F94	(1992 or any subsequent catalog)

*Students are not obligated to enroll and earn course credit during summer terms, but summer enrollment may be used to maintain continuous enrollment status.

Summer Readmission

3. Students admitted or readmitted to a public Arizona community college or university during a summer term must follow the requirements of the catalog in effect the following fall semester or of any single catalog in effect during subsequent terms of continuous enrollment.

EXAMPLE:

Admitted and earned course credit at a public community college or university	Su94	(Active)
Continued at a public community college	F94, Sp95	(Active)
Nonattendance	F95	(Inactive)
Readmitted and earned course credit at a public community college	Sp96	(Active)
Transferred to a university	Su96	(1994 or any subsequent catalog)

Institutional Transfer

4. Students transferring among Arizona public higher education institutions must meet the admission requirements, residency requirements, and all curricular and academic requirements of the degree-granting institution.

TEACHER EDUCATION: MARICOPA COMMUNITY COLLEGE DISTRICT-WIDE OFFERINGS

In direct response to the ever growing need for highly qualified P-12 teachers and in support of the many communities it serves, the Maricopa Community College District has made a strong commitment to contributing to the recruitment and training of early childhood, elementary, secondary, and special education school teachers. With quality curriculum and excellent instruction as the primary focus of its faculty, the Maricopa colleges are well positioned to provide state and national leadership in the quality and nature of instruction thus helping students to become excellent teachers through the offering of current and responsive teacher education course work.

The District also supports professional development for certified teachers through the offering of course work, seminars, workshops and specialized training. This includes Bilingual Education, Computer Science, English as a Second Language (ESL), Math Specialist, Middle School, Reading Specialist, and Structured English Immersion (SEI).

In support of this commitment, the Maricopa Community College District offers teacher education course work, degrees, and/or programs at all ten Maricopa Colleges.*

Teacher Education Options Available to Students

Instructional Aide/Associate/Paraprofessional Preparation

- **Associate in Arts in Elementary Education (AAEE):** designed for the student who plans to transfer to an Elementary Education program (also Special Education) at any partner institution and/or who plans to become a classroom instructional aide. The degree transfers as a block without loss of credit to Arizona's public universities. (Offered at all ten Maricopa Community Colleges)
- **Associate in Applied Science (AAS) in Teacher Assisting:** prepares students for employment as an assistant to the classroom teacher in grades K-12. It provides foundation work, which will allow the aide to pursue a higher degree in the field of education. (Offered at EMCC and GWCC)
- **Associate in Applied Science (AAS) in Instructional Assistance:** prepares students to work as instructional assistants. The program emphasizes the philosophical, cultural, and linguistic processes involved in teaching children. Students develop knowledge and skills required of the instructional assistant through a combination of courses in methodology and practicum experience. (Offered at MCC and PC)
- **Associate in Transfer Partnership (ATP) in K-12 Classroom Instructional Support:** designed for students planning on becoming an Instructional Associate/Paraprofessional in K-12. Transfers as a block without loss of credit to Charter Oak State College. (Offered at EMCC, MCC and RSC)
- **Certificate of Completion (CCL) in Instructional Assistance:** provides coursework which focuses on meeting the educational needs of learners. All Certificate Program requirements can be used toward completion of the Instructional Assistance AAS Program. (Offered at MCC and PC)

Elementary Education Teacher Preparation

- **Associate in Arts in Elementary Education (AAEE):** designed for the student who plans to transfer to an Elementary Education program (also Special Education) at any partner institution and/or who plans to become a classroom instructional aide. The degree transfers as a block without loss of credit to Arizona's public universities. (Offered at all ten Maricopa Community Colleges)
- **Associate in Transfer Partnership (ATP) in Elementary Education:** designed for students planning on becoming an Instructional Associate/Paraprofessional in K-12. Transfers as a block without loss of credit to Charter Oak State College. (Offered at EMCC, MCC and RSC)

- **Baccalaureate Partnership Program with Charter Oak State College:** designed for students in elementary education who will transfer to Charter Oak State College after completing 90 credits at the community college. (Offered at RSC)

Elementary and Special Education Teacher Preparation

- **Associate in Arts in Elementary Education (AAEE):** designed for the student who plans to transfer to an Elementary Education program (also Special Education) at any partner institution and/or who plans to become a classroom instructional aide. The degree transfers as a block without loss of credit to Arizona's public universities. (Offered at all ten Maricopa Community Colleges)
- **Urban Teacher Corps:** a teacher development program that supports urban classified school district employees in Phoenix to successfully complete a bachelor's degree in Education and return to their school districts as teachers. After completion of lower division courses, UTC participants transfer to the initial Teacher Certification program at Arizona State University, Tempe. (Offered at PC)

Elementary, Secondary and Special Education Teacher Preparation

- **Aztec/Education:** housed in the Office of Program Articulation, this program assists and supports students throughout the first two years of their bachelor's degree in elementary, secondary, or special education. (Offered at GCC)
- **Dynamic Learning Teacher Education Program:** a four-semester cohort model designed to prepare future teachers to transform inner city schools. It is based on current research on teaching and learning and utilizes a team-taught interdisciplinary curriculum with strong partnerships with community schools and Arizona State University, Tempe. (Offered at SMCC)
- **inspire.teach:** a program that supports and encourages the choice of teaching as a profession. It reflects a commitment among secondary, community college, and university partners to inspire students from under-represented groups to explore, pursue and excel in teaching careers. (Offered at EMCC)
- **The Teacher Connection:** designed to identify, connect, and support individuals as they work toward careers in teaching. It reflects a commitment among Cave Creek Unified School District, Paradise Valley Unified School District, Paradise Valley community College, and ASU West's College of Education to inspire a diverse population of students to explore, pursue, and excel in teaching careers. (Offered at PVCC)
- **Teaching and Learning Communities (TLC) Education Program:** a student support program structured in a four-semester plan with courses selected to enhance students' knowledge of teaching as a career and to prepare for certification. (Offered at MCC)
- **Teachers Today and Tomorrow (T3):** this two-semester interdisciplinary learning community combines English, Education and Technology. After two semesters, education courses along with technology courses designed for teacher education majors complement the general education courses required for university transfer. (Offered at CGCC, Williams Campus)
- **General Studies and Subject Matter Courses:** designed to fulfill lower division general education requirements for students planning to transfer to public or private community colleges or universities. (Offered at all Maricopa Community Colleges)
- **Post Baccalaureate Teacher Prep Programs:** prepares students with a baccalaureate degree to become a certified Elementary (K-8), Secondary (7-12), or Special Education (K-12) teacher. The programs are approved by the Arizona Department of Education. [All programs offered online at RSC; elementary (K-8) offered on campus at SCC]

Teacher Education: MCCCDC Offerings

Master's Degree Partnerships for Students who complete the Rio Salado College and Scottsdale Community College Teacher Prep Programs

- **Master's Degree Partnership with North Central University:** 18 credits of the post baccalaureate teacher prep program can be applied toward the 36 credits required for an online MS in Education Degree. (Offered at RSC)
- **Master's Degree Partnership with Plymouth State University:** 18 credits of the post baccalaureate teacher prep program can apply toward the 33 credits required for an online MS in Education Degree. (Offered at RSC, SCC)
- **Master's Degree Partnership with Walden University:** Up to 12 credits of the post baccalaureate teacher prep program can apply toward the 30 credits required for an online MS in Education Degree. (Offered at RSC, SCC)

Professional Development for Certified Teachers

- **Certificate of Completion (CCL) in Bilingual Endorsement:** designed for certified teachers pursuing bilingual endorsement. Includes all coursework required for state issued Bilingual Endorsement as specified by the Arizona Department of Education. Valid Arizona teaching certificate is required for state endorsement. (Offered at MCC, PC)
- **Certificate of Completion (CCL) in English as a Second Language (ESL) Endorsement:** designed for certified teachers pursuing ESL endorsement. Includes all coursework required for state issued English as a Second Language Endorsement as specified by the Arizona Department of Education. Valid Arizona teaching certificate is required for state endorsement. (Offered at MCC, PC)
- **Certificate of Completion (CCL) in Reading Specialist Endorsement:** qualifies certified teachers for Reading Specialist Endorsement as specified by the Arizona Department of Education. Includes all coursework required for those with valid Arizona teaching certificates to qualify for the Reading Specialist Endorsement in Arizona. (Offered at MCC, PC)
- **Professional Development Endorsement Courses for K-12 Teachers:** courses have been designed and are accepted by the Arizona Department of Education and lead to endorsements in Computer Science, Structured English Immersion (SEI), English as a Second Language (ESL), Math Specialist, Reading Specialist, and Middle School. (All courses offered online at RSC; MCC offers Reading and ESL on campus)

*NOTE:

- (1) Refer to specific college catalog for degree, program and course information.
- (2) Students are strongly encouraged to seek academic advisement prior to enrolling.

Early Childhood Education and Family Studies Options Available to Students

It is important to note that there is a wide range of difference in educational requirements for early childhood education teachers both locally and nationally. Given this, it is important that you check with the contact person at the college you are planning to attend prior to enrolling in coursework.

Associate Degrees

- **Associate in Applied Science (AAS) in Early Childhood Education:** prepares individuals to work with children in early childhood programs, with a specialization in either center-based, family childcare, or administration of early childhood programs. Courses are scheduled to accommodate those who are already working in the field. (Offered at GCC)
- **Associate in Applied Science (AAS) in Early Childhood Education:** designed to prepare students for employment as early childhood teachers in a variety of educational programs. Students learn effective teaching skills as they apply developmentally appropriate early childhood educational theory in the classroom setting. Courses have been selected with a focus on developing an educational career ladder. (Offered at PVCC)
- **Associate in Applied Science (AAS) in Early Childhood Development:** designed to meet the needs of individuals who are interested in working in early childhood. The program emphasizes working with multi-linguistic and multi-cultural children. Upon completion students will be equipped to work effectively with children and families in both school and home environments and also initiate upward career movement or improve existing skills. (Offered at SMCC)
- **Associate in Applied Science (AAS) in Early Childhood Development:** prepares individuals to assume entry-level positions within nursery schools, preschools and day care centers. (Offered at SCC)
- **Associate in Applied Science (AAS) in Child Development:** includes a sequence of interactive classes and a variety of field experiences. Unique student teaching opportunities are offered in the Evelyn H. Warren Child Development Lab, a multi-age preschool that is accredited by the National Association for the Education of Young Children. (Offered at MCC)
- **Associate in Applied Science (AAS) in Family Life Education:** prepares individuals to enter the family life education, human development, or child and family organizations field at the paraprofessional level. (Offered at GCC, MCC, SCC)
- **Associate in Applied Science (AAS) in Family Resources:** prepares students to work with families, identify needs, and acquire resources that strengthen family functioning. Includes skills in assessing and controlling needed resources, decision making, problem solving, communication, parenting, and child development education. (Offered at PC)
- **Associate in Transfer Partnership (ATP) in Early Childhood Education:** prepares students to work with families, identify needs, and acquire resources that strengthen family functioning. Includes skills in assessing and controlling needed resources, decision making, problem solving, communication, parenting, and child development education. (Offered at PC)

Teacher Education: MCCCDC Offerings

Certificates of Completion

- **Certificate of Completion (CCL) in Early Childhood Education:** designed for those who are interested in studying and working with young children. It prepares individuals to work with children in early child programs, with a specialization in either center-based or family child care. Courses are scheduled to accommodate those who are already working in the field. (Offered at GCC)
- **Certificate of Completion (CCL) in Early Childhood Education:** designed to prepare students for employment as early childhood teachers in a variety of educational programs. Students learn effective teaching skills as they apply developmentally appropriate early childhood educational theory in the classroom setting. Courses have been selected with a focus on developing an educational career ladder. (Offered at PVCC)
- **Certificate of Completion (CCL) in Early Childhood Development:** prepares individuals to assume entry-level positions within nursery schools, preschools and day care centers. (Offered at SCC)
- **Certificate of Completion (CCL) in Early Childhood Development:** designed to meet the needs of individuals who are interested in working in early childhood. Emphasis on working with multi-linguistic and multi-cultural children. Upon completion students will be equipped to work effectively with children and families in both school and home environments and also initiate upward career movement or improve existing skills. (Offered at SMCC)
- **Certificate of Completion (CCL) in Child Care:** designed to increase understanding of the education and care of young children. (Offered at MCC)
- **Certificate of Completion (CCL) in Classroom Management for Infants, Toddlers, and Preschool:** designed for understanding infants, toddlers and preschool children and managing their early childhood classroom settings. Focuses on key areas related to early childhood. (Offered at PC)
- **Certificate of Completion (CCL) in Family Support:** designed to enhance the education and career of individuals interested in working with families or in agencies that provide services to families, or those who are presently involved with families or their supporting agencies. (Offered at PC)
- **Certificate of Completion (CCL) in Infant/Toddler Development:** prepares individuals to serve children from birth through age three years and their families. (Offered at SCC)
- **Certificate of Completion (CCL) in Parent Education:** prepares individuals to enter the family life education with a focus on parent education. (Offered at GCC, MCC, SCC)
- **Certificate of Completion (CCL) in Adolescent Studies:** designed for individuals preparing to work for those who are employed in professions that require interaction with adolescents and/or adolescent-related issues such as school personnel, parents, health educators, etc. (Offered at PC)

***NOTE:**

- (1) Refer to specific college catalog for degree, program and course information.
- (2) Students are strongly encouraged to seek academic advisement prior to enrolling.

College Contact Information

Chandler-Gilbert Community College (CGCC)

Teacher Education: Sharon Fagan (Pecos Campus)
sharon.fagan@cgmail.maricopa.edu 480-732-7124
Dr. Brenda Larson (Williams Campus)
brenda.larson@cgmail.maricopa.edu 480-988-8804

Estrella Mountain Community College (EMCC)

Teacher Education: Marsha Carlen
marsha.carlen@emcmail.maricopa.edu 623-935-8479
Early Childhood Education: Marsha Carlen
marsha.carlen@emcmail.maricopa.edu 623-935-8479

GateWay Community College (GWCC)

Teacher Education: Elizabeth Skinner 602-286-8736

Glendale Community College (GCC)

Teacher Education: Nancy Oreshack
nancy.oreshack@gmail.maricopa.edu 623-845-3265
Early Childhood Education: Dr. Carlos Nunez 623-845-3178

Mesa Community College (MCC)

Teacher Education:
Transfer Services 480-461-7452 or 480-654-7600
Dr. Richard Malena (Red Mountain Campus) 480-461-7890
richard.malena@mccmail.maricopa.edu
Early Childhood Education:
Dr. Diana Abel diana.abel@mccmail.maricopa.edu 480-461-7305 or
Dr. Christine Osgood osgood@mail.mc.maricopa.edu 480-461-7938

Paradise Valley Community College (PVCC)

Teacher Education: Dr. Barbara Carlile
barbara.carlile@pvmail.maricopa.edu 602-787-6659
Early Childhood Education: Christie Colunga
christie.colunga@pvmail.maricopa.edu 602-787-7731

Phoenix College (PC)

Teacher Education: Ofelia Canez 602-285-7657
Early Childhood Education: Alverta McKenzie 602-285-7292

Rio Salado College (RSC)

Teacher Education:
academic.advisement@email.rio.maricopa.edu 480-517-8580
Early Childhood Education:
academic.advisement@email.rio.maricopa.edu 480-517-8580

Scottsdale Community College (SCC)

Teacher Education: Dr. Bobbie Sferra 480-423-6217
Early Childhood Education: Dr. Rosanne Dlugosz 480-423-6204

South Mountain Community College (SMCC)

Teacher Education:
Dr. Eufemia Amabisca
eufemia.amabisca@smccmail.maricopa.edu 602-243-8019
Dr. Yvonne Montiel
yvonne.montiel@smccmail.maricopa.edu 602-243-8023
Early Childhood Education: Joy Mills 480-305-5783

Continued next page...

Teacher Education: MCCC D Offerings

College of Attendance

Completion of teacher education course work for the various degrees, certificates and programs available can be met through the completion of teacher education course work taken at any Maricopa Community College. Refer to specific college catalogs and course schedules for available offerings.

Common College Requirements for Students Enrolled in Teacher Education Course Work

Students taking Teacher Education Courses are expected to:

- Receive a grade of C or better in all course work.
- Participate in site-based practicums, field experiences or service learning. This may include observation, tutoring, and some basic teaching. Work with the person identified by the college to coordinate the site-based school placements.
- Be fingerprinted, if required. Some school districts require this before students are allowed to participate in a site-based school experience. The cost of fingerprinting is the sole responsibility of the student. Contact each individual college for specific information.
- Pay course fees. Refer to specific college course schedules and catalogs.

University Transfer Students

Students planning to transfer to a college/university other than Arizona State University (ASU), University of Arizona (UofA), or Northern Arizona University (NAU) to obtain a teacher education degree may also take their prerequisite course work at any Maricopa College. For information on transferability of course work that meets the universities requirements for admission into their teacher preparation baccalaureate programs, students must contact an adviser at that college/university.

Teacher Education Scholarship Availability

The National Center for Teacher Education (NCTE) has created scholarships for teacher education students attending the Maricopa Community Colleges. Currently there are four (4) \$500 scholarship awards available for each of the ten Maricopa colleges. Visit <http://www.maricopa.edu/academic/teachered/scholarship.html> for additional information.

The National Association of Community College Teacher Education Programs (NACCTEP) has a national scholarship program. The purpose the NACCTEP National Scholarship Program is to provide financial assistance to community college students who are studying to become teachers. This scholarship is promoted through the National Association of Community College Teacher Education Programs and is facilitated by the National Center for Teacher Education. Awards are \$1,000 over the course of two semesters and will be made available through college financial aid institutions. Visit <http://www.nacctep.org/Scholarship/05-06scholarship.php> for additional information.

The Professional Career Pathway Project (PCPP) is sponsored by the Arizona Department of Economic Security Child Care Administration. This program offers Family Child Care and Center-based caregivers the opportunity to apply for funding to cover the cost of the tuition/fees for college coursework. The PCPP offers students a seamless pathway to meet the requirements for the Child Development Associate (CDA) Credential, the National Association for Family Child Care (NAFCC) Accreditation, and the Certificate of Completion. (EMCC, GCC, MCC, PVCC, SCC, SMCC)

Early Childhood Education Scholarship Opportunities information is available at each college. Make contact with the designated college Early Childhood contact person directly. Scholarship opportunities vary with each program.

OCCUPATIONAL PROGRAMS OF MCCCC

Colleges:

CG	Chandler/Gilbert Community College
EM	Estrella Mountain Community College
GC	Glendale Community College
GW	GateWay Community College
MC	Mesa Community College
PC	Phoenix College
PV	Paradise Valley Community College
RS	Rio Salado College
SC	Scottsdale Community College
SM	South Mountain Community College

Agriculture

Agribusiness Sales and Service

Pest Management Aide MC

Agricultural Production and Management

Agribusiness GC, MC

(See also Agribusiness Sales and Service and Horticulture sections)

Ranch and Livestock Management Aide MC

Ranch and Livestock Management Specialist MC

Urban Horticulture GC, MC

(See also Horticulture section)

Equine Training and Management

Equine Science SC

Veterinary Technology/Animal Health MC

Horticulture

Landscape Aide MC

Landscape Design and Installation GC

Landscape Management GC

Landscape Specialist MC

Nursery Operations GC

(See also Agricultural Production and Management section)

Business

Accounting

Accounting PC

Accounting-Specialized Para-Professional PV

Bookkeeping SC

Bookkeeping/Accounting GW

Microcomputer Accounting GW, PC, PV

(See also Business Administration section)

Paraprofessional Accounting GC

Business Administration

Business MC

Business (FASTRACK) SC

Business (Tracks: Accounting, Management, Marketing)

Retail Management and Marketing, or Small Business Management SC

General Business CG, GC, GW, PC, PV

(See also Management and Finance section)

International Trade GW, MC, PV

Computer Science

Computer Applications Technology EM

Computer Applications: Microsoft Office Specialist/Advanced MC

Computer Applications: Microsoft Office Specialist/Basic MC

Computer Hardware and Desktop Support CG, EM, GW, MC, PC, SC

Computer Hardware and Network Support SC

Computer Information Systems GC, MC, PC, PV, SC, SM

Computer Networking Technology PV

Computer Programming & Analysis SM

Computer Systems Maintenance PV

Computer Technology RS

Computer Usage and Applications RS

Database Development SC

Desktop Publishing EM

Education Technology GW

Geographic Information Systems MC

Helpdesk Specialist GC

Information Assurance MC

Information Security CG, EM, GC, GW, PC, SM

Information Security Administration CG, EM, GC, GW, SM

Information Security Technology CG, EM, GC, GW, PC, SM

Information Technology CG, SM

Information Security Wireless Networks CG, EM, GC, GW, SM

Internet Design and Development SM

Linux Associate CG, EM, GC, GW, MC, SM

Linux Networking Administration CG, EM, GC, GW, MC, SM

Linux Professional CG, EM, GC, GW, MC, PV, SM

Linux Systems Administration SM

Microcomputer Applications GC

(See also Office Occupations section)

Microcomputer Applications: Office Specialist/Core Level CG

(See also Office Occupations section)

Microcomputer Applications: Office Specialist/Expert Level CG

(See also Office Occupations section)

Microcomputer Business Applications CG, GC

(See also Office Occupations section)

Microsoft Applications Specialist SM

Microsoft Database Administration CG

Microsoft Desktop Support Technology CG, EM, GC, GW, MC, PV, SC

Microsoft Networking Technology CG, EM, GC, GW, PV, SC

Microsoft Product Specialist CG, EM, GC, GW, PV, SC

Microsoft Applications Development CG, GW, MC, PV, SC

Microsoft Systems Administration CG, EM, GC, GW, PV, SC, SM

Microsoft Systems Engineer CG, EM, GC, GW, PV, SC

Network Administration SC

Network Administration:

Cisco Network Associate MC

Cisco Network Professional MC

Microsoft Windows NT MC

Microsoft Windows MC

Novell MC

UNIX-Solaris MC

Network Professional RS

Network Security MC

Networking RS

Networking Administration: Cisco CG, EM, GC, GW, SM

Networking System Administration MC

Networking Technology: Cisco CG, EM, GC, GW, SM

Oracle Database Administrator EM, GC

Oracle Database Operations CG, EM

Personal Computer Applications SC

Programming RS

Programming and System Analysis CG, EM, GC, GW, MC, PC, PV, SC, SM

Programming Methodology MC

Software Development SC

Technology Helpdesk Support RS

Technology Troubleshooting and A+ Preparation RS

Web Design GC, GW, PV

Web Design SC

Web Designer MC

Web Designer Associate MC

Web Developer EM, GC, GW, MC, PC, PV

Web Development SC

Web Master RS

Web Server Administrator MC

Web Technology MC

Finance

Banking and Finance PC

General Business - Insurance Level I PC

General Business - Insurance Level II PC

General Business - Insurance PC

Home Inspection MC

Home Inspection: Basic Inspector PC

Home Inspection: Business Owner Operator Inspector PC

Real Estate GC, MC

Real Estate: Prelicense PC

Management

Business Management SM

Credit Union Management PC

General Business PC

Management MC, PC, SC

Management I and II PC

Middle Management GC, PV

Military Leadership RS

Project Management MC

Public Administration RS

Public Administration: Legal Services RS

Public Relations GC

(See also Middle Management section)

Retail Management CG, GC, GW, EM, MC, PC, PV, RS, SC, SM

Retail Sales Manager MC

Small Business MC

Small Business Entrepreneurship GC, SM

Occupational Programs of MCCC

Small Business Management	EM	Clinical Laboratory Sciences	PC
Supervision	GC	Community Health Advocate: Diabetes	MC, SC
Supervision and Management I and II	SM	Computed Tomography	GW
Supply Chain and Operations Management	GW	Developmental Disabilities Specialist	CG, GC
Tribal Development	SC	Diagnostic Medical Ultrasound	GW
Marketing		Direct Care Practice	MC
Marketing	MC, PC, SC	Donor Phlebotomy	PC
Marketing I and II	PC	Electroneurodiagnostics	GW
Salesmanship	MC	Health Information	PC
Media Technology		Health Information Technology	PC
Digital Photography	PC	Health Services Management	GW
Media Arts: Computer Art/Illustration	CG, MC, PC, PV	Health Unit Coordinating	GW
Media Arts: Desktop Publishing	MC, PC	Histology Technician	PC
Media Arts: Digital Animation	MC, PC	Hospital Central Service Technology	GW
Media Arts: Digital Imaging	CG, MC, PC	Laboratory Assisting	PC
Media Arts: Web Page Design	MC, PC	Medical Assisting	PC
Motion Picture/Television Production	SC	Medical Billing	PC
Broadcast Production	SC	Medical Coding: Hospital-Based	PC
Editing	SC	Medical Coding: Physician Based	PC
Film Analysis and Criticism	SC	Medical Front Office	PC
Film Production	SC	Medical Radiography	GW
Screenwriting	SC	Medical Transcription	GW
Multimedia	GC	Nuclear Medicine Technology	GW
Multimedia Imaging and Animation	GC	Patient Care Technician	PC
Multimedia Web Design	GC	Perioperative Nursing	GW
Video Production Technology	GC	Phlebotomy	PC
Middle Management		Physical Therapist Assisting	GW
Public Relations	MC	Radiation Therapy	GW
<i>(See also Management section)</i>		Respiratory Care	GW
Office Occupations		Surgical Technologist First Assisting	GW
Administrative Office Coordinator	GC	Surgical Technology	GW
Administrative Office Professional	PV	Dental	
Call Center Supervision	GC	Clinical Dental Assisting	RS
Computer Applications	PC	Dental Assisting	MC, PC
Computer Software Applications	PV	Dental Hygiene	MC, PC, RS
Customer Service/Information Professional	PV	Dental Office Management	PC
Data Entry Clerk	EM, GC	Emergency Medical Technology	
General Office Secretary	EM, GC	Advanced Emergency Medical Technology (Paramedic)	GC, PC, PV, SC
Paralegal Studies	PC	Basic Emergency Medical Technology	GC, MC, PC, PV, SC
Legal Secretarial	PC	Community Emergency Response Team (CERT): Level I	PC
Medical Office Support (Basic Clerical & Basic Transcription)	PC	Emergency Communications and Deployment	PC
Office Automation Systems	GW, SC, SM	Intermediate Emergency Medical Technology	MC, PC
Office Coordinator	GC	<i>(See also Allied Health section)</i>	
Office Fundamentals	SC	Paramedicine	MC
Technology Support Analyst	MC	Secondary Basic Emergency Medical Technology	PC
Office Specialist: Computer Applications	GW	Nursing	
Office Support	GW, PC	Fast Track Practical Nursing	GW
Office Support I and II	PC	Nursing	GC, GW, MC, PC, PV, RS, SC
Realtime Reporting (Scoping, Broadcast Captioning, CART or Judicial)	GW	Nurse Assisting	GC, GW, MC, PC, PV, RS, SC
Receptionist	EM, GC	Practical Nursing	GC, GW, MC, PC, PV, RS, SC
Word Processing	SC	Home Economics	
Total Quality Management		Early Childhood Education	
Automobile Insurance: Customer Service	RS	Adolescent Studies	PC
Automobile Policy: Customer Service	RS	Adolescent Development	GC, MC
Credit Card: Customer Service	RS	Adult Development and Aging	GC, MC
Credit Counseling: Customer Service	RS	Child Care Administration	PC
Digital Telecommunications: Customer Service	RS	Child/Family Organizations Management/Administration	GC, MC
Human Services - Assistance: Customer Service	RS	Classroom Mgmt. for Infants, Toddlers and Preschool Children	PC
Human Services - Long Term Care: Customer Service	RS	Early Care and Education	MC
Human Services - Specialist: Customer Service	RS	Early Care Specialist	MC
Insurance - Customer Service	RS	Early Childhood Development	SC, SM
Insurance Claims and Losses: Customer Service	RS	Early Childhood Education	GC, PV
Organizational Leadership	CG, EM, GW, MC, PV, RS	Family Life Education	GC, MC, SC
Organizational Management	CG, EM, GW, MC, PV, RS	Family Resources	PC
Pharmacy Benefits Management: Customer Service	RS	Family Support	PC
Pharmacy: Customer Service	RS	Infant/Toddler Development	SC
Quality Customer Service	GW, RS	Parent Education	GC, MC, SC
Quality Process Leadership	GW, RS	Education	
Telecommunications: Customer Service	RS	Bilingual Endorsement	MC, PC
Total Quality Management	EM	English as a Second Language (ESL) Endorsement	MC, PC
Travel Agency: Customer Service	RS	Instructional Assistance	MC, PC
Utilities Customer Service	RS	Reading Specialist Endorsement	MC, PC
Health Occupations		Teacher Assisting	EM, GW
Allied Health		Family and Consumer Science	
Advanced Behavioral Health Sciences/Recovery	SM	Nutrition for Fitness and Wellness	GC, MC
Advanced Behavioral Health Sciences	SM	Food and Nutrition	
Basic Behavioral Health	SM	Advanced Professional Culinary Arts	SC

Occupational Programs of MCCC

Basic Culinary Studies	EM
Commercial Food Preparation	PC
Culinary Studies	EM, PC, MC

(See also Hospitality section)

Dietetic Technology	CG, PV
Food Service Administration	PC
Professional Food and Beverage Service	PC

Home Economics

Advanced Interior Design	PC
Apparel Construction	PC
Costume Design and Production	MC
Fashion Design	PC
Fashion Design Level I and II	PC
Fashion Illustration Level I, II and III	PC
Home Furnishing and Materials	GC, MC, PC
Interior Design	MC, PC, SC
Interior Design: Advanced	MC
Interior Design: Professional Level	SC
Pattern Design Level I and II	PC

Merchandising

Apparel Merchandising & Design	MC
Fashion Merchandising	PC
Image Consultant	MC

Service Occupations

Administration of Justice

Administration of Justice	EM, GC, PC
Administration of Justice - Comprehensive	PC
Administration of Justice - Fundamentals	PC
Administration of Justice Studies	CG, MC, SC
Advanced Corrections	RS
Basic Corrections	RS
Corrections	RS
Crime and Accident Scene Photography	PC
Crime and Intelligence Analysis	CG
Crime Scene Investigation	SC
Crime Scene Technology	SC
Cyber Forensics Technician	MC
Detention Services	RS
Evidence Technology	CG, PC
Fingerprint Classification and Identification	PC
Forensic Investigation	MC
Forensic Science: Crime Lab	SC
Global Citizenship	MC
Homeland Security	CG
Information Assurance	MC
Information Security Forensics	EM, GC, GW, SM
Judicial Studies	MC
Justice Agencies Support	MC, PC
Justice Agencies Support Level I and II	MC, PC
Justice Studies	CG, SC
Law Enforcement	SC
Law Enforcement Field Training	RS
Law Enforcement Investigator	GC
Law Enforcement Technology	RS
Law Enforcement Training Academy	CG, GC
Police Academy Preparation: Level I	SC
Police Science	MC, SC
Police Supervision	GC
Public Safety Technology	RS
Victimology	MC

Fire Science

Basic Firefighter	MC, PV
Driver Operator	MC
Emergency Management	GC, GW, MC, PV, SM
Fire Academy	GC, SC
Fire Officer I	MC
Fire Science	GC, PC, PV, RS
Fire Science Technology	GC, MC, PV, SC
Recruit Firefighters	GC

Hospitality

Advanced Professional Culinary Arts	SC
Airline Operations	RS
Airline Operations: Ground Operations	RS
Airline Operations: Initial Flight Attendant	RS
Airline Operations: Passenger Services	RS
Airline Operations: Reservations	RS
Airline Operations: Vacations	RS
Culinary Arts	SC

(See also Food and Nutrition section)

Hospitality and Tourism/Golf Management	SC
Hospitality and Tourism/Hotel Management	SC
Hospitality and Tourism/Restaurant Management	SC
Hospitality/Hotel Management	EM

Library Media Technology

Library Information Technician: Basic/Advanced	MC
--	----

Mortuary Science

Mortuary Science	MC
------------------------	----

Music

Audio Production Technologies	GC, MC, PC, PV, SC
Dance Technology	SC
Music Business	CG, GC, GW, MC, PC, PV, SC

Parks, Recreation, Leisure and Fitness Studies

Recreational Resources and Facilities Management	PC
Recreational Resources and Facilities Management:	
Equipment Maintenance and Repair	PC
Horticulture	PC
Pesticides	PC
Pro Shop Management	PC
Turf and Irrigation	PC
Recreation Management	MC, PC, SC

Health and Physical Education/Fitness

Group Fitness Instructor	GC, MC
Personal Trainer	GC, MC
Strength & Conditioning Personal Trainer ..	CG, Em, GC, GW, MC, PV, SC, SM
Teaching, Healing, Meditation and Stress Management	PV
Therapeutic Massage	CG, PC
Yoga Instruction	SC

Social Sciences

Chemical Dependency	RS
Chemical Dependency: Level I and II	RS
Clinical Research Coordinating	GW
Deaf Studies	PC
Interpreter Preparation	PC
Professional Addictions Counseling	RS

Social Services

Assisted Living:	PC
Fiduciary Practices	PC
Gerontology	PC
Human Services	GC
Social Service Aide (Basic & Intermediate)	PC

Technology and Trade Industrial

Air Conditioning and Refrigeration

Air Conditioning/Refrigeration/Facilities	GW
---	----

Apprenticeship Related Instruction

Bricklaying	GW
Carpentry	GW
Construction Management	GW, PC
Construction Trades: Carpentry, Millwright, Painting or Sheet Metal	GW
Electricity	GW
Heat and Frost Insulation	GW
Ironworking	GW
Millwright	GW
Painting	GW
Pipefitter-Refrigeration	GW
Plumbing	GW
Power Plant Technology	EM, GC, GW
Roofing	GW
Sheet Metal	GW
Steamfitting	GW

Aviation and Aeronautics

Aircraft Construction Technology	CG
Aircraft Maintenance Technology	CG
Aircraft Maintenance Technology (Part 147)	CG
Airframe Maintenance (Part 147)	CG
Airway Science Technology, Flight Emphasis	CG
Aviation Electronics Maintenance Technology	CG
Avionics Technology	CG
Composite Technology	CG
Flight Technology	CG
Powerplant Maintenance (Part 147)	CG
Sheet Metal Structures Technology	CG

Automotive Technology

Air Conditioning	MC
Air Conditioning and Electrical Accessories	GW

Occupational Programs of MCCC

Automotive Chassis	GC	Wastewater Treatment	GW
Automotive Drive Trains	GW	Water Distribution and Collection	GW
Automotive Electrical Systems	MC	Water Purification Technology	GW
Automotive Engines and Drive Trains	GC	Water Technologies	GW
Automotive Engine Performance Diagnosis & Air Conditioning	GC	Water Treatment	GW
Automotive Performance Technology	MC	Manufacturing	
Automotive Suspension, Steering and Brakes	GW	Aerospace Manufacturing Technology	GW
Automotive Technology	GC, GW	Automated Manufacturing Systems	CG
Brakes, Alignment, Suspension and Steering	MC	Manufacturing CNC	MC
Caterpillar Technician Training	MC	Manufacturing Engineering Technology	MC
Engine Performance and Diagnosis	GW, MC	Manufacturing Machining	MC
Transmissions and Power Trains	MC	Manufacturing Management	MC
Building and Construction		Manufacturing Technology	MC
Building Inspection	MC	Manufacturing Welding	MC
Building Safety and Construction Technology	PC	<i>(See also Welding Technology section)</i>	
Building Safety and Planning Technology	SC	Machinist	
Building Safety Technology	SC	Machinist, Tool and Die	MC
Carpentry	GW	Machinist, Tool and Die: Level I and II	MC
Civil Engineering Technology	PC	Tractor-Trailer Driving	GC
Home Improvement Retail Operations (Flooring, Kitchen or Millworks) ...	GW	Welding Technology	
Plan Review	MC	Welding	PC
Planning and Development Technology	SC	Welding Certification	MC
Pre-Contractor Licensing	MC	<i>(See also Manufacturing section)</i>	
Commercial Art/Advertising Art		Welding Technology	MC
Computer Graphic Design	GC, PC		
<i>(See also Media Technology section)</i>			
Drafting Technology			
CAD Technology	GC		
Architectural CADD Level III	MC		
Architectural Detailing CADD Level III	MC		
Architectural Drafting	PC		
Architectural Technology	SC		
Architecture	MC		
Basic CAD	GC		
CAD Application	GC		
CAD-Based Design Documentation	GC		
Civil CAD Technology	GC		
Commercial Drafting CADD Level II	MC		
Computer Aided Design/Drafting CADD Level I	MC		
Computer Aided Drafting	MC, PC		
Construction	MC		
Construction Drafting I, II and III	MC		
Construction Drafting CADD Level III	MC		
Electro/Mechanical Drafting	MC		
Graphic Design	SC		
Journalism	MC		
Journalism	CG, GC, PC, PV, SC, SM		
Manufacturing Design Technology	GC		
Manufacturing Productivity	GW		
Mechanical Drafting	MC		
Micro Circuit Mask Design	MC		
Microcomputer Servicing	GC		
Residential Drafting CADD Level II	MC		
Surveying and Civil Drafting CADD Level II	MC		
Electronics/Electrical Technology			
Cable Telecommunications	SM		
Computer and Networking Technology	GC		
Electric Utility Technology	CG		
Electrical Technology	GW		
Electromechanical Automation Technology	MC		
Electronics Engineering Technology	MC		
Electronics Manufacturing Technology	GC		
Electronics Technology	MC		
Industrial Operations Technology	EM, GW		
Local Area Networks Servicing	GC		
Telecommunications Technology: General	SM		
Telecommunications Technology: Networking	SM		
Engineering			
Civil Engineering Technology	PC		
Surveying Technology	PC		
Environmental Technology			
Biotechnology	MC		
Biotechnology and Molecular Biosciences	GC		
Environmental Health and Safety Technology	PV		
Hazardous Materials Response	PC		
Hydrologic Studies	GW		
Occupational Safety and Health Technology	GW		
Safety, Health and Environmental Studies	PV		

Wastewater Treatment	GW
Water Distribution and Collection	GW
Water Purification Technology	GW
Water Technologies	GW
Water Treatment	GW

Manufacturing

Aerospace Manufacturing Technology	GW
Automated Manufacturing Systems	CG
Manufacturing CNC	MC
Manufacturing Engineering Technology	MC
Manufacturing Machining	MC
Manufacturing Management	MC
Manufacturing Technology	MC
Manufacturing Welding	MC

(See also Welding Technology section)

Machinist

Machinist, Tool and Die	MC
Machinist, Tool and Die: Level I and II	MC
Tractor-Trailer Driving	GC

Welding Technology

Welding	PC
Welding Certification	MC

(See also Manufacturing section)

Welding Technology	MC
--------------------------	----

Maricopa Skill Center Areas/Programs/Certificates

The Maricopa Skill Center (MSC), a division of GateWay Community College, offers entry-level courses and programs for hands-on job training at 1245 East Buckeye Road, Phoenix, AZ. The more than 150 noncredit Maricopa Skill Center certificates are open-entry/open-exit and self-paced (with the exception of nursing).

Auto Body

Computer Technology Programs

Accounting
Administrative Assistant
Banking/Retail
Computer Aided Drafting
Customer Service
Graphic Communications
Information Processor
Repair/Networking
Specialized/Individual Courses
Travel

Facilities Maintenance

Health Care Services

Introduction to Culinary Arts

Machine Trades

Meat Cutting

Printing Trades

Welding

SouthWest Skill Center at EMCC Certificates

The SouthWest Skill Center at Estrella Mountain Community College, located at 3000 North Dysart Road, Avondale, offers entry-level courses and programs for hands-on job training. The programs are listed below and reference any certificate issued by that program.

Business Technology Occupation (Certificate Programs)

Administrative Secretary
Office Assistant w/Microsoft Office Suite
General office Secretary

Medical Assistant Program(Certificate Programs)

Medical Assistance Front Office/Back Office
Medical Assistance Front Office
Medical Assistance Back Office
Phlebotomy (beginning 7/1/2006)

Nursing Programs (Certificate Programs)

Nurse Assistant Program
Practical Nurse Program

SCOTTSDALE COMMUNITY COLLEGE PROGRAMS

ACCOUNTING

ACC

Business Division Office AP 237A (480) 423-6253

CERTIFICATE OF COMPLETION IN BOOKKEEPING: 27 credits

Students can earn a Certificate of Completion in Bookkeeping. Please see page 79 for detailed information on the required coursework.

AAS IN BUSINESS: 64-66 credits

Students can earn an AAS degree in Business with a specialization in Accounting. Please see page 78, "Business" for detailed information on the required coursework.

ADMINISTRATION OF JUSTICE STUDIES

AJS

Applied Sciences Division Office AP 237B (480) 423-6599
Program Director, Dr. John Kavanagh AP 248 (480) 423-6345

The Administration of Justice Studies program is designed to prepare men and women for careers in the fields of law enforcement, courts, corrections, crime scene processing, forensic science and related technical occupations. The program also provides practitioners within the criminal justice field the opportunity for continuing education and growth and development, or the background to continue their education at a four-year institution. Upon satisfactory completion of the outlined program, the students will receive an Associate in Applied Science degree in Administration of Justice Studies (see page 74).

In addition, an AAS degree is offered in Forensic Science: Crime Lab and Certificates of Completion are offered in Crime Scene Investigation, Crime Scene Technology, Justice Studies, and Police Academy Preparation (Level I).

CERTIFICATE OF COMPLETION IN CRIME SCENE INVESTIGATION: 16-17 CREDITS

The Certificate of Completion in Crime Scene Investigation is designed to develop knowledge and skills required to investigate and reconstruct crime scenes using scientific evidence and logical analysis. The program provides instruction in criminal investigation procedures, collection and preservation of physical and biological evidence, death investigation techniques, crime scene reconstruction methodology and presentation of testimony in court.

REQUIRED COURSES: 16-17 credits

AJS215	Criminalistics: Physical Evidence (3) OR	
AJS219	Crime Scene Technology: Physical Evidence (3) OR	
FOR105	Forensic Science: Physical Evidence (4)	3-4
AJS216	Criminalistics: Biological Evidence	3
AJS/FOR223	Forensic Pathology: Death Investigation	3
AJS243	Crime Scene Reconstruction	3
AJS275	Criminal Investigation	3
AJS290BN	Courtroom Testimony Seminar	1

Grade of "C" or better required for all courses in the Certificate of Completion in Crime Scene Investigation.

CERTIFICATE OF COMPLETION IN CRIME SCENE TECHNOLOGY: 16-17 CREDITS

The Certificate of Completion in Crime Scene Technology prepares students for careers as police or civilian crime scene technicians. The program provides comprehensive instruction in crime scene photography, fingerprint classification and processing, crime scene search techniques, chemical processing of evidence, packaging evidence, and related skills.

REQUIRED COURSES: 16-17 credits

AJS213	Evidence Technology/Fingerprints	3
AJS214	Evidence Technology/Photography	3
AJS216	Criminalistics: Biological Evidence	3
AJS215	Criminalistics: Physical Evidence (3) OR	
AJS219	Crime Scene Technology: Physical Evidence (3) OR	
FOR105	Forensic Science: Physical Evidence (4)	3-4
AJS242	Crime Scene Processing	3
AJS290BN	Courtroom Testimony Seminar	1

Grade of "C" or better required for all courses in the Certificate of Completion in Crime Scene Technology.

CERTIFICATE OF COMPLETION IN JUSTICE STUDIES: 15 CREDITS

The Certificate of Completion in Justice Studies will provide a core of courses for students who are interested in pursuing a career in Justice Studies but have previously received a degree in a different field of study. For students who are pursuing an AAS in Justice Studies, completion of the certificate will provide an area of specialization within their degree program.

REQUIRED COURSES: 15 credits

AJS119	Computer Applications in Criminal Justice	3
AJS217	Court Procedures	3
AJS230	The Police Function	3
AJS240	The Correction Function	3
AJS275	Criminal Investigation I	3

Grade of "C" or better required for all courses in the Certificate of Completion in Justice Studies.

CERTIFICATE OF COMPLETION IN POLICE ACADEMY PREPARATION, LEVEL I: 21 credits

The Police Academy Preparation Level I Certificate prepares students for careers as police officers.

REQUIRED COURSES: 21 credits

AJS101	Introduction to Criminal Justice	3
AJS109	Substantive Criminal Law	3
AJS212	Juvenile Justice Procedures	3
AJS230	The Police Function	3
AJS260	Procedural Criminal Law	3
AJS270	Community Relations	3
AJS275	Criminal Investigation I	3

Grade of "C" or better required for all courses in the Certificate of Completion in Police Academy Preparation, Level I.

Continued next page...

Scottsdale Community College Programs

AAS IN ADMINISTRATION OF JUSTICE STUDIES: 64-66 credits

REQUIRED COURSES: 27 credits

AJS101	Introduction to Criminal Justice	3
AJS109	Substantive Criminal Law	3
AJS201	Rules of Evidence	3
AJS210	Constitutional Law	3
AJS212	Juvenile Justice Procedures	3
AJS225	Criminology	3
AJS230	The Police Function	3
AJS240	The Correction Function	3
AJS260	Procedural Criminal Law	3

RESTRICTED ELECTIVES: 15 credits

Students may select any AJS and JUD courses listed in the college catalog including any AJS Certificates of Completion offered at Scottsdale Community College.

GENERAL EDUCATION (G.E.) REQUIREMENTS: 22-24 credits

CORE: 15-17 credits

First-Year Composition

Any approved G. E. course from the First-Year Composition area 6

Oral Communication

COM100 Introduction to Human Communication (3) OR
COM100AA(1), COM100AB(1) and COM100AC(1) OR
COM225 Public Speaking (3) 3

Critical Reading

CRE101 Critical and Evaluative Reading I (3) OR
equivalent as indicated by assessment. 3

Mathematics

Any approved G. E. course from the Mathematics area 3-5

DISTRIBUTION: 7 credits

Humanities and Fine Arts

AJS123 Ethics and the Administration of Justice 3

Natural Sciences

Any approved G. E. course from the Natural Sciences area 4

Social and Behavioral Sciences

Met by AJS101 in the Required Courses area 0

Grade of "C" or better required for all courses in the AAS in Administration of Justice Studies.

AAS IN FORENSIC SCIENCE: CRIME LAB: 60-65 credits

The Associate of Applied Science (AAS) in Forensic Science: Crime Lab prepares students for employment in forensic crime labs as assistants to crime lab criminalists. The program combines crime scene technology and criminal justice courses with general education courses and additional math, physics and chemistry courses.

REQUIRED COURSES: 33-34 credits

AJS101	Introduction to Criminal Justice	3
AJS123	Ethics and the Administration of Justice	3
AJS216	Criminalistics: Biological Evidence	3
AJS215	Criminalistics: Physical Evidence (3) OR	
AJS219	Crime Scene Technology: Physical Evidence (3)	3
AJS275	Criminal Investigation I	3
AJS290BN	Courtroom Testimony Seminar	1
PHY111	General Physics I	4
PHY112	General Physics II	4
CHM151	General Chemistry I	3
CHM151LL	General Chemistry I Laboratory	1
CHM154	General Chemistry II with Qualitative Analysis	3
CHM154LL	General Chemistry II w/Qualitative Analysis Laboratory	2

RESTRICTED ELECTIVES: 12-14 credits

CHM130	Fundamental Chemistry	3
CHM130LL	Fundamental Chemistry Laboratory	1
MAT120	Intermediate Algebra (5) OR	
MAT121	Intermediate Algebra (4) OR	
MAT122	Intermediate Algebra (3)	3-5
MAT150	College Algebra/Functions (5) OR	
MAT151	College Algebra/Functions (4) OR	
MAT152	College Algebra/Functions (3)	3-5
Any AJS, BIO, CHM, MAT or Foreign Language Courses		1-12

Recommended courses include AJS213, AJS214, AJS223, AJS242, BIO181/182, or CHM235/235LL.

GENERAL EDUCATION (G.E.) REQUIREMENTS: 15-17 credits

CORE: 15-17 credits

First-Year Composition

ENG101	First-Year Composition (3) OR	
ENG107	First-Year Composition for ESL (3) AND	
ENG102	First-Year Composition (3) OR	
ENG108	First-Year Composition for ESL (3)	6

Oral Communication

COM225 Public Speaking

Critical Reading

CRE101 Critical and Evaluative Reading I (3) OR
Equivalent by assessment. 3

Mathematics

MAT182 Trigonometry (3) OR
MAT187 Precalculus (5)

DISTRIBUTION: 0 credits

Humanities and Fine Arts

Met by AJS123 in Required Courses area 0

Natural Sciences

Met by PHY111 or PHY112 or CHM151/151LL or
CHM154/154LL in the Required Courses area

Social and Behavioral Sciences

Met by AJS101 in the Required Courses area 0

Grade of "C" or better required for all courses in the AAS in Forensic Science: Crime Lab.

Scottsdale Community College Programs

AMERICAN INDIAN ARTS INSTITUTE (AIAI) ART

Art Department Office AB 112 (480) 423-6344
 Fine Arts Division Office MB 139 (480) 423-6328

American Indian Arts Institute (AIAI) is a new program of study at SCC. Scottsdale Community College is located on the Salt River Pima-Maricopa Indian Community (SRPMIC) and wishes, in conjunction with the Community, to develop a year-round American Indian Cultural Center, with a focus on American Indian students and American Indian art instructors.

At present classes are being offered in Mono Silk Screen Print Making, mixed media and Art Beyond the Classroom. Art Beyond the Classroom is offered only in the summer months and travels to Australia and New Zealand for cultural arts exchange. SRPMIC students are given first consideration for filling classes. American Indian students of any other nation as well as non-American Indians of high school age or older are welcome to apply to any or all of our classes.

ARCHITECTURAL TECHNOLOGY ARC (Computer-Aided Drafting)

Applied Sciences Division Office AP 237B (480) 423-6599
 Program Director, Myron Brower AP 227 (480) 423-6229

Whether you have a specific interest in **Architectural Drafting** or a general interest in **Computer-Aided Drafting (CAD)**, SCC's **Architectural Technology Program** will serve your needs. Follow the Certificate or AAS degree options to prepare for drafting positions in Architecture, Interior Design, Consulting Engineering, Construction and Government offices ...or...pick and choose CAD, board drafting, print reading, construction or code classes to enhance specific skills.

NOTE: Effective Fall 2006, course prefixes, numbers, and titles for Architectural Technology/CAD have changed from the DFT prefix to ARC. Students currently enrolled in the program are urged to contact Myron Brower (480) 423-6229 or Michael Kuzmik (480) 423-6293 with questions or to set an appointment for advisement.

CERTIFICATE OF COMPLETION IN ARCHITECTURAL TECHNOLOGY: 30 credits

REQUIRED COURSES: 30 credits

ARC121	Introduction to Architectural Drafting : Manual	3
ARC141	Architectural CAD I: Introduction	3
ARC142	Architectural CAD II: Plans and Elevations	3
ARC146	Architectural Print Reading	3
ARC243	Architectural CAD III: Site Plans and Sections	3
ARC244	Architectural CAD IV: Structural Systems	3
ARC245	Architectural CAD V: Mechanical and Electrical Systems	3
ARC270	Architectural Technology Synthesis	3
BLT263AK	Building Codes: IBC	3
GTC124	Methods and Materials of Construction	3

Grade of "C" or better required for all courses in the Certificate of Completion in Architectural Technology.

AAS IN ARCHITECTURAL TECHNOLOGY: 65-67 credits

REQUIRED COURSES: 30 credits

ARC121	Introduction to Architectural Drafting : Manual	3
ARC141	Architectural CAD I: Introduction	3
ARC142	Architectural CAD II: Plans and Elevations	3
ARC146	Architectural Print Reading	3
ARC243	Architectural CAD III: Site Plans and Sections	3
ARC244	Architectural CAD IV: Structural Systems	3
ARC245	Architectural CAD V: Mechanical and Electrical Systems	3
ARC270	Architectural Technology Synthesis	3
BLT263AK	Building Codes: IBC	3
GTC124	Methods and Materials of Construction	3

RESTRICTED ELECTIVES: 11 credits

ARC++++	Any ARC courses	1-9
ARC296++	Cooperative Education (any suffixed courses)	1-4
ARH100	Introduction to Art	3
ART111	Drawing I	3
BLT263AL	Building Codes: IRC	3
CAD++++	Any CAD courses	1-6
CIS/BPC+++	Any Windows/Internet/Word Processing course	1-3
DFT++++	Any DFT courses	1-6
INT115	Historical Architecture and Furniture	3
INT120	Modern Architecture and Furniture	3

GENERAL EDUCATION (G.E.) REQUIREMENTS: 24-26 credits

CORE: 15-17 credits

First-Year Composition

Any approved G. E. course from the First-Year Composition area 6

Oral Communication

Any approved G. E. course from the Oral Communication area 3

Critical Reading

CRE101 Critical and Evaluative Reading I (3) OR
 equivalent as indicated by assessment. 3

Mathematics

Any approved G. E. course from the Mathematics area 3-5

DISTRIBUTION: 9 credits

Humanities and Fine Arts

Any approved G. E. course from the Humanities and Fine Arts area 2
 (ARH100 in Restricted Electives area would satisfy this category; however,
 an additional 3 credits of Restricted Electives would then have to be taken.)

Natural Sciences

Any approved G. E. course from the Natural Sciences area 4

Social and Behavioral Sciences

Any approved G. E. course from the Social/Behavioral Sciences area 3

Grade of "C" or better required for all courses in the AAS in Architectural Technology.

Scottsdale Community College Programs

BUILDING SAFETY AND PLANNING TECHNOLOGY BLT

Applied Sciences Division Office AP 237B (480) 423-6599
 Program Director, Myron Brower AP 227 (480) 423-6229

CERTIFICATE OF COMPLETION IN BUILDING SAFETY TECHNOLOGY: 30 credits

REQUIRED COURSES: 30 credits

ARC121	Introduction to Architectural Drafting: Manual	3
ARC146	Architectural Print Reading	3
BLT120	Techniques of Building Inspection	3
BLT121	Electrical Codes	3
BLT127	Plumbing Codes	3
BLT128	Mechanical Codes	3
BLT263AK	Building Codes: IBC	3
BLT263AL	Building Codes: IRC	3
GTC124	Methods and Materials of Construction	3
MAT102	Mathematical Concepts/Applications	3

Grade of "C" or better required for all courses in the Certificate of Completion in Building Safety Technology.

CERTIFICATE OF COMPLETION IN PLANNING AND DEVELOPMENT TECHNOLOGY: 30 credits

REQUIRED COURSES: 30 credits

ARC121	Introduction to Architectural Drafting: Manual	3
ARC146	Architectural Print Reading	3
BLT121	Electrical Codes	3
BLT127	Plumbing Codes	3
BLT128	Mechanical Codes	3
BLT140	Environmentally Responsible Building	3
BLT263AK	Building Codes: IBC	3
CET104	Community Planning and Development	3
GPH210	Introduction to Environmental Geography	3
MAT102	Mathematical Concepts/Applications	3

Grade of "C" or better required for all courses in the Certificate of Completion in Planning and Development Technology.

AAS IN BUILDING SAFETY AND PLANNING TECHNOLOGY: 64 credits

REQUIRED COURSES: 30 credits

ARC121	Introduction to Architectural Drafting: Manual	3
ARC146	Architectural Print Reading	3
BLT121	Electrical Codes	3
BLT127	Plumbing Codes	3
BLT128	Mechanical Codes	3
BLT263AK	Building Codes: IBC	3
MAT102	Mathematical Concepts/Applications	3

AND Option I: Planning and Development Technology Specialty

BLT140	Environmentally Responsible Building (3) AND	
CET104	Community Planning and Development (3) AND	
GPH210	Introduction to Environmental Geography (3)	9

OR Option II: Building Safety Technology Specialty

BLT120	Techniques of Building Inspection (3) AND	
BLT263AL	Building Codes: IRC (3) AND	
GTC124	Methods and Materials of Construction (3)	9

RESTRICTED ELECTIVES: 12 credits

ARC141	Architectural CAD I: Introduction	3
ARC142	Architectural CAD II: Plans and Elevations	3
ARC246	Architectural CAD VI: Construction Details	3
BIO105	Environmental Biology	4
BLT124	Designing for the Americans with Disabilities Act (ADA)	3
BLT296WC	Cooperative Education	3
BPC/CIS121AE	Windows Operating System: Level I	1
BPC/CIS133AA	Internet/Web Development Level I-A	1
GCU102	Intro to Human Geography	3
GTC122	Building Materials	3
MGT101	Techniques of Supervision	3
MGT126	Customer Service Skills and Strategies	3
MGT172	Organizations, Paradigms, and Change	1
MGT251	Human Relations in Business	3
REA179	Real Estate Principles I	3
REA180	Real Estate Principles II	3

BLT/CET/GPH/GTC: Any course in alternate area of Building Safety Technology or Planning and Development Technology specialty in Required Courses areas 3-9

GENERAL EDUCATION (G.E.) REQUIREMENTS: 22 credits

CORE: 12 credits

First-Year Composition

Any approved G. E. course from the First-Year Composition area 6

Oral Communication

Any approved G. E. course from the Oral Communication area 3

Critical Reading

CRE101 Critical and Evaluative Reading I (3) OR equivalent as indicated by assessment. 3

Mathematics

Met by MAT102 in Required Courses area 0

DISTRIBUTION: 10 credits

Humanities and Fine Arts

Any approved G. E. course from the Humanities and Fine Arts area 3

Natural Sciences

Any approved G. E. course from the Natural Sciences area 4

Social and Behavioral Sciences

Any approved G. E. course from the Social/Behavioral Sciences area 3

Grade of "C" or better required for all courses in the AAS in Building Safety and Planning Technology.

Scottsdale Community College Programs

BUSINESS (FASTRACK)

For program information and advisement, contact Mary Lynn Whitaker at the SCC Business Institute, 14350 N. 87th Street, Scottsdale, 480-425-6910, or visit www.sccbi.com.

The AAS in Business (FASTRACK) Program is designed for working adults seeking to update, upgrade or develop essential business skills. A specific objective of the program is to prepare students for job advancement and career opportunities in today's business environment as defined by industry practitioners. A Business (FASTRACK) Certificate is also available to students with all of the features of the AAS Program, but does not include a General Studies component.

Program features include:

- Student-directed learning stressing the dynamic business environment, communication skills and leadership development.
- Utilization of Microsoft Office package including Word, Excel and PowerPoint.
- Integration of international business issues and practices.
- Practical application of study concepts to workplace situations.
- Development of student portfolio intended for presentation to current or prospective employers.
- Hands-on activities and projects in accelerated five-week formats.
- Three convenient course delivery options: on campus, hybrid, and online.

On campus, instructor-led classes meet once per week for four hours with student teams obliged to complete group assignments outside of the classroom as prescribed by course/module requirements.

Hybrid classes are offered in five-week formats and blend on-campus meetings with online instruction and activities, resulting in a reduced number of classroom meetings.

Fastrack online classes begin every two weeks. Five start dates are available for fall and spring semesters, three during the summer.

How online works:

1. Assignments are posted online for convenient access 24/7.
2. Asynchronous learning, no specified meeting times. Log on from home, work, or on the road.
3. Weekly assignments due every Monday by noon.
4. Students and instructors communicate and exchange assignments via email.
5. Cautions:
 - Due to the accelerated nature of these classes, students are allowed to only take one online class at a time.
 - Students without strong time management, reading, computer and Internet skills should strongly consider the instructor-led program. **Take the online skills quiz!**
 - Students may only withdraw within the first two weeks of each five-week class. Refund requests must be received by the Admissions Office within three calendar days of start date.



CERTIFICATE OF COMPLETION IN BUSINESS (FASTRACK): 33 credits

Note: Prerequisites of program include a minimum of two years of full-time employment, very good computer skills and access to Microsoft Office software.

REQUIRED COURSES: 33 credits

ACC110	Understanding and Using Accounting Systems	3
GBS120	Workplace Communication Skills	3
GBS200	Understanding the Business Environment	3
GBS205	Legal, Ethical, and Regulatory Issues in Business	3
IBS201	International Studies for Business	3
MGT109	Development of Professional Skills and Standards	3
MGT126	Customer Service Skills and Strategies	3
MGT127	Managing and Leading for Competitive Advantage	3
MGT179	Utilizing the Human Resources Department	3
MGT206	Business Research Project (3) OR	
MGT253	Owning/Operating a Small Business (3)	3
MKT210	Applied Marketing Strategies	3

Grade of "C" or better required for all courses in the Certificate of Completion in Business (FASTRACK).

AAS IN BUSINESS (FASTRACK): 64-66 credits

Note: Prerequisites of program include a minimum of two years of full-time employment, very good computer skills and access to Microsoft Office software.

REQUIRED COURSES: 36 credits

ACC110	Understanding and Using Accounting Systems	3
BPC110	Computer Usage and Applications (3) OR	
CIS105	Survey of Computer Information Systems (3)	3
GBS120	Workplace Communication Skills	3
GBS200	Understanding the Business Environment	3
GBS205	Legal, Ethical, and Regulatory Issues in Business	3
IBS201	International Studies for Business	3
MGT109	Development of Professional Skills and Standards	3
MGT126	Customer Service Skills and Strategies	3
MGT127	Managing and Leading for Competitive Advantage	3
MGT179	Utilizing the Human Resources Department	3
MGT206	Business Research Project (3) OR	
MGT253	Owning/Operating a Small Business (3)	3
MKT210	Applied Marketing Strategies	3

RESTRICTED ELECTIVES: 3 credits

Any additional ACC, GBS, MGT or MKT course(s) listed in the college catalog 1-3

GENERAL EDUCATION (G.E.) REQUIREMENTS: 25-27 credits

CORE: 15-17 credits

First-Year Composition

ENG101	First-Year Composition (3) AND	
ENG102	First-Year Composition (3)	6

Oral Communication

Any approved G. E. course from the Oral Communication area 3

Critical Reading

CRE101	Critical and Evaluative Reading I (3) OR equivalent as indicated by assessment.	3
--------	---	---

Mathematics

Any approved G. E. course from the Mathematics area 3-5

DISTRIBUTION: 10 credits

Humanities and Fine Arts

Any approved G. E. course from the Humanities and Fine Arts area (HUM205 recommended) 3

Natural Sciences

Any approved G. E. course from the Natural Sciences area 4

Social and Behavioral Sciences

ECN111	Macroeconomic Principles (3) OR	
ECN112	Microeconomic Principles (3) OR	
PSY101	Introduction to Psychology (3) OR	
SOC101	Introduction to Sociology (3)	3

Grade of "C" or better required for all courses in the AAS in Business (FASTRACK).

Scottsdale Community College Programs

BUSINESS

Business Division Office AP 237A (480) 423-6253

The Business program is designed for students with work experience seeking to enhance career skills in a one- or two-year program. These students may choose to continue their education at the following four-year institutions which accept the AAS degree towards completion of a bachelor's degree: ASU West campus and East, Univcampusrity of Phoenix, and Western International University.

AAS IN BUSINESS: 64-66 credits

Students completing this degree will receive an AAS in Business with a specialization in any one of the following categories:

- Accounting
- Management
- Marketing
- Retail Management and Marketing
- Small Business Management

Students from previous catalogs may elect to follow this curriculum; however, they will also be allowed to complete their existing degree.

REQUIRED COURSES: Core plus one of five specializations.

CORE: 24 credits

ACC111	Accounting Principles I (3) OR	
ACC230	Uses of Accounting Information I	3
BPC110	Computer Usage and Applications (3) OR	
CIS105	Survey of Computer Information Systems (3)	3
GBS151	Introduction to Business	3
GBS205	Legal, Ethical, and Regulatory Issues in Business	3
GBS233	Business Communication	3
IBS101	Introduction to International Business	3
MGT175	Business Organization and Management	3
MKT271	Principles of Marketing	3

CHOOSE ONE OF THE FOLLOWING SPECIALIZATIONS:

Track I: Accounting specialization Credits: 15		
ACC105	Payroll, Sales and Property Taxes	3
ACC112	Accounting Principles II	3
ACC115	Computerized Accounting	2
ACC212	Managerial Accounting	3
ACC221	Tax Accounting	3
OAS118	10-Key By Touch	1
OR		
Track II: Management specialization ... Credits: 15		
GBS131	Business Calculations	3
MGT109	Development of Professional Skills and Standards	3
MGT127	Managing and Leading for Competitive Advantage (3) OR	
MGT251	Human Relations in Business (3)	3
MGT179	Utilizing the Human Resources Department (3) OR	
MGT276	Personnel/Human Resource Management (3)	3
MGT253	Owning and Operating a Small Business	3
OR		
Track III: Marketing specialization Credits: 15		
GBS131	Business Calculations	3
MKT101	Introduction to Public Relations	3
MKT263	Advertising Principles	3
MKT267	Principles of Salesmanship	3
MKT268	Merchandising	3
OR		

GBS

Track IV: Retail Management & Marketing specialization .. Credits: 15	
MKT/TEC109	Introduction to Fashion Merchandising
MKT/TEC151	Display and Visual Merchandising
MKT/TEC200	Retail Buying
MKT267	Principles of Salesmanship
MKT268	Merchandising
OR	

Track V: Small Business Management specialization Credits: 12	
SBS200	Small Business Operations
SBS202	Small Business Bookkeeping and Tax Preparation
SBS203	Financing and Cash Management for a Small Business
SBS204	Small Business Marketing and Advertising
SBS211	Small Business Computer Applications
SBS213	Hiring and Managing Employees
SBS214	Small Business Customer Relations
SBS218	Establishing an Import/Export Business
SBS220	Internet Marketing for Small Business

RESTRICTED ELECTIVES: 0-3 credits

Track I: Accounting	
No additional courses required	

Track II: Management	
No additional courses required	

Track III: Marketing	
No additional courses required	

Track IV: Retail Management and Marketing	
No additional courses required	

Track V: Small Business Management	
ACC++++	Any Accounting courses (1-3) OR
GBS++++	Any General Business courses (1-3) OR
MGT++++	Any Management courses (1-3) OR
MKT++++	Any Marketing courses (1-3) OR
SBS++++	Any Small Business courses (1-3)

GENERAL EDUCATION (G.E.) REQUIREMENTS: 25-27 credits

CORE: 15-17 credits

First-Year Composition

Any approved G. E. course from the First-Year Composition area	
--	--

Oral Communication

Any approved G. E. course from the Oral Communication area	
--	--

Critical Reading

CRE101	Critical and Evaluative Reading I (3) OR
equivalent as indicated by assessment	

Mathematics

Any approved G. E. course from the Mathematics area	
---	--

DISTRIBUTION: 10 credits

Humanities and Fine Arts

Any approved G. E. course from the Humanities and Fine Arts area	
--	--

Natural Sciences

Any approved G. E. course from the Natural Sciences area	
--	--

Social and Behavioral Sciences

ECN111	Macroeconomic Principles (3) OR
ECN112	Microeconomic Principles (3) OR
SBU200	Society and Business (3)

Grade of "C" or better required for all courses in the AAS in Business.

Continued next page...

Scottsdale Community College Programs

CERTIFICATE OF COMPLETION IN BOOKKEEPING: 27 credits

This program prepares students to work for CPA firms, corporate accounting departments and small businesses. Students with work experience and the skills developed in this program would also be able to operate their own small bookkeeping businesses.

PROGRAM PREREQUISITES: 3 credits

ENG101 First-Year Composition (3) OR
permission of the Program Director 3

REQUIRED COURSES: 27 credits

ACC105 Payroll, Sales and Property Taxes 3
 ACC111 Accounting Principles I 3
 ACC112 Accounting Principles II 3
 ACC115 Computerized Accounting 2
 ACC212 Managerial Accounting 3
 ACC221 Tax Accounting 3
 BPC110 Computer Usage and Applications 3
 GBS151 Introduction to Business 3
 GBS233 Business Communication 3
 OAS118 10-Key By Touch 1

Grade of "C" or better required for all courses in the Certificate of Completion in Bookkeeping.

CERTIFICATE OF COMPLETION IN MANAGEMENT: 30 credits

This program is designed for students who plan to attend college for one or two years only and are preparing for entry-level positions in business.

REQUIRED COURSES: 30 credits

ACC111 Accounting Principles I 3
 GBS131 Business Calculations 3
 GBS151 Introduction to Business 3
 GBS205 Legal, Ethical, and Regulatory Issues in Business 3
 MGT109 Development of Professional Skills and Standards 3
 MGT127 Managing and Leading for Competitive Advantage (3) OR
 MGT251 Human Relations in Business (3) 3
 MGT175 Business Organization and Management 3
 MGT179 Utilizing the Human Resources Department (3) OR
 MGT276 Personnel/Human Resource Management (3) 3
 MGT253 Owning and Operating a Small Business 3
 MKT271 Principles of Marketing 3

Grade of "C" or better required for all courses in the Certificate of Completion in Management.

CERTIFICATE OF COMPLETION IN MARKETING: 39 credits

This program is designed for students preparing for entry-level positions in marketing and who plan to attend college for one year only.

PROGRAM PREREQUISITES: 3 credits

ENG101 First-Year Composition (3) OR
permission of the Program Director 3

REQUIRED COURSES: 39 credits

ACC111 Accounting Principles I 3
 ACC230 Uses of Accounting Information I 3
 BPC110 Computer Usage and Applications (3) OR
 CIS105 Survey of Computer Information Systems (3) 3
 GBS131 Business Calculations 3
 GBS151 Introduction to Business 3
 GBS205 Legal, Ethical, and Regulatory Issues in Business 3
 GBS233 Business Communication 3
 MGT175 Business Organization and Management 3
 MKT101 Introduction to Public Relations 3
 MKT263 Advertising Principles 3
 MKT267 Principles of Salesmanship 3
 MKT268 Merchandising 3
 MKT271 Principles of Marketing 3

Grade of "C" or better required for all courses in the Certificate of Completion in Marketing.

CERTIFICATE OF COMPLETION IN RETAIL MANAGEMENT AND MARKETING: 30 credits

This program is designed to train students for careers in the retail clothing business: selling, merchandising and buying. The program requirements include components of management, communications, merchandise presentation, and small business development.

REQUIRED COURSES: 30 credits

GBS120 Workplace Communication Skills (3) OR
 GBS233 Business Communication (3) 3
 GBS131 Business Calculations 3
 MGT101 Techniques of Supervision 3
 MGT253 Owning and Operating a Small Business 3
 MKT/TEC109 Introduction to Fashion Merchandising 3
 MKT/TEC151 Display and Visual Merchandising 3
 MKT/TEC200 Retail Buying 3
 MKT267 Principles of Salesmanship 3
 MKT268 Merchandising 3
 MKT210 Applied Marketing Strategies (3) OR
 MKT271 Principles of Marketing (3) 3

Grade of "C" or better required for all courses in the Certificate of Completion in Retail Management and Marketing.

CERTIFICATE OF COMPLETION IN SMALL BUSINESS MANAGEMENT: 24 credits

This program prepares students to start up, organize and manage a small business operation. Areas of emphasis include effective management, utilization of resources, development of customer service culture, and marketing.

REQUIRED COURSES: 24 credits

GBS120 Workplace Communication Skills 3
 GBS205 Legal, Ethical, and Regulatory Issues in Business 3
 MGT109 Development of Professional Skills and Standards 3
 MGT251 Human Relations in Business 3
 SBS200 Small Business Operations 2
 SBS202 Small Business Bookkeeping and Tax Preparation 1
 SBS203 Financing and Cash Management for a Small Business 1
 SBS204 Small Business Marketing and Advertising 2
 SBS211 Small Business Computer Applications 1
 SBS213 Hiring and Managing Employees 1
 SBS214 Small Business Customer Relations 1
 SBS218 Establishing an Import/Export Business 1
 SBS220 Internet Marketing for Small Business 2

Grade of "C" or better required for all courses in the Certificate of Completion in Small Business Management.

Scottsdale Community College Programs

BUSINESS-PERSONAL COMPUTERS

Business Division Office AP 237A (480) 423-6253
 Program Director, Pat Serrano CM 416 (480) 423-6264

The Personal Computer Applications program is designed to provide computer skills in the areas of word processing, spreadsheets, database management, operating systems, and other software. This program is designed to provide students with basic business and computer applications skills necessary for employment in a wide variety of entry-level positions in business.

Scottsdale Community College participates in the Microsoft® Solutions Developers Network Academic Alliance (MSDNAA). These classes can help you prepare to take examinations for MOS (Microsoft Office Specialist), MCSE (Microsoft Certified Systems Engineer), MCSA (Microsoft Certified System Administrator), i-Net+, and A+ certifications.

ALSO SEE: Computer Hardware and Network Support, page 80
 Computer Information Systems, page 81
 Microsoft Networking Technology, page 103
 Microsoft Applications Development, page 104
 Network Administration, page 82
 Office Automation Systems, page 112
 Programming and System Analysis, page 83
 Web Design, page 84
 Web Development, page 85

CERTIFICATE OF COMPLETION IN PERSONAL COMPUTER APPLICATIONS: 36-38 credits

REQUIRED COURSES: 24-26 credits

BPC110	Computer Usage and Applications	3
BPC111AA	Computer Keyboarding I (1) OR	
OAS101AA	Computer Typing I: Keyboard Mastery (1)	1
BPC/CIS114+	Any two spreadsheet modules (1)	2
BPC/CIS117+	Any Database Management modules (1-3)	3
BPC/CIS118AB	PowerPoint: Level I	1
BPC/CIS121AB	Microsoft Command Line Operations	1
BPC/CIS121AE	Windows Operating System: Level I	1
BPC/CIS133AA	Internet/Web Development Level I-A	1
BPC/CIS133BA	Internet/Web Development Level I-B	1
BPC/OAS135++	Any Word Processing DD or DK module	2
BPC/OAS235++	Any Advanced Word Processing DD or DK module	2
ENG101	First-Year Composition	3
GBS131	Business Calculations (3) OR	
MAT102	Mathematical Concepts/Applications (3) OR	
MAT120	Intermediate Algebra (5) OR	
MAT122	Intermediate Algebra (3)	3-5

RESTRICTED ELECTIVES: 12 credits

ACC111	Accounting Principles I	3
ACC115	Computerized Accounting	2
BPC125	Microcomputer Set Up and Maintenance	1
BPC138++	Any Desktop Publishing module	3
BPC170	Computer Maintenance I: A+ Prep	3
BPC/OAS235++	Any additional Advanced Word Processing module	2
CIS190	Introduction to Local Area Networks	3
CIS+++	Any other CIS courses	1-3
MST150	Microsoft Windows Professional	3

Grade of "C" or better required for all courses in the Certificate of Completion in Personal Computer Applications.

BPC

COMPUTER INFORMATION SYSTEMS

CIS

Computer Information Systems Programs

Business Division Office AP 237A (480) 423-6253
 Program Director, Pat Serrano CM 416 (480) 423-6264

The Computer Information Systems program provides training for various entry-level positions in computer systems. Career opportunities include LAN administrator, systems analyst, computer programmer, computer operator, computer hardware and software salesperson. The programs offered at SCC include a two-year career program that leads to an Associate in Applied Science in Computer Information Systems and a Certificate of Completion in Computer Information Systems. The Certificate of Completion in Computer Hardware and Network Support is designed to prepare students for entry-level network technician jobs and to help prepare them for multiple industry certification examinations. The Certificate of Completion in Database Development prepares students to design and implement the infrastructure for business solutions using database and programming tools. The Certificate of Completion in Software Development prepares students for entry-level positions in software development, including corporate web systems using interactive applications.

Scottsdale Community College participates in the Microsoft® Solutions Developers Network Academic Alliance (MSDNAA). These classes can help you prepare to take examinations for MOS (Microsoft Office Specialist), MCSE (Microsoft Certified Systems Engineer), MCSA (Microsoft Certified System Administrator), i-Net+, and A+ certifications.

ALSO SEE: Computer Information Systems, page 81
 Microsoft Networking Technology, page 103
 Microsoft Applications Development, page 104
 Network Administration, page 82
 Web Design, page 84
 Web Development, page 85

CERTIFICATE OF COMPLETION IN COMPUTER HARDWARE AND NETWORK SUPPORT: 23 credits

REQUIRED COURSES: 23 credits

BPC/CIS121AB	Microsoft Command Line Operations	1
BPC170	Computer Maintenance I: A+ Prep	3
BPC270	Microcomputer Maintenance II	3
CIS102	Interpersonal/Customer Service Skills for IT Professionals	1
CIS105	Survey of Computer Information Systems	3
CIS126DA	UNIX Operating System	3
CIS190	Introduction to Local Area Networks (3) OR	
MST140	Microsoft Networking Essentials (3)	3
CIS191	Novell NetWare System Administration (3) OR	
MST150	Microsoft Windows Professionals (3)	3
CIS240	Local Area Network Planning and Design	3

Grade of "C" or better required for all courses in the Certificate of Completion in Computer Hardware and Network Support.

CERTIFICATE OF COMPLETION IN DATABASE DEVELOPMENT: 29 credits

REQUIRED COURSES: 29 credits

BPC/CIS117DM	Microsoft Access: Database Management	3
BPC/CIS217AM	Advanced Microsoft Access: Database Management	3
CIS105	Survey of Computer Information Systems (3)	3
CIS119DO	Introduction to Oracle: SQL and PL/SQL	3
CIS150	Programming Fundamentals	3
CIS159	Visual Basic Programming I	3
CIS164AB	Oracle: PL/SQL Programming	3
CIS164AC	Oracle: Developer Forms I (3) OR	
CIS164AE	Oracle: Developer Reports (3)	3
CIS164AG	Oracle: Data Modeling and Relational Database Design	2
CIS225AB	Object-Oriented Analysis and Design	3

Grade of "C" or better required for all courses in the Certificate of Completion in Database Development.

Scottsdale Community College Programs

CERTIFICATE OF COMPLETION IN SOFTWARE DEVELOPMENT: 36 credits

PROGRAM PREREQUISITES: 3 credits

CIS105 Survey of Computer Information Systems (3) OR
permission of department 3

REQUIRED COURSES: 30 credits

BPC/CIS117DM Microsoft Access: Database Management 3
BPC/CIS217AM Advanced Microsoft Access: Database Management 3
CIS126DA UNIX Operating System 3
CIS150 Programming Fundamentals 3
CIS159 Visual Basic Programming I 3
CIS225AB Object-Oriented Analysis and Design 3
CIS234 XML Application Development 3
CIS259 Visual Basic Programming II 3
CIS263AA Java Programming: Level II 3
CIS280 Current Topics in Computing 3

RESTRICTED ELECTIVES: 6 credits

BPC/CIS133DA Internet/Web Development Level I 3
CIS119DO Introduction to Oracle: SQL 3
CIS166 Web Scripting/Programming 3
CIS233DA Internet/Web Development Level II 3
CIS235 e-Commerce 3
CIS++++ Any other programming language 3

Grade of "C" or better required for all courses in the Certificate of Completion in Software Development.

CERTIFICATE OF COMPLETION IN COMPUTER INFORMATION SYSTEMS: 39-41 credits

REQUIRED COURSES: 25-27 credits

BPC/CIS117++ Any Database Management module (1-3) OR
CIS119++ Any Oracle Database Management module (1-3) 3
BPC/CIS121AB Microsoft Command Line Operations 1
CIS105 Survey of Computer Information Systems 3
CIS150 Programming Fundamentals 3
CIS159 Visual Basic Programming I 3
CIS162AC Visual C++: Level I 3
CIS225 Business Systems Analysis and Design 3
ENG101 First-Year Composition 3
GBS131 Business Calculations (3) OR
MAT102 Mathematical Concepts/Applications (3) OR
MAT120 Intermediate Algebra (5) OR
MAT122 Intermediate Algebra (3) 3-5

RESTRICTED ELECTIVES: 14 credits

BPC/CIS133AA Internet/Web Development Level I-A 1
BPC/CIS133BA Internet/Web Development Level I-B 1
BPC/CIS217AM Advanced Microsoft Access: Database Management 3
CIS158 COBOL Programming I 3
CIS163AA Java Programming: Level I 3
CIS164++ Oracle (any module) 2-3
CIS166 Web Scripting/Programming 3
CIS167AA C++ Object-Oriented Programming 3
CIS190 Introduction to Local Area Networks 3
CIS191 Novell NetWare System Administration 3
CIS219DO Oracle: Extended Data Retrieval with SQL 1
CIS233DA Internet/Web Development Level II 3
CIS234 XML Application Development 3
CIS235 e-Commerce 3
CIS258 COBOL Programming II 3
CIS259 Visual Basic Programming II 3
CIS262AC Visual C++: Level II 3
CIS263AA Java Programming: Level II 3
CIS268 Microsoft Visual InterDev for Web Developers 3
CIS275++ Any CIS275 module 3
CIS277++ Any CIS277 module 3
CIS280 Current Topics in Computing 3

CIS296WC Cooperative Education 3
CNT+++ Any Cisco course 3
CSC+++ Any Computer Science course 3
MST+++ Any Microsoft course 3

Grade of "C" or better required for all courses in the Certificate of Completion in Computer Information Systems.

AAS IN COMPUTER INFORMATION SYSTEMS: 64-66 credits

REQUIRED COURSES: 22 credits

BPC/CIS117++ Any Database Management module(s) (1-3) OR
CIS119++ Any Oracle Database Management module(s) (1-3) 3
BPC/CIS121AB Microsoft Command Line Operations 1
CIS105 Survey of Computer Information Systems 3
CIS126DA UNIX Operating System 3
CIS150 Programming Fundamentals 3
CIS159 Visual Basic Programming I 3
CIS162AC Visual C++: Level I 3
CIS225 Business Systems Analysis and Design 3

RESTRICTED ELECTIVES: 17 credits

BPC/CIS133AA Internet/Web Development Level I-A 1
BPC/CIS133BA Internet/Web Development Level I-B 1
BPC/CIS133DA Internet/Web Development Level I 3
BPC/CIS217AM Advanced Microsoft Access: Database Management 3
CIS158 COBOL Programming I 3
CIS163AA Java Programming: Level I 3
CIS164++ Oracle (any module) 2-3
CIS166 Web Scripting/Programming 3
CIS167AA C++ Object-Oriented Programming 3
CIS190 Introduction to Local Area Networks 3
CIS191 Novell NetWare System Administration 3
CIS219DO Oracle: Extended Data Retrieval with SQL 1
CIS233DA Internet/Web Development Level II 3
CIS235 e-Commerce 3
CIS258 COBOL Programming II 3
CIS259 Visual Basic Programming II 3
CIS262AC Visual C++: Level II 3
CIS263AA Java Programming: Level II 3
CIS268 Microsoft Visual InterDev for Web Developers 3
CIS275++ Any CIS275 module 1-3
CIS277++ Any CIS277 module 3
CIS280 Current Topics in Computing 3
CIS296WC Cooperative Education 3
CNT+++ Any Cisco course 3
CSC+++ Any Computer Science course 3
MST+++ Any Microsoft course 3

GENERAL EDUCATION (G.E.) REQUIREMENTS: 25-27 credits

CORE: 15-17 credits

First-Year Composition

Any approved G. E. course from the First-Year Composition area 6

Oral Communication

Any approved G. E. course from the Oral Communication area 3

Critical Reading

CRE101 Critical and Evaluative Reading I (3) OR
equivalent as indicated by assessment. 3

Mathematics

Any approved G. E. course from the Mathematics area 3-5

DISTRIBUTION: 10 credits

Humanities and Fine Arts

Any approved G. E. course from the Humanities and Fine Arts area 3

Natural Sciences

Any approved G. E. course from the Natural Sciences area 4

Social and Behavioral Sciences

Any approved G. E. course from the Social/Behavioral Sciences area 3

Grade of "C" or better required for all courses in the AAS in Computer Information Systems.

Scottsdale Community College Programs

COMPUTER INFORMATION SYSTEMS

CIS

Network Administration Program

Business Division Office AP 237A (480) 423-6253
 Program Director, Pat Serrano CM 416 (480) 423-6264

The Certificate of Completion and the Associate in Applied Science in Network Administration are designed to provide the student with training for a variety of entry-level positions related to computer systems. Career opportunities include Local Area Network (LAN) administrator, systems analyst and technical support.

Scottsdale Community College participates in the Microsoft® Solutions Developers Network Academic Alliance (MSDNAA). These classes can help you prepare to take examinations for MOS (Microsoft Office Specialist), MCSE (Microsoft Certified Systems Engineer), MCSA (Microsoft Certified System Administrator), i-Net+, and A+ certifications.

ALSO SEE: Computer Hardware and Network Support, page 80
 Computer Information Systems, page 81
 Microsoft Applications Development, page 104
 Microsoft Networking Technology, page 103
 Network Administration, page 82
 Office Automation Systems, page 112
 Personal Computer Applications, page 80
 Programming and System Analysis, page 83
 Web Design, page 84
 Web Development, page 85

CERTIFICATE OF COMPLETION IN NETWORK ADMINISTRATION: 39 credits

REQUIRED COURSES: 33 credits

BPC/CIS117DM	Microsoft Access: Database Management	3
BPC/CIS121AB	Microsoft Command Line Operations	1
BPC170	Computer Maintenance I: A+ Prep	3
CIS102	Interpersonal/Customer Service Skills for IT Professionals	1
CIS105	Survey of Computer Information Systems	3
CIS126DA	UNIX Operating System	3
CIS175SA	Interconnecting Cisco Network Devices	3
CIS190	Introduction to Local Area Networks (3) OR	3
MST140	Microsoft Networking Essentials (3)	3
CIS191	Novell NetWare System Administration	3
CIS240	Local Area Network Planning and Design	3
MST150	Microsoft Windows Professional	3
MST152	Microsoft Windows Server	4

RESTRICTED ELECTIVES: 6 credits

BPC/CIS133DA	Internet/Web Development Level I	3
BPC270	Microcomputer Maintenance II	3
CIS150	Programming Fundamentals	3
CIS159	Visual Basic Programming I	3
CIS162AC	Visual C++: Level I	3
CIS225	Business Systems Analysis and Design	3
CIS280	Current Topics in Computing	3
CIS296WC	Cooperative Education	3
CSC+++	Any Computer Science course	3
MST+++	Any Microsoft course	3

Grade of "C" or better required for all courses in the Certificate of Completion in Network Administration.

AAS IN NETWORK ADMINISTRATION: 64-66 credits

REQUIRED COURSES: 33 credits

BPC/CIS117DM	Microsoft Access: Database Management	3
BPC/CIS121AB	Microsoft Command Line Operations	1
BPC170	Computer Maintenance I: A+ Prep	3
CIS102	Interpersonal/Customer Service Skills for IT Professionals	1
CIS105	Survey of Computer Information Systems	3
CIS126DA	UNIX Operating System	3
CIS175SA	Interconnecting Cisco Network Devices	3
CIS190	Introduction to Local Area Networks (3) OR	3
MST140	Microsoft Networking Essentials (3)	3
CIS191	Novell NetWare System Administration	3
CIS240	Local Area Network Planning and Design	3
MST150	Microsoft Windows Professional	3
MST152	Microsoft Windows Server	4

RESTRICTED ELECTIVES: 6 credits

BPC/CIS133DA	Internet/Web Development Level I	3
BPC270	Microcomputer Maintenance II	3
CIS150	Programming Fundamentals	3
CIS159	Visual Basic Programming I	3
CIS162AC	Visual C++: Level I	3
CIS225	Business Systems Analysis and Design	3
CIS280	Current Topics in Computing	3
CIS296WC	Cooperative Education	3
CSC+++	Any Computer Science course	3
MST+++	Any Microsoft course	3

GENERAL EDUCATION (G.E.) REQUIREMENTS: 25-27 credits

CORE: 15-17 credits

First-Year Composition

Any approved G.E. course in the First-Year Composition area 6

Oral Communication

Any approved G.E. course in the Oral Communication area 3

Critical Reading

CRE101 Critical and Evaluative Reading I (3) OR
 equivalent as indicated by assessment. 3

Mathematics

Any approved G. E. course from the Mathematics area 3-5

DISTRIBUTION: 10 credits

Humanities and Fine Arts

Any approved G. E. course from the Humanities and Fine Arts area 3

Natural Sciences

Any approved G. E. course from the Natural Sciences area 4

Social and Behavioral Sciences

Any approved G. E. course from the Social/Behavioral Sciences area 3

Grade of "C" or better required for all courses in the AAS in Network Administration.

Scottsdale Community College Programs

COMPUTER INFORMATION SYSTEMS

Programming and System Analysis Program

Business Division Office AP 237A (480) 423-6253
 Program Director, Pat Serrano CM 416 (480) 423-6264

The Certificate of Completion and the Associate in Applied Science in Programming and System Analysis provide an in-depth exploration of different computer language and technical skills. Also included in the program are operating systems, local area networks, business communication, team roles, and dynamics.

ALSO SEE: Computer Hardware and Network Support, page 80
 Computer Information Systems, page 81
 Microsoft Networking Technology, page 103
 Microsoft Applications Development, page 104
 Network Administration, page 82
 Office Automation Systems, page 112
 Personal Computer Applications, page 80
 Web Design, page 84
 Web Development, page 85

CERTIFICATE OF COMPLETION IN PROGRAMMING AND SYSTEM ANALYSIS: 25-26 credits

REQUIRED COURSES: 25-26 credits

BPC/CIS117DM	Microsoft Access: Database Management (3) OR (Modular equivalents)	3
CIS105	Survey of Computer Information Systems	3
CIS121AB	Microsoft Command Line Operations (1) OR	
CIS121AE	Windows Operating System: Level I (1) OR	
CIS126A+	Any Level I operating system module (1)	1
CIS150++	Any Programming Fundamentals course	3
CIS159	Visual Basic Programming I (3) OR	
CIS162++	Any Level I C language course (3) OR	
CIS163AA	Java Programming: Level I (3)	3
	(Note: Select 2 of the 3 courses for a total of 6 credits)	6
CIS190	Introduction to Local Area Networks (3) OR	
CNT140	Cisco Networking Basics (4) OR	
MST140	Microsoft Networking Essentials (3)	3-4
CIS225++	Any analysis and design course	3
GBS233	Business Communication	3

Note: ENG101 or ENG107 with a grade of C or better or permission of department/division is prerequisite to GBS233.
 Grade of "C" or better required for all courses in the Certificate of Completion in Programming and System Analysis.

CIS

AAS IN PROGRAMMING AND SYSTEM ANALYSIS: 62-63 credits

PROGRAM PREREQUISITES: 3 credits

CRE101 Critical and Evaluative Reading I (3) OR
 equivalent by assessment

REQUIRED COURSES: 25-26 credits

BPC/CIS117DM	Microsoft Access: Database Management (3) OR (Modular equivalents)	3
CIS105	Survey of Computer Information Systems	3
CIS121AB	Microsoft Command Line Operations (1) OR	
CIS121AE	Windows Operating System: Level I (1) OR	
CIS126A+	Any Level I operating system module (1)	1
CIS150++	Any Programming Fundamentals course	3
CIS159	Visual Basic Programming I	3
CIS162++	Any Level I C language course	3
CIS190	Introduction to Local Area Networks (3) OR	
CNT140	Cisco Networking Basics (4) OR	
MST140	Microsoft Networking Essentials (3)	3-4
CIS225++	Any analysis and design course	3
GBS233	Business Communication	3

RESTRICTED ELECTIVES: 15 credits

CIS126DA	UNIX Operating System	3
CIS163AA	Java Programming: Level I	3
CIS166++	Any scripting course	3
CIS169	Introduction to Visual Basic for Applications	3
CIS224	Project Management Microsoft Project for Windows	3
CIS250	Management Information Systems	3
CIS259	Visual Basic Programming II	3
CIS262++	Any Level II C language course	3
CIS263AA	Java Programming: Level II	3
CIS290AC	Computer Information Systems Internship	3

GENERAL EDUCATION (G.E.) REQUIREMENTS: 22 credits

CORE: 12 credits

First-Year Composition

ENG101	First-Year Composition (3) OR	
ENG107	First-Year Composition for ESL (3) AND	
ENG102	First-Year Composition (3) OR	
ENG108	First-Year Composition for ESL (3)	6

Oral Communication

Any approved G. E. course from the Oral Communication area

Critical Reading

Met by CRE101 in Program Prerequisites area

Mathematics

MAT212 Brief Calculus

DISTRIBUTION: 10 credits

Humanities and Fine Arts

Any approved G. E. course from the Humanities and Fine Arts area

Natural Sciences

Any approved G. E. course from the Natural Sciences area

Social and Behavioral Sciences

ECN111	Macroeconomic Principles (3) OR	
ECN112	Microeconomic Principles (3) OR	
SBU200	Society and Business (3)	3

Grade of "C" or better required for all courses in the AAS in Programming and System Analysis.

Scottsdale Community College Programs

COMPUTER INFORMATION SYSTEMS

CIS

Web Design Program

Business Division Office AP 237A (480) 423-6253
 Program Director, Pat Serrano CM 416 (480) 423-6264

The Web Design program prepares students to design, create and administer interactive and professional web sites. Students gain hands-on experience with web page navigation, web publishing, web graphics preparation, database design and development, and e-commerce solutions (including store front setup). This program focuses on user interface technologies such as Extensible Hyper Text Markup Language (XHTML), Cascading Style Sheets, JavaScript and Flash.

Completing the program may lead to such positions as web designer, web marketing manager, web manager, or e-commerce manager.

ALSO SEE: Computer Hardware and Network Support, page 80
 Computer Information Systems, page 81
 Microsoft Networking Technology, page 103
 Microsoft Applications Development, page 104
 Network Administration, page 82
 Office Automation Systems, page 112
 Personal Computer Applications, page 80
 Web Development, page 85

CERTIFICATE OF COMPLETION IN WEB DESIGN: 36 credits

REQUIRED COURSES: 36 credits

ART/MMT190	Art of Web Site Design	3
BPC/CIS117DM	Microsoft Access: Database Management	3
BPC/CIS133DA	Internet/Web Development Level I	3
CIS105	Survey of Computer Information Systems	3
CIS119DO	Introduction to Oracle: SQL	3
CIS120DC	Computer Graphics: Macromedia Flash	3
CIS126DA	UNIX Operating System (3) OR	
CIS126DL	Linux Operating System (3)	3
CIS166	Web Scripting/Programming	3
CIS220DC	Advanced Web Programming with Macromedia Flash	3
CIS226++	Internet/Intranet Server Administration (any module)	3
CIS233DA	Internet/Web Development Level II	3
CIS235	e-Commerce	3

Grade of "C" or better required for all courses in the Certificate of Completion in Web Design.

AAS IN WEB DESIGN: 60-63 credits

REQUIRED COURSES: 36 credits

ART/MMT190	Art of Web Site Design	3
BPC/CIS117DM	Microsoft Access: Database Management	3
BPC/CIS133DA	Internet/Web Development Level I	3
CIS105	Survey of Computer Information Systems	3
CIS119DO	Introduction to Oracle: SQL	3
CIS120DC	Computer Graphics: Macromedia Flash	3
CIS126DA	UNIX Operating System (3) OR	
CIS126DL	Linux Operating System (3)	3
CIS166	Web Scripting/Programming	3
CIS220DC	Advanced Web Programming with Macromedia Flash	3
CIS226++	Internet/Intranet Server Administration (any module)	3
CIS233DA	Internet/Web Development Level II	3
CIS235	e-Commerce	3

GENERAL EDUCATION (G.E.) REQUIREMENTS: 24-27 credits

CORE: 15-17 credits

First-Year Composition

Any approved G. E. course from the First-Year Composition area 6

Oral Communication

Any approved G. E. course from the Oral Communication area 3

Critical Reading

CRE101 Critical and Evaluative Reading I (3) OR
 equivalent as indicated 3

Mathematics

Any approved G. E. course from the Mathematics area 3-5

DISTRIBUTION: 9-10 credits

Humanities and Fine Arts

Any approved G. E. course from the Humanities and Fine Arts area 2-3

Natural Sciences

Any approved G. E. course from the Natural Sciences area 4

Social and Behavioral Sciences

Any approved G. E. course from the Social/Behavioral Sciences area 3

Grade of "C" or better required for all courses in the AAS in Web Design.

Scottsdale Community College Programs

COMPUTER INFORMATION SYSTEMS

CIS

Web Development Program

Business Division Office AP 237A (480) 423-6253
 Program Director, Pat Serrano CM 416 (480) 423-6264

The Web Development program prepares students to design, create and administer interactive and professional web sites that utilize server side programming technologies. Web page navigation, web publishing, web graphics preparation, database design and development, and e-commerce solutions (including store front setup) are integral components of this degree, which focuses on server-side programming. In addition to web page creation, students study object-oriented systems analysis and design methods, structured programming logic and design, programming in an Object Oriented Programming Language, database design and development using both Microsoft Access and Oracle, and application development with XML.

Completing the program may lead to such positions as web designer, web developer, web marketing manager, web manager, e-commerce manager, web programmer, web technician, or web server administrator.

ALSO SEE: Computer Hardware and Network Support, page 80
 Computer Information Systems, page 81
 Microsoft Networking Technology, page 103
 Microsoft Applications Development, page 104
 Network Administration, page 82
 Office Automation Systems, page 112
 Personal Computer Applications, page 80
 Web Design, page 84

CERTIFICATE OF COMPLETION IN WEB DEVELOPMENT: 42 credits

REQUIRED COURSES: 42 credits

BPC/CIS117DM	Microsoft Access: Database Management	3
BPC/CIS133DA	Internet/Web Development Level I	3
CIS105	Survey of Computer Information Systems	3
CIS119DO	Introduction to Oracle: SQL	3
CIS126DA	UNIX Operating System (3) OR	
CIS126DL	Linux Operating System (3)	3
CIS150	Programming Fundamentals	3
CIS159	Visual Basic Programming I (3) OR	
CIS162++	Any module (3) OR	
CIS163AA	Java Programming: Level I (3)	3
CIS166	Web Scripting/Programming	3
CIS225AB	Object-Oriented Analysis and Design	3
CIS226++	Internet/Intranet Server Administration (any module)	3
CIS233DA	Internet/Web Development Level II	3
CIS234	XML Application Development	3
CIS235	e-Commerce	3
CIS259	Visual Basic Programming II (3) OR	
CIS262++	Any module (3) OR	
CIS263AA	Java Programming: Level II (3)	3

Grade of "C" or better required for all courses in the Certificate of Completion in Web Development.

AAS IN WEB DEVELOPMENT: 63-66 credits

PROGRAM PREREQUISITES: 3 credits

CRE101	Critical and Evaluative Reading I (3) OR Equivalent by assessment	3
--------	--	---

REQUIRED COURSES: 42 credits

BPC/CIS117DM	Microsoft Access: Database Management	3
BPC/CIS133DA	Internet/Web Development Level I	3
CIS105	Survey of Computer Information Systems	3
CIS119DO	Introduction to Oracle: SQL	3
CIS126DA	UNIX Operating System (3) OR	
CIS126DL	Linux Operating System (3)	3
CIS150	Programming Fundamentals	3
CIS159	Visual Basic Programming I (3) OR	

CIS162++	Any module (3) OR	
CIS163AA	Java Programming: Level I (3)	3
CIS166	Web Scripting/Programming	3
CIS225AB	Object-Oriented Analysis and Design	3
CIS226++	Internet/Intranet Server Administration (any module)	3
CIS233DA	Internet/Web Development Level II	3
CIS234	XML Application Development	3
CIS235	e-Commerce	3
CIS259	Visual Basic Programming II (3) OR	
CIS262++	Any module (3) OR	
CIS263AA	Java Programming: Level II (3)	3

GENERAL EDUCATION (G.E.) REQUIREMENTS: 21-24 credits

CORE: 12-14 credits

First-Year Composition

Any approved G. E. course from the First-Year Composition area 6

Oral Communication

Any approved G. E. course from the Oral Communication area 3

Critical Reading

Met by CRE101 OR equivalent as indicated by assessment
 in Program Prerequisite area 0

Mathematics

Any approved G. E. course from the Mathematics area 3-5

DISTRIBUTION: 9-10 credits

Humanities and Fine Arts

Any approved G. E. course from the Humanities and Fine Arts area 2-3

Natural Sciences

Any approved G. E. course from the Natural Sciences area 4

Social and Behavioral Sciences

Any approved G. E. course from the Social/Behavioral Sciences area 3

Grade of "C" or better required for all courses in the AAS in Web Development.

COMPUTER SCIENCE

CSC

Mathematics/Sciences Division Office PS 153 (480) 423-6111
 CSC Course Coordinator, Gerald Thurman CM 424 (480) 423-6110

Scottsdale Community College offers many lower-division courses in computer science and computer systems engineering. Our goal is to provide transfer students and computer professionals with a solid education in the fundamental principles and concepts of computer science.

These courses may be of interest to the transfer student interested in a Computer Science degree:

CHM151	General Chemistry I	3
CHM152	General Chemistry II	3
CSC110AA	Introduction to Computer Science (Java)	3
CSC200AA	Principles of Computer Science (Java)	3
CSC200AB	Principles of Computer Science (Java)	4
CSC210AB	Data Structures and Algorithms (Java)	4
ECE102	Engineering Analysis Tools and Techniques	2
ECE103	Engineering Problem Solving and Design	2
ECE211	Engineering Mechanics-Statics	3
MAT220	Analytic Geometry and Calculus I	5
MAT227	Discrete Mathematical Structures	3
MAT230	Analytic Geometry and Calculus II	5
MAT240	Calculus with Analytic Geometry III	5
MAT261	Differential Equations	4
PHY115	University Physics I	5
PHY116	University Physics II	5

The following courses may appeal to students interested in technical elective credit, those with prior programming experience or those with a professional interest:

CSC185	World Wide Web and Introductory Internet Programming	3
CSC285	Computer Programming in the WWW Environment	4
CSC294AA	Special Topics in Computing	3

Contact the CSC Course Coordinator for advice regarding particular needs.

Scottsdale Community College Programs

CULINARY ARTS

Hospitality, Tourism, and Culinary Arts

Division Office AP 253 (480) 423-6578
 Program Director, Karen Chalmers AP 254 (480) 423-6241

The Culinary Arts Program offers multiple certificate and AAS courses of study for students. Further information on all programs may be obtained by calling the Culinary Arts office (480-423-6241), the division office (480-423-6578), or by visiting the website at www.scottsdalecc.edu/culinary. The program is proud to be accredited by the American Culinary Federation.

Culinary Block Program

The Block Certificate Program accepts 36 students each semester through an application and interview process. Interested students are encouraged to apply well in advance of their intended semester of enrollment. A lab fee of \$425.00 is required upon acceptance.

Advanced Professional Culinary Arts Courses

Advanced Professional Culinary Arts courses are designed to enhance and refine the skills of current employees in the culinary industry, as well as graduates from basic culinary certificate programs. Instruction is provided in intensive, hands-on formats, emphasizing specialized techniques in each course area. NOTE: All classes in the advanced program require students to have a kitchen uniform consisting of a chef's coat, chef's pants, kitchen apron and standard knives and tools.

ALSO SEE: Hospitality and Tourism/Hotel Management and Hospitality and Tourism/Restaurant Management (HRM), page 99.

CERTIFICATE OF COMPLETION IN CULINARY ARTS: 34 credits

ADMISSION CRITERIA:

Entrance into program is by application only. A special fee of \$425 is required each semester in addition to the regular tuition fees. Placement into 100-level English, reading and math classes on the ASSET test, or completion of equivalent coursework.

REQUIRED COURSES: 34 credits

CUL110	Food Service Nutrition	2
CUL115	Food Service Sanitation, Safety and Stewarding	2
CUL126	Food Costing, Purchasing and Inventory Control	2
CUL130	Hot Foods I	3
CUL140	Culinary Principles and Kitchen Management I	3
CUL150	Garde Manger I	2
CUL160	Bakery and Pastry Production I	3
CUL170	Dining Room Operations I	2
CUL210	Menu Planning and Facilities Design	2
CUL230	Hot Foods II	3
CUL240	Culinary Principles and Kitchen Management II	3
CUL250	Garde Manger II	2
CUL260	Bakery and Pastry Production II	2
CUL270	Dining Room Operations II	3

Grade of "C" or better required for all courses in the Certificate of Completion in Culinary Arts.

CUL

AAS IN CULINARY ARTS: 65-67 credits

ADMISSION CRITERIA:

Entrance into program is by application only. A special fee of \$425 is required each semester in addition to the regular tuition fees. Placement into 100-level English, reading and math classes on the ASSET test, or completion of equivalent coursework.

REQUIRED COURSES: 34 credits

CUL110	Food Service Nutrition	2
CUL115	Food Service Sanitation, Safety and Stewarding	2
CUL126	Food Costing, Purchasing and Inventory Control	2
CUL130	Hot Foods I	3
CUL140	Culinary Principles and Kitchen Management I	3
CUL150	Garde Manger I	2
CUL160	Bakery and Pastry Production I	3
CUL170	Dining Room Operations I	2
CUL210	Menu Planning and Facilities Design	2
CUL230	Hot Foods II	3
CUL240	Culinary Principles and Kitchen Management II	3
CUL250	Garde Manger II	2
CUL260	Bakery and Pastry Production II	2
CUL270	Dining Room Operations II	3

RESTRICTED ELECTIVES: 6 credits

CUL180	Food in History	3
CUL190	Catering Operations I	3
CUL235	Advanced Culinary Techniques I - Meats	2
CUL236	Advanced Culinary Techniques II - Seafood	2
CUL237	Advanced Culinary Techniques III - Game and Poultry	2
CUL245	Professional Kitchen Management Techniques	2
CUL255	Advanced Garde Manger I - Salads and Sandwiches	2
CUL256	Advanced Garde Manger II - Appetizers and Hors d'Oeuvres ...	2
CUL265	Professional Baking I - Base Products and Sauces	2
CUL266	Professional Baking II - Breads and Rolls	2
CUL267	Professional Baking III - Pastries, Pies and Cakes	2
CUL268	Professional Baking IV - Decorative and Design Work	2
CUL296++	Cooperative Education (any module)	1-4
CUL298++	Special Projects (any module)	1-3
HRM110	Introduction to Hospitality and Tourism Management	3
HRM150	Hospitality and Tourism Information Systems I	3
HRM230	Beverage Management	3
HRM275	Restaurant Management	3
HRM280	Hospitality and Tourism Law	3

GENERAL EDUCATION (G.E.) REQUIREMENTS: 25-27 credits

CORE: 15-17 credits

First-Year Composition

ENG101	First-Year Composition (3) OR	
ENG107	First-Year Composition for ESL (3) AND	
ENG102	First-Year Composition (3) OR	
ENG108	First-Year Composition for ESL (3)	6

Oral Communication

Any approved G.E. course from the Oral Communication area 3

Critical Reading

CRE101	Critical and Evaluative Reading I (3) OR equivalent as indicated	3
--------	---	---

Mathematics

Any approved G. E. course from the Mathematics area 3-5

DISTRIBUTION: 10 credits

Humanities and Fine Arts

Any approved G. E. course from the Humanities and Fine Arts area 3

Natural Sciences

Any approved G. E. course from the Natural Sciences area 4

Social and Behavioral Sciences

Any approved G. E. course from the Social/Behavioral Sciences area 3

Grade of "C" or better required for all courses in the AAS in Culinary Arts.

Scottsdale Community College Programs

CERTIFICATE OF COMPLETION IN ADVANCED PROFESSIONAL CULINARY ARTS: 20 credits

PROGRAM PREREQUISITES:

High school diploma or GED AND
A score of 37 or higher on the math portion of the ASSET Placement Test AND
A Certificate of Completion in Culinary Arts OR
Two years of work experience in a professional kitchen position OR
Permission of Program Director.

REQUIRED COURSES: 20 credits

CUL235	Advanced Culinary Techniques I - Meats	2
CUL236	Advanced Culinary Techniques II - Seafood	2
CUL237	Advanced Culinary Techniques III - Game and Poultry	2
CUL245	Professional Kitchen Management Techniques	2
CUL255	Advanced Garde Manger I - Salads and Sandwiches	2
CUL256	Advanced Garde Manger II - Appetizers and Hors d'Oeuvres ...	2
CUL265	Professional Baking I - Base Products and Sauces	2
CUL266	Professional Baking II - Breads and Rolls	2
CUL267	Professional Baking III - Pastries, Pies and Cakes	2
CUL268	Professional Baking IV - Decorative and Design Work	2

Grade of "C" or better required for all courses in the Certificate of Completion in Advanced Professional Culinary Arts.

AAS IN ADVANCED PROFESSIONAL CULINARY ARTS: 60 credits

PROGRAM PREREQUISITES:

High school diploma or GED AND
A score of 37 or higher on the math portion of the ASSET Placement Test AND
A Certificate of Completion in Culinary Arts OR
Two years of work experience in a professional kitchen position OR
Permission of Program Director.

REQUIRED COURSES: 20 credits

CUL235	Advanced Culinary Techniques I - Meats	2
CUL236	Advanced Culinary Techniques II - Seafood	2
CUL237	Advanced Culinary Techniques III - Game and Poultry	2
CUL245	Professional Kitchen Management Techniques	2
CUL255	Advanced Garde Manger I - Salads and Sandwiches	2
CUL256	Advanced Garde Manger II - Appetizers and Hors d'Oeuvres ...	2
CUL265	Professional Baking I - Base Products and Sauces	2
CUL266	Professional Baking II - Breads and Rolls	2
CUL267	Professional Baking III - Pastries, Pies and Cakes	2
CUL268	Professional Baking IV - Decorative and Design Work	2

RESTRICTED ELECTIVES: 15 credits

CUL110	Food Service Nutrition	2
CUL140	Culinary Principles and Kitchen Management I	3
CUL180	Food in History	3
CUL190	Catering Operations I	3
CUL210	Menu Planning and Facilities Design	2
CUL240	Culinary Principles and Kitchen Management II	3
CUL296++	Cooperative Education (any module)	1-4
CUL298AC	Special Projects	3
HRM110	Introduction to Hospitality and Tourism Management	3
HRM150	Hospitality and Tourism Information Systems I	3
HRM230	Beverage Management	3
HRM275	Restaurant Management	3
HRM280	Hospitality and Tourism Law	3

GENERAL EDUCATION (G.E.) REQUIREMENTS: 25 credits

CORE: 15 credits

First-Year Composition

ENG101	First-Year Composition (3) OR	
ENG107	First-Year Composition for ESL (3) AND	
ENG102	First-Year Composition (3) OR	
ENG108	First-Year Composition for ESL (3)	6

Oral Communication

Any approved G. E. course from the Oral Communication area

Critical Reading

CRE101	Critical and Evaluative Reading I (3) OR equivalent as indicated	3
--------	---	---

Mathematics

Any approved G. E. course from the Mathematics area

DISTRIBUTION: 10 credits

Humanities and Fine Arts

Any approved G. E. course from the Humanities and Fine Arts area

Natural Sciences

Any approved G. E. course from the Natural Sciences area

Social and Behavioral Sciences

Any approved G. E. course from the Social/Behavioral Sciences area

Grade of "C" or better required for all courses in the AAS in Advanced Professional Culinary Arts.



**Make a
Reservation . . .**

Scottsdale Community College Programs

DANCE TECHNOLOGY

HPERD Division Office PE 155 (480) 423-6606
 Program Director, Patty Bodell PE 151 (480) 423-6600

The Dance Technology Program is designed for students who plan to enter the field of dance as performers, choreographers, teachers and dance technologists. Students will study dance theory, performance and production. They will receive hands-on training in multimedia production and the application of video and computer technology to dance.

CERTIFICATE OF COMPLETION IN DANCE TECHNOLOGY: 40-44 credits

PROGRAM NOTE: Students must enroll in one Ballet or Modern Dance technique class each semester.

REQUIRED COURSES: 31-35 credits

ADA/ART177	Computer-Photographic Imaging	3
DAH100	Introduction to Dance	3
DAN131	Ballet I (1) OR	
DAN134	Ballet II (1) OR	
DAN231AA	Ballet III: Intensive (2) OR	
DAN234AA	Ballet IV: Intensive (2)	2-4
DAN132	Modern Dance I (1) OR	
DAN135	Modern Dance II (1) OR	
DAN232	Modern Dance III (1) OR	
DAN235	Modern Dance IV (1) OR	
DAN232AA	Modern Dance III: Intensive (2) OR	
DAN235AA	Modern Dance IV: Intensive (2)	2-4
DAN210	Dance Production I	3
DAN221	Rhythmic Theory for Dance I	2
DAN241	Dance Notation I	3
DAN264	Choreography I	3
DAN272	Dance Technology	2
DAN280	Dance Practicum	2
MTC191	Electronic Music I	3
TCM100	Digital Multi Media	3

RESTRICTED ELECTIVES: 9 credits

ADA/ART175	Electronic Publishing Design I	3
ART100	Introduction to Computer Graphic Art	1
ART131	Photography I	3
ART150	Digital Storytelling (COM150/STO150)	3
DAH110	Dance in Film	3
DAN120++	World Dance (any modules)	1-2
DAN133	Modern Jazz Dance I (1) OR	
DAN136	Modern Jazz Dance II (1)	1
DAN138	Dance Seminar I	1
DAN140	Tap Dance I	1
DAN150	Dance Performance I	1-2
DAN211	Dance Production II	3
DAN233	Modern Jazz Dance III (1) OR	
DAN236	Modern Jazz Dance IV (1)	1
DAN233AA	Modern Jazz Dance III: Intensive (2) OR	
DAN236AA	Modern Jazz Dance IV: Intensive (2)	2
DAN238	Dance Seminar II	1
DAN267	Dance for Children	3
DAN/MUP285++	Multimedia Performance Ensemble (any module)	3
MKT210	Applied Marketing Strategies	3
TCM134	Pre-Production for Motion Picture and Television	3
TCM135	Production for Motion Picture and Television	3
TCM136	Post-Production for Motion Picture and Television	3

Grade of "C" or better required for all courses in the Certificate of Completion in Dance Technology.

DAN

AAS IN DANCE TECHNOLOGY: 62-68 credits

PROGRAM NOTE: Students must enroll in one Ballet or Modern Dance technique class each semester.

REQUIRED COURSES: 31-35 credits

ADA/ART177	Computer-Photographic Imaging	3
DAH100	Introduction to Dance	3
DAN131	Ballet I (1) OR	
DAN134	Ballet II (1) OR	
DAN231AA	Ballet III: Intensive (2) OR	
DAN234AA	Ballet IV: Intensive (2)	2-4
DAN132	Modern Dance I (1) OR	
DAN135	Modern Dance II (1) OR	
DAN232	Modern Dance III (1) OR	
DAN235	Modern Dance IV (1) OR	
DAN232AA	Modern Dance III: Intensive (2) OR	
DAN235AA	Modern Dance IV: Intensive (2)	2-4
DAN210	Dance Production I	3
DAN221	Rhythmic Theory for Dance I	2
DAN241	Dance Notation I	3
DAN264	Choreography I	3
DAN272	Dance Technology	2
DAN280	Dance Practicum	2
MTC191	Electronic Music I	3
TCM100	Digital Multi Media	3

RESTRICTED ELECTIVES: 9 credits

ADA/ART175	Electronic Publishing Design I	3
ART100	Introduction to Computer Graphic Art	1
ART131	Photography I	3
ART150	Digital Storytelling (COM150/STO150)	3
DAH110	Dance in Film	3
DAN120++	World Dance (any modules)	1-2
DAN133	Modern Jazz Dance I (1) OR	
DAN136	Modern Jazz Dance II (1)	1
DAN138	Dance Seminar I	1
DAN140	Tap Dance I	1
DAN150	Dance Performance I	1-2
DAN211	Dance Production II	3
DAN233	Modern Jazz Dance III (1) OR	
DAN236	Modern Jazz Dance IV (1)	1
DAN233AA	Modern Jazz Dance III: Intensive (2) OR	
DAN236AA	Modern Jazz Dance IV: Intensive (2)	2
DAN238	Dance Seminar II	1
DAN267	Dance for Children	3
DAN/MUP285++	Multimedia Performance Ensemble (any module)	3
MKT210	Applied Marketing Strategies	3
TCM134	Pre-Production for Motion Picture and Television	3
TCM135	Production for Motion Picture and Television	3
TCM136	Post-Production for Motion Picture and Television	3

GENERAL EDUCATION (G.E.) REQUIREMENTS: 22-24 credits

CORE: 15-17 credits

First-Year Composition

ENG101	First-Year Composition (3) OR	
ENG107	First-Year Composition for ESL (3) AND	
ENG102	First-Year Composition (3) OR	
ENG108	First-Year Composition for ESL (3)	6

Oral Communication

Any approved G. E. course from the Oral Communication area 3

Critical Reading

CRE101	Critical and Evaluative Reading I (3) OR equivalent as indicated by assessment.	3
--------	--	---

Mathematics

Any approved G. E. course from the Mathematics area 3-5

DISTRIBUTION: 7 credits

Humanities and Fine Arts

Met by DAH100 listed in the Required Courses area 0

Natural Sciences

Any approved G. E. course from the Natural Sciences area 4

Social and Behavioral Sciences

Any approved G. E. course from the Social/Behavioral Sciences area 3

Grade of "C" or better required for all courses in the AAS in Dance Technology.

Scottsdale Community College Programs

DRAFTING (ARCHITECTURAL TECHNOLOGY)

DFT

Applied Sciences Division Office AP 237B (480) 423-6599
 Program Director, Myron Brower AP 227 (480) 423-6229

Drafting and Computer-aided Drafting courses are administered through SCC's Architectural Technology Program. Please note: beginning Fall 2006, SCC will no longer offer courses with the DFT prefix. See the listing of courses under ARC.

See ARCHITECTURAL TECHNOLOGY (ARC), page 75.

EARLY CHILDHOOD DEVELOPMENT

CFS, ECH, EED, FCS, ITD

Social/Behavioral Sciences Division Office SB 130 (480) 423-6206
 Program Director, Dr. Rosanne Dlugosz SB 126 (480) 423-6204

The Early Childhood Development program is designed to prepare individuals to enter the workforce as Early Childhood Professionals and to assist individuals employed in the field to upgrade and expand their skills. There are wide differences in levels of training, education and certifications required for employment in this field within the state of Arizona and the nation.

Individuals employed or assisting in state licensed early childhood facilities must meet current regulatory standards. This may typically include fingerprinting checks, TB tests, immunizations, CPR/first aid training, and food handler training.

Teachers preparing for employment in Public School preschool and kindergarten classrooms will need an Arizona Early Childhood Teaching Certificate (which requires a four-year degree) or an Early Childhood Endorsement on their teaching certification. (See program and college advisors, and Arizona Department of Education website for information.) Private preschool and child care center personnel in Arizona are not required to have state teaching certificates at this time.

SCC offers an Associate in Applied Science in Early Childhood Development, an ATP degree (with Northern Arizona University), a Certificate of Completion in Early Childhood Development, and a Certificate of Completion in Infant/Toddler Development (see page 100). SCC also offers a related Certificate of Completion in Parent Education, and an Associate in Applied Science in Family Life Education (see page 92).

Selected courses in these programs are offered in the day session, but most will be offered in the evening, on weekends, or online formats. Courses are offered at SCC in rotation over several semesters. Some courses in this curriculum, taken at other Maricopa colleges, are transferable to SCC (see program advisor).

CERTIFICATE OF COMPLETION IN EARLY CHILDHOOD DEVELOPMENT: 30 credits

REQUIRED COURSES: 26 credits

ECH128	Early Learning: Play and the Arts	3
ECH176	Child Development (3) OR	3
EED 276	Global Child Development (3)	3
EED200	Foundations of Early Childhood Education	3
EED212	Guidance, Management and the Environment	3
EED215	Early Learning: Health, Safety, Nutrition and Fitness	3
EED220	Child, Family, Community and Culture	3
EED222	Introduction to the Exceptional Young Child	3
EED261	Early Childhood Preschool Internship (1)	2
EED278	Early Learning: Curriculum and Instruction	3

RESTRICTED ELECTIVES: 4 credits

CFS181	Enhancing Infant and Toddler Development	3
CFS/ECH120	Contemporary Issues in Early Childhood	1
ECH126AB	Play Lab-Toddlers	1
ECH237	Media for Young Children	1
ECH272	Science for the Young Child	1
ECH273	Math for the Young Child	1
ECH276	Musical Beginnings	1
ITD205	Emerging Individuality	1

Grade of "C" or better required for all courses in the Certificate of Completion in Early Childhood Development.

AAS IN EARLY CHILDHOOD DEVELOPMENT: 64-66 credits

REQUIRED COURSES: 35 credits

ECH128	Early Learning: Play and the Arts	3
EED200	Foundations of Early Childhood Education	3
EED212	Guidance, Management and the Environment	3
EED220	Child, Family, Community and Culture	3
EED222	Introduction to the Exceptional Young Child	3
EED250	Early Literacy Development	3
EED255	Portfolio Development and Writing for the Profession	3
EED278	Early Learning: Curriculum and Instruction	3
EED280	Standards, Observation & Assessment in Early Education (3) OR	3
CFS181	Enhancing Infant and Toddler Development (3)	3
ITD205	Emerging Individuality	1

Students must select from the following courses for a total of 4 credits:

EED260	Early Childhood Infant/Toddler Internship (1)	2
EED261	Early Childhood Preschool Internship (1)	2-4

RESTRICTED ELECTIVES: 4 credits

CFS181	Enhancing Infant and Toddler Development	3
CFS/ECH120	Contemporary Issues in Early Childhood	1
ECH126AB	Play Lab-Toddlers	1
ECH/ITD183	Infant/Toddler Learning Materials	1
ECH237	Media for Young Children	1
ECH272	Science for the Young Child	1
ECH273	Math for the Young Child	1
ECH276	Musical Beginnings	1
ECH296WB	Cooperative Education	2
EED280	Standards, Observation & Assessment in Early Education	3

GENERAL EDUCATION (G.E.) REQUIREMENTS: 25-27 credits

CORE: 15-17 credits

First-Year Composition

ENG101	First-Year Composition (3) OR	
ENG107	First-Year Composition for ESL (3) AND	
ENG102	First-Year Composition (3) OR	
ENG108	First-Year Composition for ESL (3)	6

Oral Communication

Any approved G.E. course from the Oral Communication area 3

Critical Reading

CRE101	Critical and Evaluative Reading I (3) OR	3
	equivalent as indicated by assessment.	

Mathematics

Any approved G. E. course from the Mathematics area 3-5

DISTRIBUTION: 10 credits

Humanities and Fine Arts

EDU/ENH291	Children's Literature	3
------------	-----------------------------	---

Natural Sciences

Any approved G. E. course from the Natural Sciences area 4

Social and Behavioral Sciences

CFS/ECH176	Child Development	3
------------	-------------------------	---

Grade of "C" or better required for all courses in the AAS in Early Childhood Development.

Scottsdale Community College Programs

EMERGENCY MEDICAL TECHNOLOGY

EMT

Health Sciences Division Office SB 132 (480) 423-6225

The Division of Health Sciences offers a Certificate of Completion in Basic Emergency Medical Technology, a Certificate of Completion in Advanced Emergency Medical Technology (Paramedic), and an Associate in Applied Science in Advanced Emergency Medical Technology.

Students will be awarded a Certificate of Completion in Basic Emergency Medical Technology upon completion of EMT104 with a grade of C or better. Satisfactory completion of the course will also qualify students to take the Department of Health Services State Certification exam for EMT-Basic.

A Certificate of Completion in Advanced Emergency Medical Technology (Paramedic) provides specialized paramedic training for those who have completed the Basic EMT Certificate program. Prior to entry into the advanced program, the student must have been actively practicing as a State Certified Basic Emergency Medical Technician for one year and be selected by a written examination and oral interview.

The program of study for an Associate in Applied Science in Advanced Emergency Medical Technology (Paramedic) combines the EMT training included in the Advanced Certificate with general studies. Prior to entry into the advanced program, the student must have been actively practicing as a State Certified Basic Emergency Medical Technician for one year and be selected by a written examination and oral interview.

CERTIFICATE OF COMPLETION IN BASIC EMERGENCY

MEDICAL TECHNOLOGY: 8 credits

PROGRAM PREREQUISITES: CRE101 or CRE111 or equivalent as indicated by assessment.

EMT104 Basic Emergency Medical Technology (FSC104) 8
Grade of "C" or better required for all courses in the Certificate of Completion in Basic Emergency Medical Technology.

CERTIFICATE OF COMPLETION IN ADVANCED EMERGENCY

MEDICAL TECHNOLOGY (PARAMEDIC): 51.5 credits

ADMISSION CRITERIA: Students must be actively practicing as a State Certified Basic Emergency Medical Technician for one year and be selected by a written examination and oral interview.

PROGRAM PREREQUISITES: 15 credits

BIO100 Biology Concepts (4) OR
BIO102 General Biology (Non-Majors) Additional Topics (4) OR
BIO160 Introduction to Human Anatomy and Physiology (4) OR
BIO181 General Biology (Majors) I (4) 4
CRE101 Critical and Evaluative Reading I (3) OR
CRE111 Critical Reading for Business and Industry (3) 3
Basic Emergency Medical Technology Certification (EMT) 8

REQUIRED COURSES: 45.5 credits

EMT235 Emergency Cardiac Care 3
EMT236 Pharmacology in an Emergency Setting 3
EMT238 Vehicular Extrication and Patient Stabilization (FSC238) 2
EMT240 Advanced Cardiac Life Support 2
EMT242 Pediatric Advanced Life Support 1
EMT245 Trauma Management I 2
EMT272AA Advanced Emergency Medical Technology (12.5) AND
EMT272AB Advanced Emergency Medical Technology (12.5) 25
EMT272LL Advanced Emergency Medical Technology Practicum 7.5

RESTRICTED ELECTIVES: 6 credits

BIO201 Human Anatomy and Physiology I 4
BIO202 Human Anatomy and Physiology II 4
EMT208 Intermediate Emergency Medical Technology 16
EMT215 Stress and Emergency Services Professionals 3
EMT246 Trauma Management II 4
PSY266 Abnormal Psychology 3

Grade of "C" or better required for all courses in the Certificate of Completion in Advanced Emergency Medical Technology (Paramedic).

AAS IN ADVANCED EMERGENCY

MEDICAL TECHNOLOGY (PARAMEDIC): 71.5-73.5 credits

ADMISSION CRITERIA: Students must be actively practicing as a State Certified Basic Emergency Medical Technician for one year and be selected by a written examination and oral interview.

PROGRAM PREREQUISITES: 15 credits

BIO100 Biology Concepts (4) OR
BIO102 General Biology (Non-Majors) Additional Topics (4) OR
BIO160 Introduction to Human Anatomy and Physiology (4) OR
BIO181 General Biology (Majors) I (4) 4
CRE101 Critical and Evaluative Reading I (3) OR
CRE111 Critical Reading for Business and Industry (3) 3
Basic Emergency Medical Technology Certification (EMT) 8

REQUIRED COURSES: 45.5 credits

EMT235 Emergency Cardiac Care 3
EMT236 Pharmacology in an Emergency Setting 3
EMT238 Vehicular Extrication and Patient Stabilization (FSC238) 2
EMT240 Advanced Cardiac Life Support 2
EMT242 Pediatric Advanced Life Support 1
EMT245 Trauma Management I 2
EMT272AA Advanced Emergency Medical Technology (12.5) AND
EMT272AB Advanced Emergency Medical Technology (12.5) 25
EMT272LL Advanced Emergency Medical Technology Practicum 7.5

RESTRICTED ELECTIVES: 8 credits

BIO201 Human Anatomy and Physiology I 4
BIO202 Human Anatomy and Physiology II 4
EMT208 Intermediate Emergency Medical Technology 16
EMT215 Stress and Emergency Services Professionals 3
EMT246 Trauma Management II 4
PSY266 Abnormal Psychology 3

GENERAL EDUCATION (G.E.) REQUIREMENTS: 18-20 credits

CORE: 12-14 credits

First-Year Composition

ENG101 First-Year Composition (3) AND
ENG102 First-Year Composition (3) 6

Oral Communication

Any approved G. E. course from the Oral Communication area 3

Critical Reading

Met by CRE101 or CRE111 in Program Prerequisites area 0

Mathematics

Any approved G. E. course from the Mathematics area 3-5

DISTRIBUTION: 6 credits

Humanities and Fine Arts

Any approved G. E. course from the Humanities and Fine Arts area 3

Natural Sciences

Met by BIO100, BIO102, BIO160 or BIO181 in Prerequisites area 0

Social and Behavioral Sciences

PSY101 Introduction to Psychology 3

Grade of "C" or better required for all courses in the AAS in Advanced Emergency Medical Technology (Paramedic).

Scottsdale Community College Programs

ENGINEERING SCIENCE

Physical Science Department Office PS 153 (480) 423-6111
ECE Course Coordinator, Dr. Kyle Rawlings .. PS 151 (480) 423-6166

Engineering majors are advised to take a math course each semester upon entering Scottsdale Community College and to take chemistry and physics courses as soon as math skills are adequate. In addition, students are advised to defer some general studies requirements (humanities, social sciences, etc.) until after transfer to a university. The reasons for these recommendations are twofold: it is important to establish a firm foundation in mathematics and the sciences as quickly as possible, and the deferred general studies courses will provide balance in your university curriculum when taking upper division, specialized engineering courses.

The following recommended list of math and science courses for engineering majors is arranged in sequence. The list suggests a possible three-year plan of study; each student should get advisement regarding their particular engineering major. Generally, science and engineering courses are positioned on the list so as to coordinate with math prerequisites. Contact the Course Coordinator for advice regarding particular needs.

Mathematics	Engineering	Chemistry, Lab	Physics
MAT122	—	CHM130, 130LL	—
MAT151	ECE102	CHM151, 151LL	—
MAT182	ECE103	CHM152, 152LL	—
MAT220	—	—	PHY111
MAT230	—	—	PHY121
MAT240	ECE211	—	PHY131
MAT261	ECE212	—	PHY252

EQUINE SCIENCE

Applied Sciences Division Office AP 237B (480) 423-6599
Program Director, Diane Blazer AP 229 (480) 423-6231

The Equine Science program is designed to offer a broad-based educational background for students who wish to enter the horse industry job market or transfer to a four-year equine science program. An Associate in Applied Science (AAS) in Equine Science will be awarded upon satisfactory completion of the outlined program. A Certificate of Completion in Equine Science is also offered. Community participants may enroll in individual classes with a Pass/Fail grade option, if desired.

CERTIFICATE OF COMPLETION IN EQUINE SCIENCE: 42 credits

REQUIRED COURSES: 36 credits

BPC110	Computer Usage and Applications	3
EQS105	Principles of Equine Science	3
EQS120	Equine Anatomy and Physiology	3
EQS130	Equine Business and Law	3
EQS140	Equine Behavior	3
EQS200	Principles of Equine Nutrition	3
EQS215	Feeding Programs for Production and Performance	3
EQS220	Equine Reproduction	3
EQS225	Equine Health and Disease Management	3
EQS250	Equine Evaluation	3
EQS280	Equine Science Internship	2
EQS282	Special Event Internship	1
MGT253	Owning and Operating a Small Business	3

ECE

RESTRICTED ELECTIVES: 6 credits

EQS160	English Horsemanship I	3
EQS165	Western Horsemanship I	3
EQS175	Introduction to Equine Massage	3
EQS180	English Horsemanship II	3
EQS185	Western Horsemanship II	3
MGT251	Human Relations in Business	3
PSY250	Social Psychology	3
SPA115	Beginning Spanish Conversation I	3

Grade of "C" or better required for all courses in the Certificate of Completion in Equine Science.

AAS IN EQUINE SCIENCE: 67-69 credits

REQUIRED COURSES: 36 credits

BPC110	Computer Usage and Applications	3
EQS105	Principles of Equine Science	3
EQS120	Equine Anatomy and Physiology	3
EQS130	Equine Business and Law	3
EQS140	Equine Behavior	3
EQS200	Principles of Equine Nutrition	3
EQS215	Feeding Programs for Production and Performance	3
EQS220	Equine Reproduction	3
EQS225	Equine Health and Disease Management	3
EQS250	Equine Evaluation	3
EQS280	Equine Science Internship	2
EQS282	Special Event Internship	1
MGT253	Owning and Operating a Small Business	3

RESTRICTED ELECTIVES: 6 credits

EQS160	English Horsemanship I	3
EQS165	Western Horsemanship I	3
EQS175	Introduction to Equine Massage	3
EQS180	English Horsemanship II	3
EQS185	Western Horsemanship II	3
MGT251	Human Relations in Business	3
PSY250	Social Psychology	3
SPA115	Beginning Spanish Conversation I	3

GENERAL EDUCATION (G.E.) REQUIREMENTS: 25-27 credits

CORE: 15-17 credits

First-Year Composition

ENG101	First-Year Composition (3) OR	
ENG107	First-Year Composition for ESL (3) AND	
ENG102	First-Year Composition (3) OR	
ENG108	First-Year Composition for ESL (3)	6

Oral Communication

Any approved G. E. course from the Oral Communication area

3

Critical Reading

CRE101	Critical and Evaluative Reading I (3) OR equivalent as indicated by assessment.	3
--------	---	---

Mathematics

Any approved G. E. course from the Mathematics area

3-5

DISTRIBUTION: 10 credits

Humanities and Fine Arts

Any approved G. E. course from the Humanities and Fine Arts area

3

Natural Sciences

Any approved G. E. course from the Natural Sciences area

4

Social and Behavioral Sciences

PSY101 Introduction to Psychology

3

Grade of "C" or better required for all courses in the AAS in Equine Science.

Scottsdale Community College Programs

FAMILY LIFE EDUCATION

Social/Behavioral Sciences Division Office SB 130 (480) 423-6206
 Program Director, Dr. Rosanne Dlugosz SB 126 (480) 423-6204

The Family Life Education program prepares individuals to enter the family life education, human development, or child and family organizations field at the paraprofessional level. Students at a paraprofessional level can expect to find employment opportunities in adoption and foster care, adult day care centers, crisis intervention programs, group and halfway houses, hospice care, senior citizen centers, social service agencies (both private and state/local government), facilities for the disabled and developmentally challenged individuals, community mental health clinics, psychiatric facilities, shelters and other child and family, community-based organizations.

In addition to an Associate in Applied Science in Family Life Education, the program also offers a Certificate of Completion in Parent Education.

Family Life Education is a shared program offered at several Maricopa campuses. Only the Parent Education Certificate and the AAS degree will be offered at SCC at this time. Other 12-credit block concentrations within the AAS degree (Adolescent Development; Adult Development & Aging; Child and Family Organizations, Management and Administration) may be completed within the district. See program director for further information.

CERTIFICATE OF COMPLETION IN PARENT EDUCATION: 19 credits

REQUIRED COURSES: 19 credits

BPC110	Computer Usage and Applications (3) OR	
CIS105	Survey of Computer Information Systems (3)	3
CFS190	Home-Based Visitation	3
CFS220	Introduction to Parenting and Family Development	3
CFS225	Foundations of Parent Education	3
CFS243	Cross-Cultural Parenting (3) OR	
EED276	Global Child Development (3)	3
FCS250	Portfolio Development and Professional Writing	3
FCS260	Family and Consumer Science Internship	1

Grade of "C" or better required for all courses in the Certificate of Completion in Parent Education.

CFS, EED, FCS

AAS IN FAMILY LIFE EDUCATION: 65 credits

REQUIRED COURSES: 40 credits

BPC110	Computer Usage and Applications (3) OR	
CIS105	Survey of Computer Information Systems (3)	3
CFS205	Human Development	3
CFS210	Family Life Education	3
CFS250	Social Policy and Families	3
CFS258	Families in Society	3
CFS259	Sexuality over the Life Span	3
CFS240	Human Behavior in Context	3
FCS250	Portfolio Development and Professional Writing	3
FCS260	Family and Consumer and Science Internship	1
FON100	Introductory Nutrition	3

Note – Students must complete one of the following four blocks:

BLOCK ONE – Parent Education: 12 credits

CFS190	Home-Based Visitation	3
CFS220	Introduction to Parenting and Family Development	3
CFS225	Foundations of Parent Education	3
CFS243	Cross-Cultural Parenting (3) OR	
EED276	Global Child Development (3)	3

BLOCK TWO – Adolescent Development: 12 credits

CFS183	Contemporary Issues in Adolescence	3
CFS249	Transition to Adulthood	3
CFS277	Adult-Adolescent Interaction	3
PSY101	Introduction to Psychology	3

BLOCK THREE – Adult Development & Aging: 12 credits

CFS247	Family Ties and Aging	3
CFS249	Transition to Adulthood	3
CFS251	Transitions: Work to Retirement	3
CFS252	Contemporary Issues in Aging	3

BLOCK FOUR – Child and Family Organizations: Management and Administration: 12 credits

CFS206	Child/Family Organizations: Management/Administration	3
CFS207	Organization/Community Leadership in Child/Family Org.	3
CFS208	Child/Family Organizations: Fiscal Mgmt & Grant Writing	3
CFS209	Child/Family Organizations: Project Management	3

GENERAL EDUCATION (G.E.) REQUIREMENTS: 25 credits

CORE: 15 credits

First-Year Composition

ENG101	First-Year Composition (3) AND	
ENG102	First-Year Composition (3)	6

Oral Communication

COM110	Interpersonal Communication	3
--------	-----------------------------------	---

Critical Reading

CRE101	Critical and Evaluative Reading I	3
--------	---	---

Mathematics

MAT102	Mathematical Concepts/Applications (3) OR	
MAT122	Intermediate Algebra (3) OR	
	Equivalent as indicated by assessment OR	
	A higher level math course	3

DISTRIBUTION: 10 credits

Humanities and Fine Arts

	Any approved G. E. course from the Humanities and Fine Arts area	3
--	--	---

Natural Sciences

	Any approved G. E. course from the Natural Sciences area	4
--	--	---

Social and Behavioral Sciences

CFS157	Marriage and Family Life	3
--------	--------------------------------	---

Grade of "C" or better required for all courses in the AAS in Family Life Education.

Scottsdale Community College Programs

FIRE SCIENCE TECHNOLOGY

Health Sciences Division Office SB 132 (480) 423-6225

The Fire Science Curriculum is designed for students who desire advanced training as professional firefighters, basic preparation courses for a career in fire science, or a better understanding of fire hazards and problems in the field. Completion of the two-year program will qualify students for the Associate in Applied Science in Fire Science Technology. A 36-credit Certificate of Completion in Fire Science Technology is also offered.

The Certificate of Completion in Fire Academy provides the opportunity for non-sponsored fire department employees and community-based consumers to acquire a certificate in a college-based Certified Fire Academy. Students interested in applying for the CCL in Fire Academy must have completed the prerequisite courses, attend a campus information meeting and submit an application. For more information, please call the Division of Health Sciences Office at (480) 423-6225.

CERTIFICATE OF COMPLETION IN FIRE ACADEMY: 11 credits

PROGRAM PREREQUISITES: 14 credits

EMT/FSC104	Basic Emergency Medical Technology	8
	NOTE: EMT/FSC104 requires a grade of B or better.	
FSC105	Hazardous Materials/First Responder	3
	NOTE: FSC105 requires a grade of C or better.	
FSC134	Fitness and Conditioning for Firefighters	3
	NOTE: FSC134 requires a grade of A AND passing of the physical exam.	

REQUIRED COURSES: 11 credits

FSC102	Fire Department Operations	11
--------	----------------------------------	----

CERTIFICATE OF COMPLETION IN FIRE SCIENCE TECHNOLOGY: 36 credits

NOTE: Not all Fire Science (FSC) courses are offered every semester.

REQUIRED COURSES: 36 credits

FSC105	Hazardous Materials/First Responder	3
FSC106	Introduction to Fire Protection	3
FSC108	Fundamentals of Fire Prevention	3
FSC113	Introduction to Fire Suppression	3
FSC117	Fire Apparatus	3
FSC118	Fire Hydraulics	3
FSC202	Supervisory Training for Firefighters	3
FSC204	Firefighting Tactics and Strategy	3
FSC208	Firefighter Safety and Building Construction	3
COM+++++	Any approved G. E. course from the Oral Communication area	3
ENG101	First-Year Composition (3) OR	
ENG107	First-Year Composition for ESL (3)	3
MAT102	Mathematical Concepts/Applications	3

Grade of "C" or better required for all courses in the Certificate of Completion in Fire Science Technology.

FSC

AAS IN FIRE SCIENCE TECHNOLOGY: 65-67 credits

REQUIRED COURSES: 27 credits

FSC105	Hazardous Materials/First Responder	3
FSC106	Introduction to Fire Protection	3
FSC108	Fundamentals of Fire Prevention	3
FSC113	Introduction to Fire Suppression	3
FSC117	Fire Apparatus	3
FSC118	Fire Hydraulics	3
FSC202	Supervisory Training for Firefighters	3
FSC204	Firefighting Tactics and Strategy	3
FSC208	Firefighter Safety and Building Construction	3

RESTRICTED ELECTIVES: 14 credits

EMT/FSC104	Basic Emergency Medical Technology	8
FSC102	Fire Department Operations	11
FSC209	Fire Investigation	3
FSC211	Fundamentals of Flammable Hazardous Materials	3
FSC296WC	Cooperative Education	3
GBS205	Legal, Ethical, and Regulatory Issues in Business	3
MGT127	Managing and Leading for Competitive Advantage	3

GENERAL EDUCATION (G.E.) REQUIREMENTS: 24-26 credits

CORE: 15-17 credits

First-Year Composition

Any approved G. E. course from the First-Year Composition area	6
--	---

Oral Communication

Any approved G. E. course from the Oral Communication area	3
--	---

Critical Reading

CRE101	Critical and Evaluative Reading I (3) OR Equivalent by assessment.	3
--------	--	---

Mathematics

Any approved G. E. course from the Mathematics area	3-5
---	-----

DISTRIBUTION: 9 credits

Humanities and Fine Arts

Any approved G. E. course from the Humanities and Fine Arts area	2
--	---

Natural Sciences

CHM130	Fundamental Chemistry	3
CHM130LL	Fundamental Chemistry Lab	1

Social and Behavioral Sciences

PSY101	Introduction to Psychology	3
--------	----------------------------------	---

Grade of "C" or better required for all courses in the AAS in Fire Science Technology.

Scottsdale Community College Programs

FITNESS/NUTRITION

HPERD Division Office PE 148 (480) 423-6685
 Program Contact, Amy Goff PE 148 (480) 423-6685

The Strength and Conditioning Personal Trainer certificate prepares students for employment in the fitness industry as Strength and Conditioning Personal Trainers/Coaches. This curriculum provides students with a fundamental knowledge of human physiology and anatomy, prevention and treatment of exercise related injuries, emergency response readiness, health appraisals and assessments; application of exercise fitness principles and strength training techniques; a fundamental knowledge of nutrition, weight control, stress management and exercise physiology, and biomechanics; skills in exercise testing and fitness measures as well as writing exercise prescriptions and program designs for diverse populations.

HES, PED

CERTIFICATE OF COMPLETION IN

STRENGTH AND CONDITIONING PERSONAL TRAINER: 31 credits

REQUIRED COURSES: 31 credits

BIO160	Introduction to Human Anatomy and Physiology	4
HES100	Healthful Living	3
HES154	First Aid/Cardiopulmonary Resuscitation	3
HES271	Prevention and Treatment of Athletic Injuries	3
PED112	Professional Applications of Fitness Principles	3
PED125	Exercise Science	3
PED130	Strength Fitness-Physiological Principles and Training Techniques ..	3
PED145	Guidelines for Exercise Testing and Prescription	3
PED275	Methods of Enhancing Physical Performance	3
PED285	Exercise Program Design and Instruction	3

Grade of "C" or better required for all courses in the Certificate of Completion in Strength and Conditioning Personal Trainer.

GRAPHIC DESIGN

Fine Arts Division Office MB 139 (480) 423-6328
 Program Director, Rachel Woodburn AB 109A (480) 423-6338

The Certificate of Completion and Associate in Applied Science in Graphic Design are designed for students who plan to enter the field of Design. Students will receive hands-on training in fine art foundations, design principles, and in computer-generated design including layout, illustrations, typeface, color principles, photographic manipulation, and prepress ready graphic design.

ART

CERTIFICATE OF COMPLETION IN

GRAPHIC DESIGN: 38 credits

REQUIRED COURSES: 30 credits

ADA/ART112	Two-Dimensional Design	3
ADA/ART169	Two-Dimensional Computer Design	3
ADA/ART175	Electronic Publishing Design I	3
ADA/ART177	Computer-Photographic Imaging	3
ARH100	Introduction to Art	3
ART100	Introduction to Computer Graphic Art	1
ART103	Typography in the Digital Age	3
ART113	Color	3
ART181	Graphic Design I	3
ART255AA	Self Promotion	1
ART255AB	The Portfolio	1
ART291	Digital Prepress	3

RESTRICTED ELECTIVES: 8 credits

ADA/ART183	Computer Aided Graphic Arts I	3
ART142	Introduction to Digital Photography	3
ART150	Digital Storytelling (COM/STO150)	3
ART182	Graphic Design II	3
ART/MMT190	Art of Web Site Design	3
ART289	Computer Illustration	3
ART296WA-WD	Cooperative Education (any module)	1-4
BPC/CIS133DA	Internet/Web Development - Level I	3

Grade of "C" or better required for all courses in the Certificate of Completion in Graphic Design.

ASSOCIATE IN APPLIED SCIENCE IN

GRAPHIC DESIGN: 63-65 credits

REQUIRED COURSES: 30 credits

ADA/ART112	Two-Dimensional Design	3
ADA/ART169	Two-Dimensional Computer Design	3
ADA/ART175	Electronic Publishing Design I	3
ADA/ART177	Computer-Photographic Imaging	3
ARH100	Introduction to Art	3
ART100	Introduction to Computer Graphic Art	1
ART103	Typography in the Digital Age	3
ART113	Color	3
ART181	Graphic Design I	3
ART255AA	Self Promotion	1
ART255AB	The Portfolio	1
ART291	Digital Prepress	3

RESTRICTED ELECTIVES: 11 credits

ADA/ART183	Computer Aided Graphic Arts I	3
ART142	Introduction to Digital Photography	3
ART150	Digital Storytelling (COM/STO150)	3
ART182	Graphic Design II	3
ART/MMT190	Art of Web Site Design	3
ART289	Computer Illustration	3
ART296WA-WD	Cooperative Education (any module)	1-4
BPC/CIS133DA	Internet/Web Development - Level I	3

GENERAL EDUCATION (G.E.) REQUIREMENTS: 22-24 credits

CORE: 15-17 credits

First-Year Composition

Any approved G. E. courses from the First-Year Composition area 6

Oral Communication

Any approved G. E. courses from the Oral Communication area 3

Critical Reading

CRE101 Critical and Evaluative Reading I (3) OR
 Equivalent as indicated 3

Mathematics

Any approved G. E. course from the Mathematics area 3-5

DISTRIBUTION: 7 credits

Humanities and Fine Arts

Met by ARH100 in Required Courses area 0

Natural Sciences

Any approved G. E. course from the Natural Sciences area 4

Social and Behavioral Sciences

Any approved G. E. course from the Social/Behavioral Sciences area 3

Grade of "C" or better required for all courses in the AAS in Graphic Design.

Scottsdale Community College Programs

HEALTH CARE INTEGRATED EDUCATIONAL SYSTEM (HCIES)

Health Sciences Division Office SB 132 (480) 423-6225

In collaboration and partnership with the health care community and its response to the dynamic changes occurring in the health care arena and health care professions' practice, the Maricopa Community Colleges integrated the curriculum of all allied health and nursing programs. All HCIES program pathways and educational offerings emphasize the achievement of relevant competencies and provide value to the individual, the employer, and the community. As a result, graduates of the various HCIES program pathways will meet the community's demand for a flexible, multi-skilled health care workforce that meets employer and consumer needs. Refer to individual college catalogs for specific health care program pathways. For further information, <http://healthcare.maricopa.edu> is a comprehensive information source.

HCIES Assumption of Risk/Release of Liability

Most of the program pathways of the HCIES include a program of study in a clinical training environment which may contain exposures to risks inherent in patient-oriented educational experiences such as, but not limited to, bodily injury or communicable and infectious diseases. Students enrolling in clinical educational courses will be asked to sign a statement assuming all risks inherent in their coursework.

Use of Confidential Information

Students enrolled in program pathways of the HCIES will have learning experiences in a health care setting where they will have access to confidential information. Prior to beginning any clinical studies, the students will be asked to sign an agreement to adhere to the requirements of those clinical sites and applicable law, including the Health Insurance Portability and Accountability Act of 1996 (HIPAA).

HCIES College of Attendance

As the programs within the HCIES are integrated across the Maricopa Community College District, college of attendance requirements for the completion of the health care program pathways can be met through the completion of coursework taken at all the Maricopa Community Colleges and Skill Centers.

Requirement of Background Check

Students enrolled in most of the HCIES pathways will be in clinical learning experiences, working with children, elderly persons, and other vulnerable populations. Arizona State law and healthcare agency policies require evidence of clear background checks prior to entering such learning experiences. Students seeking admission to some health programs will be required to provide a current Fingerprint Clearance Card at the time of application to or enrollment in clinical courses, according to program guidelines. The Fingerprint Clearance Card must remain in effect for the duration of time of program enrollment. It is advised that students carry proof of the clearance at all times during any agency learning experience.

Note: Even though the Fingerprint Clearance Card is valid for 6 years, certain State licensing boards may require a new background check or clearance card upon request for State licensure or certification.

Waiver of Licensure/Certificate Guarantee

Many of the HCIES programs prepare graduates for application for State or National certificates or licenses. In some professions, such licensure and certification is required prior to employment or practice in the profession. Graduation from a HCIES program does not guarantee the receipt of a license or certificate to practice in the field of study.

MCCCD Health Care Integrated Educational System

To respond to the dynamic changes occurring in health care arena and health professions' practice, the MCCCD has integrated the curriculum of all allied health and nursing programs and identified common, shared, or program competencies for specific Health Care pathways.

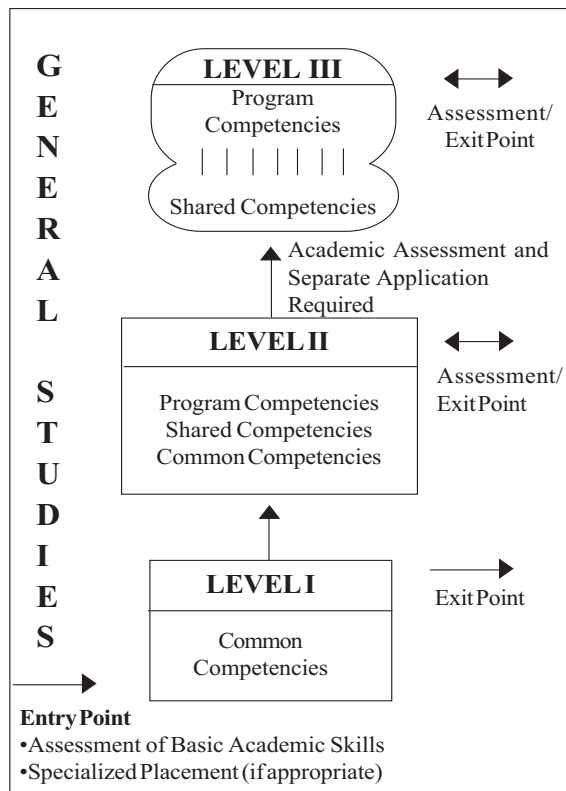

Notes:

1. Students are responsible for completing General Studies coursework required for their particular Health Care Pathway.
2. All students must successfully demonstrate required reading, writing, and mathematics competencies. Academic remediation is available.
3. It may be possible for some students to meet Health Care Competency requirements for Level I and Level II common competencies through assessment of prior experience and/or education.
4. Completion of Level I and Level II does not guarantee admission into Level III Health Care Pathways.

Chandler Gilbert (CGCC), Estrella Mountain (EMCC), GateWay (GWCC), Glendale (GCC), Mesa (MCC), Phoenix (PC), Paradise Valley (PVCC), Rio Salado (RSC), Scottsdale (SCC), South Mountain (SMCC), and the Maricopa Skill Center (MSC) and the Southwest Skill Center at EMCC (SWSC/EMCC) offer health care courses. Not all courses are offered at all sites. Please contact the specific college for more information regarding the availability of courses and course schedule information.

Continued next page...

Scottsdale Community College Programs

LEVEL I – Common Competencies 2.0 Credits

ALL Health Care Students must satisfactorily achieve the Level I Common Competencies found in the following courses.

HCC130AA	Health Care Today	0.5
HCC130AB	Workplace Behavior in Health Care	0.5
HCC130AC	Personal Wellness and Safety	0.5
HCC130AD	Communication/Teamwork in Health Care Organizations ...	0.5

LEVEL II – Common Competencies Credits Vary

ALL Health Care Students must satisfactorily achieve the Level II Common Competencies. See your advisor for which Medical Terminology course satisfies your pathway's course requirements.

HCC130AE	Legal and Ethical Issues in Health Care	0.5
HCC130AF	Decision Making in the Health Care Setting	0.5
HCC145AA	Medical Terminology for Health Care Workers I	1.0
HCC145AB	Medical Terminology for Health Care Workers II	1.0
HCC145AC	Medical Terminology for Health Care Workers III	1.0

LEVEL II – Shared and Program Competencies Credits Vary

Required of only certain health occupations program pathways. Refer to specific program pathway curriculum or check with a program advisor. Shared Competencies are shared by several health program pathways. Program competencies are specific to individual health occupations program pathways.

LEVEL III – Shared and Program Competencies* Credits Vary

Shared Competencies are shared by several Health Care Pathways. Program Competencies are specific to individual Health Care Pathways. These are required for certain Health Occupations Program Pathways. Refer to specific Pathway requirements or check with an advisor.

*Certain Health Care Pathways require satisfactory achievement of all Level I and II Common Competencies prior to being admitted and registering for courses in Level III. Admission into Level III Health Care Pathways is based on meeting additional requirements and involves a separate admission process. See your advisor for more information.

Level II Health Care Pathways Examples**

Clinical Research Coordinating (GWCC)
 Community Health Advocate for Diabetes (MCC)
 Dental Assisting (PC, RSC)
 Dental Office Management (PC)
 Diagnostic Medical Ultrasound (GWCC)
 Direct Care Practice (MCC)
 Health Information Technology (PC)
 Health Services Management (GWCC)
 Health Unit Coordinating (GWCC)
 Histology Technician (PC)
 Hospital Central Service (GWCC)
 Laboratory Assisting (PC)
 Medical Assisting (MSC, PC, SWSC/EMCC)
 Medical Billing (PC)
 Med. Coding: Physician/Hospital Based (PC)
 Med. Transcription (GWCC, SWSC/EMCC)
 Nuclear Medicine Technology (GWCC)
 Nurse Assisting (GCC, GWCC, MCC, MSC, PC, PVCC, RSC, SCC, SWSC/EMCC)
 Patient Care Technician (PC)
 Perioperative Nursing (GWCC)
 Phlebotomy (PC)
 Surgical Technician First Assistant (GWCC)
 Surgical Technology (GWCC)
 Teaching Healing Meditation and Stress Management (PVCC)
 Therapeutic Massage (CGCC, PC)

**subject to change

Level III Health Care Pathways Examples**

Dental Hygiene (PC, RSC)
 Dental Office Management (PC)
 Diagnostic Medical Ultrasound (GWCC)
 Direct Care Practice (MCC)
 Health Information Technology (PC)
 Histology Technician (PC)
 Medical Assisting (MSC, PC, SWSC/EMCC)
 Medical Radiography (GWCC)
 Nuclear Medicine Technology (GWCC)
 Nursing (GWCC, SWSC/EMCC)
 Nuclear Medicine Technology (GWCC)
 Nursing (GCC, GWCC, MCC, PC, PVCC, RSC, SCC)
 Physical Therapist Assisting (GWCC)
 Practical Nursing (GCC, GWCC, MCC, MSC, PC, PVCC, RSC, SCC, SWSC/EMCC)
 Health Services Management (GWCC)
 Respiratory Care (GWCC)
 Surgical Technology (GWCC)
 Therapeutic Massage (CGCC, PC)

Scottsdale Community College Programs

HEALTH, PHYSICAL EDUCATION, RECREATION AND DANCE

PED

HPERD Division Office PE 106 (480) 423-6606

The course work offered in the Health, Physical Education, Recreation and Dance Department will assist students interested in majoring in exercise science, wellness, teaching, coaching, recreation, dance, and other health-related fields. Since each college or university has specific transfer requirements, you will need to consult the catalog of the college or university of your choice. An advisor or the appropriate faculty member of the HPERD Department will be able to assist you in developing a course of study that will lead to a degree in one of the major fields of study.

HPERD course offerings at SCC:

DAH100	Introduction to Dance	3
DAH110	Dance in Film	3
DAH201	World Dance Perspectives	3
DAN115	Contemporary Dance Trends	1
DAN131	Ballet I	1
DAN132	Modern Dance I	1
DAN133	Modern Jazz Dance I	1
DAN134	Ballet II	1
DAN135	Modern Dance II	1
DAN136	Modern Jazz Dance II	1
DAN138	Dance Seminar I	1
DAN140	Tap Dance I	1
DAN211	Dance Production II	3
DAN221	Rhythmic Theory for Dance I	2
DAN231AA	Ballet III: Intensive	2
DAN232	Modern Dance III	1
DAN232AA	Modern Dance III: Intensive	2
DAN233	Modern Jazz Dance III	1
DAN233AA	Modern Jazz Dance III: Intensive	2
DAN234AA	Ballet IV: Intensive	2
DAN235	Modern Dance IV	1
DAN235AA	Modern Dance IV: Intensive	2
DAN236	Modern Jazz Dance IV	1
DAN236AA	Modern Jazz Dance IV: Intensive	2
DAN237	Ballet Pointe I	1
DAN238	Dance Seminar II	1
DAN241	Dance Notation I	3
DAN264	Choreography I	3
DAN272	Dance Technology	2
HES100	Healthful Living	3
HES126	Women's Health Issues	2
HES154	First Aid/Cardiopulmonary Resuscitation	3
HES201	Substance Abuse and Behavior	3
HES271	Prevention and Treatment of Athletic Injuries	3
PED+++	Physical Activities 101, 102, 201, 202	1
PED115	Lifetime Fitness	2
PED116	Aerobics for Wellness	2
PED120AC	Special Emphasis Activity: Ballet	2
PED150	Introduction to the Tradition and Practice of Yoga I	2
PED155	Introduction to the Tradition and Practice of Yoga II	2
PED177	History of Sports in the United States	3
PED200	Intro to Exercise Science and Physical Education	3
PED210	Movement Analysis	1
PED265	Theory of Coaching	3
PED270	Teaching Yoga: Level I	2
PED271	Teaching Yoga: Level II	2
PED280	Introduction to Yoga Therapy I	2
PED281	Methods of Coaching	3
PED282	Introduction to Yoga Therapy II	2
REC120	Leisure and the Quality of Life	3
REC150AB	Outdoor Adventure Skills	3
REC210	Leisure Delivery Systems	3
WED151	Introduction to Alternative Medicine	3
WED165	Overview of Massage Therapy	2
WED195	Special Topics in Wellness Education	0.5-2
WED218	Aromatherapy	1

HOSPITALITY AND TOURISM/ GOLF MANAGEMENT

HRM

Hospitality, Tourism, and Culinary Arts

Division Office AP 237A (480) 423-6578
Program Director, Larry Williams AP 244 (480) 423-6266

The Hospitality and Tourism/Golf Management program offers students access to a variety of career paths. Program graduates are well prepared for entry-level positions leading to careers as teaching pros, golf directors, club managers, camp directors, pro shop managers, manufacturer sales representatives and other positions in golf, recreation and business. The curriculum provides a firm business core with emphasis in customer service, combined with a focus in physical activities and coaching theory and techniques. Representative job titles include Player/Outside Service Personnel, Golf Shop Associate, and Assistant Golf Professional.

CERTIFICATE OF COMPLETION IN HOSPITALITY AND TOURISM/GOLF MANAGEMENT: 42 credits

ADMISSION CRITERIA:

Written application and oral interview. Contact either the HPERD Division office or the Hospitality, Tourism and Culinary Arts Division office for information.

REQUIRED COURSES: 39 credits

ACC211	Financial Accounting	3
HES154	First Aid/Cardiopulmonary Resuscitation	3
HRM110	Introduction to Hospitality and Tourism Management	3
HRM150	Hospitality and Tourism Information Systems I	3
HRM220	Hospitality Managerial Accounting	3
HRM235	Club Management	3
HRM260	Hospitality Human Resource Management	3
HRM270	Hospitality Marketing	3
PED101KM	Physical Activities: Golf-Advanced (1) AND	
PED102KM	Physical Activities: Golf-Advanced (1) OR	
PED201KM	Physical Activities: Golf-Advanced (1) AND	
PED202KM	Physical Activities: Golf-Advanced (1)	2
PED210JX	Movement Analysis: Golf	1
PED265JX	Theory of Coaching Golf	3
PED281GC	Golf: Methods of Coaching	3
PED/HRM296WC	Cooperative Education	3
REC210	Leisure Delivery Systems	3

RESTRICTED ELECTIVES: 3 credits

HES100	Healthful Living	3
HES271	Prevention and Treatment of Athletic Injuries	3
HRM145	Events Management	3
HRM275	Restaurant Management	3
HRM280	Hospitality and Tourism Law	3
HRM291	Directed Field Study - International	3
PED200	Introduction to Exercise Science and Physical Education	3
PSY215	Introduction to Sport Psychology	3

Grade of "C" or better required for all courses in the Certificate of Completion in Hospitality and Tourism/Golf Management.

Continued next page...

Scottsdale Community College Programs

AAS IN HOSPITALITY AND TOURISM/ GOLF MANAGEMENT: 67-69 credits

ADMISSION CRITERIA:

Written application and oral interview. Contact either the HPERD Division office or the Hospitality, Tourism and Culinary Arts Division office for information.

REQUIRED COURSES: 39 credits

ACC211	Financial Accounting	3
HES154	First Aid/Cardiopulmonary Resuscitation	3
HRM110	Introduction to Hospitality and Tourism Management	3
HRM150	Hospitality and Tourism Information Systems I	3
HRM220	Hospitality Managerial Accounting	3
HRM235	Club Management	3
HRM260	Hospitality Human Resource Management	3
HRM270	Hospitality Marketing	3
PED101KM	Physical Activities: Golf-Advanced (1) AND	
PED102KM	Physical Activities: Golf-Advanced (1) OR	
PED201KM	Physical Activities: Golf-Advanced (1) AND	
PED202KM	Physical Activities: Golf-Advanced (1)	2
PED210JX	Movement Analysis: Golf	1
PED265JX	Theory of Coaching Golf	3
PED281GC	Golf: Methods of Coaching	3
PED/HRM296WC	Cooperative Education	3
REC210	Leisure Delivery Systems	3

RESTRICTED ELECTIVES: 3 credits

HES100	Healthful Living	3
HES271	Prevention and Treatment of Athletic Injuries	3
HRM145	Events Management	3
HRM275	Restaurant Management	3
HRM280	Hospitality and Tourism Law	3
HRM291	Directed Field Study - International	3
PED200	Introduction to Exercise Science and Physical Education	3
PSY215	Introduction to Sport Psychology	3

GENERAL EDUCATION (G.E.) REQUIREMENTS: 25-27 credits

CORE: 15-17 credits

First-Year Composition

ENG101	First-Year Composition (3) OR	
ENG107	First-Year Composition for ESL (3) AND	
ENG102	First-Year Composition (3) OR	
ENG108	First-Year Composition for ESL (3)	6

Oral Communication

COM100	Introduction to Human Communication (3) OR	
COM100AA	Introduction to Human Communication Part I (1) AND	
COM100AB	Introduction to Human Communication Part II (1) AND	
COM100AC	Introduction to Human Communication Part III (1) OR	
COM110	Interpersonal Communication (3) OR	
COM230	Small Group Communication (3)	3

Critical Reading

CRE101	Critical and Evaluative Reading I (3) OR equivalent as indicated by assessment	3
--------	---	---

Mathematics

MAT142	College Mathematics (3) OR	
MAT150/151/152	College Algebra/Functions (3-5)	3-5

DISTRIBUTION: 10 credits

Humanities and Fine Arts

Any approved G. E. course from the Humanities and Fine Arts area		3
--	--	---

Natural Sciences

Any approved G. E. course from the Natural Sciences area		4
--	--	---

Social and Behavioral Sciences

ECN111	Macroeconomic Principles (3) OR	
ECN112	Microeconomic Principles (3) OR	
PSY101	Introduction to Psychology (3) OR	
REC120	Leisure and the Quality of Life (3)	3

Grade of "C" or better required for all courses in the AAS in Hospitality and Tourism/Golf Management.

HOSPITALITY AND TOURISM/ HOTEL MANAGEMENT

HRM

Hospitality, Tourism, and Culinary Arts

Division Office	AP 237A	(480) 423-6578
Program Director, Larry Williams	AP 244	(480) 423-6266

The Hospitality and Tourism/Hotel Management program is designed to train graduates for management careers in the hotel industry, which is among the fastest growing in the United States and offering numerous career opportunities. This program will also transfer to four-year colleges and universities.

CERTIFICATE OF COMPLETION IN HOSPITALITY AND TOURISM/HOTEL MANAGEMENT: 42 credits

REQUIRED COURSES: 36 credits

ACC211	Financial Accounting	3
HRM110	Introduction to Hospitality and Tourism Management	3
HRM120	Hotel Facility Management	3
HRM130	Guest Services Management	3
HRM140	Food Production Concepts	3
HRM150	Hospitality and Tourism Information Systems I	3
HRM220	Hospitality Managerial Accounting	3
HRM250	Hospitality and Tourism Information Systems II	3
HRM260	Hospitality Human Resource Management	3
HRM270	Hospitality Marketing	3
HRM280	Hospitality and Tourism Law	3
HRM296WC	Cooperative Education	3

RESTRICTED ELECTIVES: 6 credits

HRM145	Events Management	3
HRM230	Beverage Management	3
HRM235	Club Management	3
HRM240	Commercial Food Production	3
HRM275	Restaurant Management	3
HRM285	Gaming Management	3
HRM290	Ecotourism	3
HRM291	Directed Field Study - International	3
REC210	Leisure Delivery Systems	3

Grade of "C" or better required for all courses in the Certificate of Completion in Hospitality and Tourism/Hotel Management.

AAS IN HOSPITALITY AND TOURISM/ HOTEL MANAGEMENT: 64-66 credits

REQUIRED COURSES: 33 credits

ACC211	Financial Accounting	3
HRM110	Introduction to Hospitality and Tourism Management	3
HRM120	Hotel Facility Management	3
HRM130	Guest Services Management	3
HRM140	Food Production Concepts	3
HRM150	Hospitality and Tourism Information Systems I	3
HRM220	Hospitality Managerial Accounting	3
HRM250	Hospitality and Tourism Information Systems II	3
HRM260	Hospitality Human Resource Management	3
HRM270	Hospitality Marketing	3
HRM280	Hospitality and Tourism Law	3

RESTRICTED ELECTIVES: 6 credits

HRM145	Events Management	3
HRM230	Beverage Management	3
HRM235	Club Management	3
HRM240	Commercial Food Production	3
HRM275	Restaurant Management	3
HRM285	Gaming Management	3
HRM290	Ecotourism	3
HRM291	Directed Field Study - International	3
HRM296WB-WC	Cooperative Education	2-3
REC210	Leisure Delivery Systems	3

Scottsdale Community College Programs

GENERAL EDUCATION (G.E.) REQUIREMENTS: 25-27 credits

CORE: 15-17 credits

First-Year Composition

ENG101	First-Year Composition (3) OR	
ENG107	First-Year Composition for ESL (3) AND	
ENG102	First-Year Composition (3) OR	
ENG108	First-Year Composition for ESL (3)	6

Oral Communication

Any approved G. E. course from the Oral Communication area 3

Critical Reading

CRE101	Critical and Evaluative Reading I (3) OR Equivalent by assessment.	3
--------	---	---

Mathematics

Any approved G. E. course from the Mathematics area 3-5

DISTRIBUTION: 10 credits

Humanities and Fine Arts

Any approved G. E. course from the Humanities and Fine Arts area 3

Natural Sciences

Any approved G. E. course from the Natural Sciences area 4

Social and Behavioral Sciences

ECN111	Macroeconomic Principles (3) OR	
ECN112	Microeconomic Principles (3) OR	
PSY101	Introduction to Psychology (3) OR	
REC120	Leisure and the Quality of Life (3)	3

Grade of "C" or better required for all courses in the AAS in Hospitality and Tourism/Hotel Management.

HOSPITALITY AND TOURISM/ RESTAURANT MANAGEMENT

HRM

Hospitality, Tourism, and Culinary Arts

Division Office	AP 237A (480) 423-6578
Program Director, Larry Williams	AP 244 (480) 423-6266

The Hospitality and Tourism/Restaurant Management program is designed to train graduates for careers in restaurant and commercial food service management, which is among the largest and fastest growing in the United States and offering numerous career opportunities. This program will also transfer to four-year colleges and universities.

CERTIFICATE OF COMPLETION IN HOSPITALITY AND TOURISM/RESTAURANT MANAGEMENT: 42 credits

REQUIRED COURSES: 36 credits

ACC211	Financial Accounting	3
HRM110	Introduction to Hospitality and Tourism Management	3
HRM140	Food Production Concepts	3
HRM150	Hospitality and Tourism Information Systems I	3
HRM220	Hospitality Managerial Accounting	3
HRM230	Beverage Management	3
HRM250	Hospitality and Tourism Information Systems II	3
HRM260	Hospitality Human Resource Management	3
HRM270	Hospitality Marketing	3
HRM275	Restaurant Management	3
HRM280	Hospitality and Tourism Law	3
HRM296WC	Cooperative Education	3

RESTRICTED ELECTIVES: 6 credits

CUL180	Food in History	3
CUL190	Catering Operations I	3
HRM145	Events Management	3
HRM235	Club Management	3
HRM240	Commercial Food Production	3
HRM285	Gaming Management	3
HRM291	Directed Field Study - International	3

Grade of "C" or better required for all courses in the Certificate of Completion in Hospitality and Tourism/Restaurant Management.

AAS IN HOSPITALITY AND TOURISM/ RESTAURANT MANAGEMENT: 64-66 credits

REQUIRED COURSES: 33 credits

ACC211	Financial Accounting	3
HRM110	Introduction to Hospitality and Tourism Management	3
HRM140	Food Production Concepts	3
HRM150	Hospitality and Tourism Information Systems I	3
HRM220	Hospitality Managerial Accounting	3
HRM230	Beverage Management	3
HRM250	Hospitality and Tourism Information Systems II	3
HRM260	Hospitality Human Resource Management	3
HRM270	Hospitality Marketing	3
HRM275	Restaurant Management	3
HRM280	Hospitality and Tourism Law	3

RESTRICTED ELECTIVES: 6 credits

CUL180	Food in History	3
CUL190	Catering Operations I	3
HRM145	Events Management	3
HRM235	Club Management	3
HRM240	Commercial Food Production	3
HRM285	Gaming Management	3
HRM291	Directed Field Study - International	3
HRM296WB-WC	Cooperative Education	2-3

GENERAL EDUCATION (G.E.) REQUIREMENTS: 25-27 credits

CORE: 15-17 credits

First-Year Composition

ENG101	First-Year Composition (3) OR	
ENG107	First-Year Composition for ESL (3) AND	
ENG102	First-Year Composition (3) OR	
ENG108	First-Year Composition for ESL (3)	6

Oral Communication

Any approved G. E. course from the Oral Communication area 3

Critical Reading

CRE101	Critical and Evaluative Reading I (3) OR Equivalent by assessment.	3
--------	---	---

Mathematics

Any approved G. E. course from the Mathematics area 3-5

DISTRIBUTION: 10 credits

Humanities and Fine Arts

Any approved G. E. course from the Humanities and Fine Arts area 3

Natural Sciences

Any approved G. E. course from the Natural Sciences area 4

Social and Behavioral Sciences

ECN111	Macroeconomic Principles (3) OR	
ECN112	Microeconomic Principles (3) OR	
PSY101	Introduction to Psychology (3) OR	
REC120	Leisure and the Quality of Life (3)	3

Grade of "C" or better required for all courses in the AAS in Hospitality and Tourism/Restaurant Management.

Scottsdale Community College Programs

INFANT/TODDLER DEVELOPMENT CFS, ECH, EED, ITD

Social/Behavioral Sciences Division Office..... SB 130 (480) 423-6206
 Program Director, Dr. Rosanne Dlugosz..... SB 126 (480) 423-6204

The Infant/Toddler Development program is designed to prepare individuals to enter the workforce as Early Childhood Professionals and to assist individuals employed in the field to upgrade and expand their skills. The program focuses on the unique developmental needs of contemporary infants and toddlers within the contexts of family, community, early care, and education.

Most coursework in the Infant/Toddler Certificate may also be applied to the AAS in Early Childhood Development (see page 89). Selected courses in this program are available in the day session, but most will be offered in the evening or on Saturdays. Courses in the ITD program will be offered in rotation over several semesters.

Individuals employed or assisting in state licensed early childhood facilities will be required to meet regulatory standards in effect at the time of employment. This may typically include fingerprint check, TB tests, immunizations, CPR/first aid training, and food handler training.

CERTIFICATE OF COMPLETION IN INFANT/TODDLER DEVELOPMENT: 30 credits

REQUIRED COURSES: 27 credits

CFS181	Enhancing Infant and Toddler Development	3
CFS220	Introduction to Parenting and Family Development	3
ECH128	Early Learning: Play and the Arts	3
ECH176	Child Development (3) OR	
EED276	Global Child Development (3) OR	
PSY240	Developmental Psychology (3)	3
EED200	Foundations of Early Childhood Education	3
EED212	Guidance, Management and the Environment.....	3
EED215	Early Learning: Health, Safety, Nutrition and Fitness	3
EED222	Introduction to the Exceptional Young Child	3
ITD205	Emerging Individuality	1
EED260	Early Childhood Infant/Toddler Internship (1) AND	
EED260	Early Childhood Infant/Toddler Internship (1) OR	
ECH296WB	Cooperative Education (2)	2

RESTRICTED ELECTIVES: 3 credits

CFS/ECH120	Contemporary Issues in Early Childhood Education	1
CFS190	Home Based Visitation	3
ECH126AB	Play Lab-Toddlers	1
ECH/ITD183	Infant/Toddler Learning Materials	1
ECH237	Media for Young Children	1
ECH276	Musical Beginnings	1
ITD260	Reflective Case Study	1

Grade of "C" or better required for all courses in the Certificate of Completion in Infant/Toddler Development.

INTERIOR DESIGN

INT

Applied Sciences Division Office..... AP 237B (480) 423-6599
 Program Director, Gera King..... AP 235 (480) 423-6442

The mission of the Interior Design Program is to provide a comprehensive educational experience with pathways leading to professional placement in the interiors industry. The two-tiered curriculum consists of an Associate in Applied Science (AAS) in Interior Design that provides foundational knowledge and skills and a Certificate of Completion (CCL) in Interior Design: Professional Level that offers specialized knowledge within the interiors industry. The two-tiered program is nationally accredited by the Council for Interior Design Accreditation (CIDA), formerly known as FIDER.

AAS IN INTERIOR DESIGN: 64-66 credits

REQUIRED COURSES: 42 credits

ARC121	Introduction to Architectural Drafting: Manual	3
ARC141	Architectural CAD I: Introduction	3
ARC142	Architectural CAD II: Plans and Elevations	3
INT105	Introduction to Interior Design	3
INT115	Historical Architecture and Furniture	3
INT120	Modern Architecture and Furniture	3
INT145	Drawing and Rendering	3
INT150	Color and Design	3
INT160	Fabrics for Interiors	3
INT170	Interior Materials	3
INT190	Space Planning	3
INT225	History of Decorative Arts	3
INT230	Presentation Techniques	3
INT240	Kitchen and Bath Design	3

GENERAL EDUCATION (G.E.) REQUIREMENTS: 22-24 credits

CORE: 15-17 credits

First-Year Composition

Any approved G. E. courses in the First-Year Composition area 6

Oral Communication

Any approved G. E. course from the Oral Communication area 3

Critical Reading

CRE101 Critical and Evaluative Reading I (3) OR
 equivalent as indicated by assessment 3

Mathematics

Any approved G. E. course from the Mathematics area 3-5

DISTRIBUTION: 7 credits

Humanities and Fine Arts

Met by INT115 and INT120 in Required Courses area 0

Natural Sciences

Any approved G. E. course from the Natural Sciences area 4

Social and Behavioral Sciences

Any approved G. E. course from the Social/Behavioral Sciences area 3

Grade of "C" or better required for all courses within the AAS in Interior Design.

Continued next page...

Scottsdale Community College Programs

CERTIFICATE OF COMPLETION IN INTERIOR DESIGN: PROFESSIONAL LEVEL: 27 credits

The Professional Level Certificate of Completion (CCL) in Interior Design provides coursework in interior codes, including the Americans with Disabilities Act (ADA), lighting, building systems, commercial design and professional practices. An internship provides students opportunities to develop job skills in the field.

ADMISSION CRITERIA: Application and Portfolio Review.

PROGRAM PREREQUISITES: An AAS in Interior Design or equivalent and permission of the Program Director.

REQUIRED COURSES: 18 credits

INT215	Professional Practices	3
INT260	Interior Codes and Regulations	3
INT265	Building Systems	3
INT268	Lighting Design	3
INT270	Commercial Design	3
INT271++	Interior Design Internship (any suffixed courses)	3

RESTRICTED ELECTIVES: 9 credits

ARH+++++	Any Art Humanities courses	6
ASB+++++	Any Anthropology course (3) OR	
PSY+++++	Any Psychology course (3) OR	
SOC+++++	Any Sociology course (3)	3

Grade of "C" or better required for all courses within the CCL in Interior Design: Professional Level.

JOURNALISM JRN

Language/Communication Division Office.. LC 305 (480) 423-6459
Program Contact, Dr. Christine Ferguson ..LC 350 (480) 423-6417

The Certificate of Completion in Journalism prepares students to work in the publishing industry whether they have a bachelor's degree in another discipline or are just beginning their career path in journalism. The CCL includes journalism courses required by journalism schools throughout the state and country and requires an internship in journalism and a juried portfolio of published articles to complete the certificate.

CERTIFICATE OF COMPLETION IN JOURNALISM: 18 credits

REQUIRED COURSES: 15 credits

ENG101	First-Year Composition	3
ENG235	Magazine Article Writing (3) OR	
JRN234	Feature Writing (3)	3
JRN201	News Writing	3
JRN240AB	Journalism Internship	2
JRN298AA	Special Projects: Portfolio of Published Clips	1
MCO120	Media and Society	3

RESTRICTED ELECTIVES: 3 credits

JRN125	Photo Editing	3
JRN133	Development of Small Publications	3
JRN212	Broadcast Writing	3
JRN215	News Production	3

Grade of "C" or better required for all courses in the Certificate of Completion in Journalism.

MANAGEMENT

MGT

Business Division Office AP 237A (480) 423-6253

CERTIFICATE OF COMPLETION IN MANAGEMENT: 30 credits

Students can earn a Certificate of Completion in Management. Please see page 79 for detailed information on the required coursework.

AAS IN BUSINESS: 64-66 credits

Students can earn an AAS degree in Business with a specialization in Management. Please see page 78, "Business" for detailed information on the required coursework.

MARKETING

MKT

Business Division Office AP 237A (480) 423-6253

CERTIFICATE OF COMPLETION IN MARKETING: 39 credits

Students can earn a Certificate of Completion in Marketing. Please see page 79 for detailed information on the required coursework.

AAS IN BUSINESS: 64-66 credits

Students can earn an AAS degree in Business with a specialization in Marketing. Please see 78, "Business" for detailed information on the required coursework.

Scottsdale Community College Programs

MICROSOFT NETWORKING TECHNOLOGY

MST

Business Division Office AP 237A (480) 423-6253
 Program Director, Jim Simpson CM 408 (480) 423-6257

The Associate in Applied Science in Microsoft Networking Technology provides training for a supervisory-level position working with Windows networks. The program develops skills to implement a network infrastructure and install, configure, monitor, optimize, and troubleshoot Windows server and Windows client workstations. Courses in the program also help to prepare for Microsoft Certified Product Specialist (MCP), Microsoft Certified Systems Administrator (MCSA), and Microsoft Certified Systems Engineer (MCSE) examinations. The curriculum is taught by Microsoft Certified Professionals.

ALSO SEE: Computer Hardware and Network Support, page 80
 Computer Information Systems, page 81
 Microsoft Applications Development, page 104
 Network Administration, page 82
 Office Automation Systems, page 112
 Personal Computer Applications, page 80
 Programming and System Analysis, page 83
 Web Design, page 84
 Web Development, page 85

PROGRAM NOTES: Overall program minimum GPA = 2.00.

CERTIFICATE OF COMPLETION IN MICROSOFT DESKTOP SUPPORT TECHNOLOGY: 18-19 credits

The Certificate of Completion in Microsoft Desktop Support Technology is designed to provide training to work in an entry-level computer maintenance and help-desk position. Students will develop the skills to successfully troubleshoot desktop environments running on the Microsoft Windows operating system. Courses in the program also help to prepare for the Microsoft Certified Desktop Support Technician (MCDST) examinations.

PROGRAM PREREQUISITES: 2 credits

In lieu of the courses listed below, students with experience in the information technology field may meet these program prerequisite requirements with the permission of the instructor.

BPC/CIS121AB Microsoft Command Line Operations 1
 CIS102 Interpersonal/Customer Service Skills for IT Professionals 1

REQUIRED COURSES: 18-19 credits

BPC110 Computer Usage and Applications (3) OR
 CIS105 Survey of Computer Information Systems (3) 3
 BPC170 Computer Maintenance I: A+ Prep 3
 CIS190 Introduction to Local Area Networks (3) OR
 CNT140 Cisco Networking Basics (4) OR
 MST140 Microsoft Networking Essentials (3) 3-4
 MST141 Supporting MS Windows Desktop Operating Systems 3
 MST142 Supporting Applications on MS Windows Desktop Oper. Sys. ... 3
 MST150XP Microsoft Windows XP Professional 3

Grade of "C" or better required for all courses in the Certificate of Completion in Microsoft Desktop Support Technology.

CERTIFICATE OF COMPLETION IN MICROSOFT PRODUCT SPECIALIST: 14-15 credits

PROGRAM PREREQUISITES: 3 credits

CIS105 Survey of Computer Information Systems (3) OR
 permission of Department or Division 3

REQUIRED COURSES: 14-15 credits

BPC/CIS121AB Microsoft Command Line Operations 1
 BPC170 Computer Maintenance I: A+ Prep 3
 CIS190 Introduction to Local Area Networks (3) OR
 CNT140 Cisco Networking Fundamentals (4) OR
 MST140 Microsoft Networking Essentials (3) 3-4
 MST150++ Any MST150 course 3
 MST152++ Any MST152 course 4

Grade of "C" or better required for all courses in the Certificate of Completion in Microsoft Product Specialist.

CERTIFICATE OF COMPLETION IN MICROSOFT SYSTEMS ADMINISTRATION: 20-21 credits

PROGRAM PREREQUISITES: 3 credits

CIS105 Survey of Computer Information Systems (3) OR
 permission of Department or Division 3

REQUIRED COURSES: 20-21 credits

BPC/CIS121AB Microsoft Command Line Operations 1
 BPC170 Computer Maintenance I: A+ Prep 3
 CIS190 Introduction to Local Area Networks (3) OR
 CNT140 Cisco Networking Basics (4) OR
 MST140 Microsoft Networking Essentials (3) 3-4
 MST150++ Any MST150 course 3
 MST152++ Any MST152 course 4
 MST155 Implementing Windows Network Infrastructure 3
 MST232 Managing a Windows Network Environment 3

Grade of "C" or better required for all courses in the Certificate of Completion in Microsoft Systems Administration.

CERTIFICATE OF COMPLETION IN MICROSOFT SYSTEMS ENGINEER: 32-33 credits

PROGRAM PREREQUISITES: 3 credits

CIS105 Survey of Computer Information Systems (3) OR
 permission of Department or Division 3

REQUIRED COURSES: 32-33 credits

BPC/CIS121AB Microsoft Command Line Operations 1
 BPC170 Computer Maintenance I: A+ Prep 3
 CIS190 Introduction to Local Area Networks (3) OR
 CNT140 Cisco Networking Basics (4) OR
 MST140 Microsoft Networking Essentials (3) 3-4
 MST150++ Any MST150 course 3
 MST152++ Any MST152 course 4
 MST155 Implementing Windows Network Infrastructure 3
 MST157 Implementing Windows Directory Services 3
 MST232 Managing a Windows Network Environment 3
 MST244 Microsoft SQL Server Administration 3
 MST253 Designing MS Windows 2000 Directory Svcs Infrastructure (3) OR
 MST259 Designing Windows Network Security (3) 3
 MST255 Designing Windows Network Infrastructure 3

Grade of "C" or better required for all courses in the Certificate of Completion in Microsoft Systems Engineer.

Scottsdale Community College Programs

AAS IN MICROSOFT NETWORKING TECHNOLOGY: 62-63 credits

PROGRAM PREREQUISITES: 3 credits

CIS105	Survey of Computer Information Systems (3) OR permission of Department or Division	3
--------	---	---

REQUIRED COURSES: 24-25 credits

BPC/CIS121AB	MS-DOS Operating System	1
BPC170	Computer Maintenance I: A+ Prep	3
CIS102	Interpersonal/Customer Service Skills for IT Professionals	1
CIS126DA	UNIX Operating System (3) OR	
CIS126AA	UNIX Operating System: Level I (1) AND	
CIS126BA	UNIX Operating System: Level II (1) AND	
CIS126CA	UNIX Operating System: Level III (1)	3
CIS126DL	Linux Operating System (3) OR	
CIS126AL	Linux Operating System: Level I (1) AND	
CIS126BL	Linux Operating System: Level II (1) AND	
CIS126CL	Linux Operating System: Level III (1)	3
CIS190	Introduction to Local Area Networks (3) OR	
CNT140	Cisco Networking Basics (4) OR	
MST140	Microsoft Networking Essentials (3)	3-4
MST150++	Microsoft Windows Professional (any course)	3
MST152++	Microsoft Windows Server (any course)	4
MST155	Implementing Windows Network Infrastructure	3
MST157	Implementing Windows Directory Services	3

RESTRICTED ELECTIVES: 13 credits

For MST150++ and MST152++, select a different MS Windows version than the one selected for Required Courses. Students should select thirteen (13) credits from the following courses in consultation with a program advisor:

BPC110	Computer Usage and Applications (3) OR	
CIS105	Survey of Computer Information Systems (3)	3
BPC171	Recycling Used Computer Technology	1-3
BPC270	Microcomputer Maintenance II	3
CIS150	Programming Fundamentals	3
CIS159	Visual Basic Programming I	3
CIS162AB	C++: Level I (3) OR	
CIS162AC	Visual C++: Level I (3)	3
CIS280++	Any CIS280 Current Topics in Computing course	1-3

Students may select no more than four (4) credits combined from CIS282AA-AC, CIS290AA-AC and CIS296WA-WD courses.

CIS282++	Volunteerism for Computer Information Systems: A Service Learning Experience (any module) (1-3) OR	
CIS290++	CIS Internship (any module) (1-3) OR	
CIS296++	Cooperative Education (any module) (1-4)	1-4
CNT150	Cisco Networking Router Technologies	4
MST141	Supporting MS Windows Desktop Operating Systems	3
MST142	Supporting Applications on MS Windows Desktop Oper. Sys.	3
MST150++	Microsoft Windows Professional (any course)	3
MST152++	Microsoft Windows Server (any course)	4
MST232	Managing a Windows Network Environment	3
MST242	Microsoft Exchange Server	4
MST244	Microsoft SQL Server Administration	3
MST252	Microsoft Windows Network Upgrade	3
MST253	Designing MS Windows 2000 Directory Services Infrastructure	3
MST254	Microsoft SQL Server Design and Implementation	3
MST255	Designing Windows Network Infrastructure	3
MST259	Designing Windows Network Security	3

GENERAL EDUCATION (G.E.) REQUIREMENTS: 25 credits

CORE: 15 credits

First-Year Composition

ENG101	First-Year Composition (3) AND	
ENG102	First-Year Composition (3) OR	
ENG107	First-Year Composition for ESL (3) AND	
ENG108	First-Year Composition for ESL (3)	6

Oral Communication

Any approved G. E. course from the Oral Communication area		3
--	--	---

Critical Reading

CRE101	Critical and Evaluative Reading I (3) OR	
Equivalent as indicated by assessment		3

Mathematics

Any approved G. E. course from the Mathematics area		3
---	--	---

DISTRIBUTION: 10 credits

Humanities and Fine Arts

Any approved G. E. course from the Humanities and Fine Arts area		3
--	--	---

Social and Behavioral Sciences

Any approved G. E. course from the Social/Behavioral Sciences area		3
--	--	---

Natural Sciences

Any approved G. E. course from the Natural Sciences area		4
--	--	---

Grade of "C" or better required for all courses in the AAS in Microsoft Networking Technology.

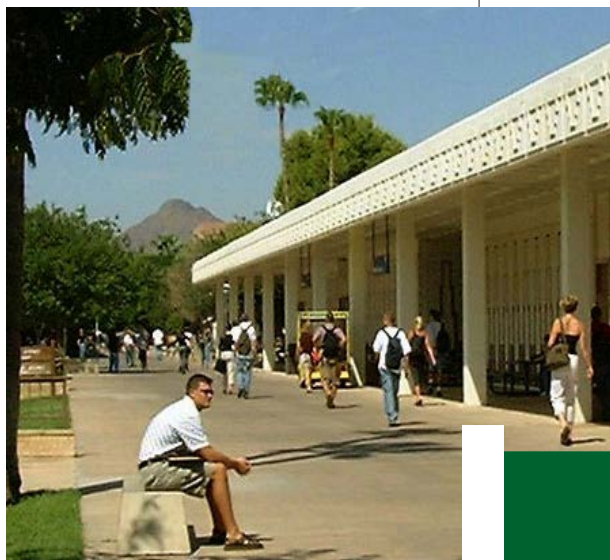

**Life/Physical
Science Building**

Scottsdale Community College Programs

MICROSOFT APPLICATIONS DEVELOPMENT MST

Business Division Office AP 237A (480) 423-6253
 Program Director, Jim Simpson CM 408 (480) 423-6257

The Certificate of Completion in Microsoft Applications Development and the Associate in Applied Science in Microsoft Applications Development are designed to provide training for developers who develop, deploy, and maintain applications and components using Visual Studio: Visual Basic (VB), C++, and Structured Query Language (SQL). They also provide training for the Microsoft Certified Application Developer (MCAD) certification examinations. The MCAD credential is appropriate for professionals who use Microsoft technologies to develop and maintain department-level applications, components, Web or desktop clients, or back-end data services or work in teams developing enterprise applications. NOTE: This program was formerly known as Microsoft Solutions Development.

ALSO SEE: Computer Hardware and Network Support, page 80
 Computer Information Systems, page 81
 Microsoft Networking Technology, page 103
 Network Administration, page 82
 Office Automation Systems, page 112
 Personal Computer Applications, page 80
 Programming and System Analysis, page 83
 Web Design, page 84
 Web Development, page 85

PROGRAM NOTES:

Students entering the Microsoft Applications Development program often come with background or experience in the computer programming area. Students must consult with a program advisor as the program prerequisites may not be necessary and may be waived as requirements to the program.

CERTIFICATE OF COMPLETION IN MICROSOFT APPLICATIONS DEVELOPMENT: 22 credits

PROGRAM PREREQUISITES: 6 credits

CIS105 Survey of Computer Information Systems 3
 CRE101 Critical and Evaluative Reading I (3) OR
 equivalent as indicated by assessment OR
 permission of Department or Division 3

REQUIRED COURSES: 22 credits

BPC/CIS133DA Internet/Web Development Level I (3) OR
 BPC/CIS133AA Internet/Web Development Level I-A (1) AND
 BPC/CIS133BA Internet/Web Development Level I-B (1) AND
 BPC/CIS133CA Internet/Web Development Level I-C (1) 3
 CIS102 Interpersonal/Customer Service Skills for IT Professionals 1
 CIS159 Visual Basic Programming I 3
 CIS259 Visual Basic Programming II 3
 CIS164AG Oracle: Data Modeling/Relational Database Design (2) OR
 MST146 Data Modeling and Relational Database Design (2) 2
 MST172 Visual Basic .NET Web Application Development 4
 MST176 Visual Basic .NET XML Web Services Development 3
 MST254 Microsoft SQL Server Design and Implementation 3

Grade of "C" or better required for all courses in the Certificate of Completion in Microsoft Applications Development.

AAS IN MICROSOFT APPLICATIONS DEVELOPMENT: 60-62 credits

PROGRAM PREREQUISITES: 6 credits

CIS105 Survey of Computer Information Systems 3
 CRE101 Critical and Evaluative Reading I (3) OR
 equivalent as indicated by assessment OR
 permission of Department or Division 3

REQUIRED COURSES: 22 credits

BPC/CIS133DA Internet/Web Development Level I (3) OR
 BPC/CIS133AA Internet/Web Development Level I-A (1) AND
 BPC/CIS133BA Internet/Web Development Level I-B (1) AND
 BPC/CIS133CA Internet/Web Development Level I-C (1) 3
 CIS102 Interpersonal/Customer Service Skills for IT Professionals 1
 CIS159 Visual Basic Programming I 3
 CIS259 Visual Basic Programming II 3
 CIS164AG Oracle: Data Modeling/Relational Database Design (2) OR
 MST146 Data Modeling and Relational Database Design (2) 2
 MST172 Visual Basic .NET Web Application Development 4
 MST176 Visual Basic .NET XML Web Services Development 3
 MST254 Microsoft SQL Server Design and Implementation 3

RESTRICTED ELECTIVES: 16 credits

CIS119DO Introduction to Oracle: SQL 3
 CIS150 Programming Fundamentals 3
 CIS162++ Any CIS162 course 3
 CIS163AA Java Programming: Level I 3
 CIS190 Introduction to Local Area Networks (3) OR
 CNT140 Cisco Networking Basics (4) OR
 MST140 Microsoft Networking Essentials (3) 3-4
 CIS225AB Object-Oriented Analysis and Design 3
 CIS235 e-Commerce 3

Course Note:

Students may select no more than four (4) credits combined from

CIS290AA-AC and CIS296WA-WD courses.
 CIS290A+ CIS Internship (any module) (1-3) OR
 CIS296W+ Cooperative Education (any module) (1-4) 1-4
 MST150++ Any MST150 course 3
 MST152++ Any MST152 course 3-4
 MST244 Microsoft SQL Server Administration 3
 MST298A+ Special Projects (any module) 1-3

GENERAL EDUCATION (G.E.) REQUIREMENTS: 22-24 credits

CORE: 12-14 credits

First-Year Composition

ENG101 First-Year Composition (3) AND
 ENG102 First-Year Composition (3) OR
 ENG107 First-Year Composition for ESL (3) AND
 ENG108 First-Year Composition for ESL (3) 6

Oral Communication

Any approved G. E. course from the Oral Communication area 3

Critical Reading

Met by CRE101 in the Program Prerequisites area 0

Mathematics

MAT120 Intermediate Algebra (5) OR
 MAT121 Intermediate Algebra (4) OR
 MAT122 Intermediate Algebra (3) OR
 Equivalent OR satisfactory
 completion of a higher-level mathematics course 3-5

DISTRIBUTION: 10 credits

Humanities and Fine Arts

Any approved G. E. course from the Humanities and Fine Arts area 3

Social and Behavioral Sciences

Any approved G. E. course from the Social/Behavioral Sciences area 3

Natural Sciences

Any approved G. E. course from the Natural Sciences area 4

Grade of "C" or better required for all courses in the AAS in Microsoft Applications Development.

Scottsdale Community College Programs

MOTION PICTURE/TELEVISION PRODUCTION

TCM

Fine Arts Division Office MB 139 (480) 423-6328
 Department Chairperson, Kate Herbert LC 332 (480) 423-6657

The Motion Picture/Television Production Program is designed for students who plan to enter the field of motion pictures and/or television production. Successful completion of this program will qualify students for the AAS degree in Motion Picture/Television Production. Students will receive hands-on practical training in a fine arts learning environment and may select one or more of several specialization tracks within the AAS degree.

Certificates of Completion in Screenwriting, Broadcast Production, Film Production, Editing, and Film Analysis and Criticism are also available.

REQUIREMENTS FOR THE AAS DEGREE AND CERTIFICATES OF COMPLETION

Program Prerequisites: 3 Credits

TCM100 Digital Multimedia (3) OR
 waived by permission of Program Director 3

Program Common Core: 15 Credits

The Common Core courses listed below are required for all of the certificate programs and the AAS degree.

REQUIRED COURSES: 15 credits

HUM/THE205 Introduction to Cinema 3
 TCM101 Fundamentals of Radio and Television 3
 TCM134 Pre-Production for Motion Picture and Television 3
 TCM135 Production for Motion Picture and Television 3
 TCM136 Post-Production for Motion Picture and Television 3

Program Tracks

In addition to the courses required in the Program Prerequisites and Common Core areas listed above, the required courses in a specialization area (listed below), and the minimum Restricted Elective credits must be completed to earn a certificate in a selected Program Track (see the required courses on the page listed):page#

Track I: Certificate of Completion in Screenwriting 106
 Track II: Certificate of Completion in Broadcast Production 106
 Track III: Certificate of Completion in Film Production 107
 Track IV: Certificate of Completion in Editing 107
 Track V: Certificate of Completion in Film Analysis and Criticism 107

AAS IN MOTION PICTURE/TELEVISION PRODUCTION: 67-70 credits

The general studies requirement of 22-24 credits must be completed in addition to the credits earned in the Program Common Core, a Program Track and the Restricted Electives to earn the total of 67-70 credits required for the AAS in Motion Picture/Television Production.

PROGRAM PREREQUISITES: 3 credits

TCM100 Digital Multimedia (3) OR
 waived by permission of Program Director 3

GENERAL EDUCATION (G.E.) REQUIREMENTS: 22-24 credits

CORE: 15-17 credits

First-Year Composition

ENG101 First-Year Composition (3) OR
 ENG107 First-Year Composition for ESL (3) 3
 ENG102 First-Year Composition (3) OR
 ENG108 First-Year Composition for ESL (3) 3

Oral Communication

Any approved G. E. course from the Oral Communication area 3

Critical Reading

CRE101 Critical and Evaluative Reading I (3) OR
 equivalent as indicated by assessment 3

Mathematics

Any approved G. E. course from the Mathematics area 3-5

DISTRIBUTION: 7 credits

Humanities and Fine Arts

Met by HUM/THE205 course listed in the Required Courses areas 0

Natural Sciences

Any approved G. E. course from the Natural Sciences area 4

Social and Behavioral Sciences

Any approved G. E. course from the Social/Behavioral Sciences area 3

Grade of "C" or better required for all courses in the AAS in Motion Picture/Television Production.

Continued next page...



**News in five ...
four...three**

Scottsdale Community College Programs

CERTIFICATE OF COMPLETION IN SCREENWRITING: 45 credits

The Certificate of Completion in Screenwriting is designed for students who plan to enter the field of Motion Picture/Television Production as screenwriters. Students will receive hands-on training in Motion Picture/Television Production, in feature film and media theory. Students will also write a variety of screenplays for short films, feature films and television markets.

PROGRAM PREREQUISITES: 9 credits

ENG101	First-Year Composition (3) OR	
ENG107	First-Year Composition for ESL (3)	3
ENG102	First-Year Composition (3) OR	
ENG108	First-Year Composition for ESL (3)	3
TCM100	Digital Multimedia (3) OR	
	waived by permission of Program Director	3

REQUIRED COURSES: 33 credits

HUM/THE205	Introduction to Cinema	3
TCM101	Fundamentals of Radio and Television	3
TCM111	Screenwriting I	3
TCM111AA	Screenwriting I: The Short Film	3
TCM112	Writing the Situation Comedy (3) OR	
TCM116	Writing the Television Drama (3)	3
TCM134	Pre-Production for Motion Picture and Television	3
TCM135	Production for Motion Picture and Television	3
TCM136	Post-Production for Motion Picture and Television	3
TCM211	Screenwriting II	3
TCM216	Screenwriting III	3
TCM218	Screenwriting IV	3

RESTRICTED ELECTIVES: 12 credits

ENG210	Creative Writing	3
HUM/THE210	Contemporary Cinema	3
HUM211AA	Foreign Films: Classics	3
TCM140	Modern Media Concepts	3
TCM213	Motion Picture Workshop	4
TCM214	Television Workshop	3
TCM250	Documentaries for Social Change	4
TCM285++	Special Topics: Motion Picture/TV Production (any module)..	1-3
TCM296++	Cooperative Education (any suffixed course)	1-4

Grade of "C" or better required for all courses in the Certificate of Completion in Screenwriting.

CERTIFICATE OF COMPLETION IN BROADCAST PRODUCTION: 45 credits

The Certificate of Completion in Broadcast Production is designed for students who plan to enter the field of Motion Picture/Television Production in the specific area of broadcasting. Students will receive hands-on training in Motion Picture/Television Production, in media theory and in the production of both live and pre-recorded television shows including news, sports, commercials, on-the-scene reporting, interviewing and studio anchoring. Technical elements stressed include multi-camera techniques in studio, on-location shooting, editing, sound, graphics, and the operation of the studio.

PROGRAM PREREQUISITES: 3 credits

TCM100	Digital Multimedia (3) OR	
	waived by permission of Program Director	3

REQUIRED COURSES: 37 credits

HUM/THE205	Introduction to Cinema	3
TCM101	Fundamentals of Radio and Television	3
TCM134	Pre-Production for Motion Picture and Television	3
TCM135	Production for Motion Picture and Television	3
TCM136	Post-Production for Motion Picture and Television	3
TCM151	Broadcast Production	2
TCM180	Television Production Techniques	4
TCM240	Advanced Television Production	3
TCM241AA	Introduction to Non-Linear Editing: AVID (4) OR	
TCM241AB	Introduction to Non-Linear Editing: Final Cut Pro (4)	4
TCM242	Portfolio Non-Linear Editing	2
TCM250	Documentaries for Social Change	4
TCM251	Advanced Studio Production	3

RESTRICTED ELECTIVES: 8 credits

ADA/ART177	Computer-Photographic Imaging	3
ART100	Introduction to Computer Graphic Art	1
ART131	Photography I	3
TCM111	Screenwriting I	3
TCM/MTC120	Introduction to Sound Design for Film and Video	3
TCM131	Radio-Television Announcing	4
TCM214	Television Workshop	3
TCM215	Cinematography	3
TCM219	Introduction to Television Technology	3
TCM260	Film/Video Producing and Financing	3
TCM285++	Special Topics: Motion Picture/TV Production (any module)..	1-3
TCM296++	Cooperative Education (any suffixed course)	1-4

Grade of "C" or better required for all courses in the Certificate of Completion in Broadcast Production.

Scottsdale Community College Programs

CERTIFICATE OF COMPLETION IN FILM PRODUCTION: 46 credits

The Certificate of Completion in Film Production is designed for students who plan to enter the production aspect of motion pictures. Students will receive hands-on training in Motion Picture/Television Production by producing a variety of short films and videos which will include writing screenplays, developing a production, demonstrating cinematographic principles, organizing production crews, participating as a production crew member, recording and designing sound, and editing the finished product. In addition, students will study feature film theory.

PROGRAM PREREQUISITES: 3 credits

TCM100 Digital Multimedia (3) OR
waived by permission of Program Director 3

REQUIRED COURSES: 43 credits

HUM/THE205 Introduction to Cinema 3
TCM101 Fundamentals of Radio and Television 3
TCM111 Screenwriting I 3
TCM/MTC120 Introduction to Sound Design for Film and Video 3
TCM134 Pre-Production for Motion Picture and Television 3
TCM135 Production for Motion Picture and Television 3
TCM136 Post-Production for Motion Picture and Television 3
TCM151 Broadcast Production 2
TCM215 Cinematography 3
TCM230 Motion Picture Directing 4
TCM241AA Introduction to Non-Linear Editing: AVID 4
TCM242 Portfolio Non-Linear Editing 2
TCM245 Advanced Motion Picture Production 4
TCM260 Film/Video Producing and Financing 3

RESTRICTED ELECTIVES: 3 credits

ART131 Photography I 3
TCM213 Motion Picture Workshop 4
TCM213AA Motion Picture Workshop: On-Location Shooting 4
TCM/MTC220 Advanced Sound Design for Film and Video 3
TCM240 Advanced Television Production 3
TCM250 Documentaries for Social Change 4
TCM285++ Special Topics: Motion Picture/TV Production (any module).. 1-3
TCM296++ Cooperative Education (any suffixed course) 1-4
THP112 Acting I 3
THP210 Acting: Television and Film 3

Grade of "C" or better required for all courses in the Certificate of Completion in Film Production.

CERTIFICATE OF COMPLETION IN EDITING: 45 credits

The Certificate of Completion in Editing is designed for students who plan to enter the field of Motion Picture/Television Production as editors. Students will receive hands-on training in Motion Picture/Television Production, media theory and editing theory. Students will demonstrate their knowledge by producing a variety of projects using both linear and non-linear systems and by using computer-based video compositing and title animation.

PROGRAM NOTE: *Indicates course will not apply in both Required Courses and Restricted Electives area.

PROGRAM PREREQUISITES: 3 credits

TCM100 Digital Multimedia (3) OR
waived by permission of Program Director 3

REQUIRED COURSES: 42 credits

ADA/ART177 Computer-Photographic Imaging 3
HUM/THE205 Introduction to Cinema 3
TCM101 Fundamentals of Radio and Television 3
TCM/MTC120 Introduction to Sound Design for Film and Video 3
TCM134 Pre-Production for Motion Picture and Television 3
TCM135 Production for Motion Picture and Television 3
TCM136 Post-Production for Motion Picture and Television 3
TCM241AA Introduction to Non-Linear Editing: AVID 4
TCM241AB Introduction to Non-Linear Editing: Final Cut Pro 4

TCM242 Portfolio Non-Linear Editing 2
TCM243 Introduction to Video Compositing and Title Animation 4
TCM271* Advanced Non-Linear Effects and Compositing (4) OR
TCM282AA* Advanced Non-Linear Editing Techniques: AVID (4) 4
TCM280 The Art of Editing 3

RESTRICTED ELECTIVES: 3 credits

ART100 Introduction to Computer Graphic Art 1
ART131 Photography I 3
TCM151 Broadcast Production 2
TCM180 Television Production Techniques 4
TCM215 Cinematography 3
TCM219 Introduction to Television Technology 3
TCM/MTC220 Advanced Sound Design for Film and Video 3
TCM240 Advanced Television Production 3
TCM250 Documentaries for Social Change 4
TCM260 Film/Video Producing and Financing 3
TCM271* Advanced Non-Linear Effects and Compositing (4) OR
TCM282AA* Advanced Non-Linear Editing Techniques: AVID (4) 4
TCM285++ Special Topics: Motion Picture/TV Production (any module).. 1-3
TCM296++ Cooperative Education (any suffixed course) 1-4

Grade of "C" or better required for all courses in the Certificate of Completion in Editing.

CERTIFICATE OF COMPLETION IN FILM ANALYSIS AND CRITICISM: 45 credits

The Certificate of Completion in Film Analysis and Criticism is designed for students who plan to enter the field of Motion Picture/Television Production as script analysts, reviewers, and film feature writers. Students will receive hands-on training in motion picture production and will write short screenplays, as well as a variety of material analyzing film content and execution. In addition, they will acquire knowledge of film histories and various subcategories of film.

PROGRAM PREREQUISITES: 9 credits

ENG101 First-Year Composition (3) OR
ENG107 First-Year Composition for ESL (3) 3
ENG102 First-Year Composition (3) OR
ENG108 First-Year Composition for ESL (3) 3
TCM100 Digital Multimedia (3) OR
waived by permission of Program Director 3

REQUIRED COURSES: 36 credits

ENG210 Creative Writing 3
HUM/THE205 Introduction to Cinema 3
HUM/WST209 Women and Films (3) OR
TCM225 Film Noir (3) 3
HUM/THE210 Contemporary Cinema 3
HUM211AA Foreign Films: Classics 3
JRN201 Newswriting 3
TCM101 Fundamentals of Radio and Television 3
TCM111 Screenwriting I 3
TCM134 Pre-Production for Motion Picture and Television 3
TCM135 Production for Motion Picture and Television 3
TCM136 Post-Production for Motion Picture and Television 3
TCM140 Modern Media Concepts 3

RESTRICTED ELECTIVES: 9 credits

ENH254 Literature and Film 3
JRN234 Feature Writing 3
TCM213 Motion Picture Workshop 4
TCM214 Television Workshop 3
TCM230 Motion Picture Directing 4
TCM285++ Special Topics: Motion Picture/TV Production (any module).. 1-3
TCM296++ Cooperative Education (any suffixed course) 1-4
THP112 Acting I 3

Grade of "C" or better required for all courses in the Certificate of Completion in Film Analysis and Criticism.

Scottsdale Community College Programs

MUSIC

Music Department MB 144 (480) 423-6333
 Program Director, Dr. Steve Green MB 143 (480) 423-6745

Two certificate/degree programs offer students an opportunity to receive training in the commercial music business. Through the Audio Production Technologies program, students will receive training on industry-standard equipment by instructors with real-world experience and professional resumes. The Music Business program is designed to prepare students for today's music industry, combining a flexible curriculum with an emphasis in business and marketing, along with music industry-related courses.

CERTIFICATE OF COMPLETION IN AUDIO PRODUCTION TECHNOLOGIES: 37-38 credits

REQUIRED COURSES: 37-38 credits

MTC101	Introduction to Music Theory (3) OR	
MTC103	Introduction to Aural Perception (2)	2-3
MTC180	Computer Literacy for Musicians (3) OR	
MUC295	Studio Music Recording III (3)	3
MTC191	Electronic Music I	3
MTC192	Electronic Music II	3
MUC109	Music Business: Merchandising and the Law	3
MUC110	Music Business: Recording and Mass Media	3
MUC111	Digital Audio Workstation I (DAW I)	3
MUC112	Digital Audio Workstation II (DAW II)	3
MUC195	Studio Music Recording I	3
MUC196	Studio Music Recording II	3
MUC197	Live Sound Reinforcement I	3
MUC198	Live Sound Reinforcement II	3
MUC297AB	Music Internship	2

Grade of "C" or better required for all courses in the Certificate of Completion in Audio Production Technologies.

AAS IN AUDIO PRODUCTION TECHNOLOGIES: 65-66 credits

REQUIRED COURSES: 37-38 credits

MTC101	Introduction to Music Theory (3) OR	
MTC103	Introduction to Aural Perception (2)	2-3
MTC180	Computer Literacy for Musicians (3) OR	
MUC295	Studio Music Recording III (3)	3
MTC191	Electronic Music I	3
MTC192	Electronic Music II	3
MUC109	Music Business: Merchandising and the Law	3
MUC110	Music Business: Recording and Mass Media	3
MUC111	Digital Audio Workstation I (DAW I)	3
MUC112	Digital Audio Workstation II (DAW II)	3
MUC195	Studio Music Recording I	3
MUC196	Studio Music Recording II	3
MUC197	Live Sound Reinforcement I	3
MUC198	Live Sound Reinforcement II	3
MUC297AB	Music Internship	2

GENERAL EDUCATION (G.E.) REQUIREMENTS: 28 credits

CORE: 15 credits

First-Year Composition

Any approved G. E. courses from the First-Year Composition area 6

Oral Communication

Any approved G. E. course from the Oral Communication area 3

Critical Reading

CRE101 Critical and Evaluative Reading I (3) OR
 Equivalent by assessment 3

Mathematics

Any approved G. E. course from the Mathematics area 3

DISTRIBUTION: 13 credits

Humanities and Fine Arts

Any approved G. E. courses from the Humanities and Fine Arts area 6
 Note: MHL140 or MHL145 or MHL153 recommended.

Natural Sciences

Any approved G. E. course from the Natural Sciences area 4

MTC, MUC

Social and Behavioral Sciences

Any approved G. E. course from the Social/Behavioral Sciences area 3
 Grade of "C" or better required for all courses in the AAS in Audio Production Technologies.

CERTIFICATE OF COMPLETION IN MUSIC BUSINESS: 40 credits

REQUIRED COURSES: 37 credits

ACC109	Accounting Concepts (3) OR	
ACC111	Accounting Principles I (3)	3
BPC128	Introduction to Desktop Publishing	1
CIS131AA	Doing Business on the Internet	1
COM259	Communication in Business and Professions	3
GBS151	Introduction to Business	3
MGT253	Owning and Operating a Small Business	3
MKT271	Principles of Marketing	3
MTC101	Introduction to Music Theory or Higher Level	3
MUC109	Music Business: Merchandising and the Law	3
MUC110	Music Business: Recording and Mass Media	3
MUC111	Digital Audio Workstation I (DAW I)	3
MUC195	Studio Music Recording I	3
MUC295AA	Self Promotion for Music	1
MUC297AB	Music Internship	2
SBS230	Financial and Tax Management for Small Business	2

RESTRICTED ELECTIVES: 3 credits

MHL+++ Any approved MHL prefixed course 3

Grade of "C" or better required for all courses in the Certificate of Completion in Music Business.

AAS IN MUSIC BUSINESS: 65 credits

REQUIRED COURSES: 37 credits

ACC109	Accounting Concepts (3) OR	
ACC111	Accounting Principles I (3)	3
BPC128	Introduction to Desktop Publishing	1
CIS131AA	Doing Business on the Internet	1
COM259	Communication in Business and Professions	3
GBS151	Introduction to Business	3
MGT253	Owning and Operating a Small Business	3
MKT271	Principles of Marketing	3
MTC101	Introduction to Music Theory or Higher Level	3
MUC109	Music Business: Merchandising and the Law	3
MUC110	Music Business: Recording and Mass Media	3
MUC111	Digital Audio Workstation I (DAW I)	3
MUC195	Studio Music Recording I	3
MUC295AA	Self Promotion for Music	1
MUC297AB	Music Internship	2
SBS230	Financial and Tax Management for Small Business	2

RESTRICTED ELECTIVES: 3 credits

MHL+++ Any approved MHL prefixed course 3

GENERAL EDUCATION (G.E.) REQUIREMENTS: 25 credits

CORE: 15 credits

First-Year Composition

Any approved G. E. courses from the First-Year Composition area 6

Oral Communication

Any approved G. E. course from the Oral Communication area 3

Critical Reading

CRE101 Critical and Evaluative Reading I (3) OR
 Equivalent by assessment 3

Mathematics

Any approved G. E. course from the Mathematics area 3

DISTRIBUTION: 10 credits

Humanities and Fine Arts

Any approved G. E. course from the Humanities and Fine Arts area 3

Natural Sciences

Any approved G. E. course from the Natural Sciences area 4

Social and Behavioral Sciences

Any approved G. E. course from the Social/Behavioral Sciences area 3

Grade of "C" or better required for all courses in the AAS in Music Business.

Scottsdale Community College Programs

NURSING SCIENCE

Health Sciences Division Office SB 132 (480) 423-6225

The Nursing Program is available at eight of the Maricopa Community Colleges. The nursing pathway provides multiple exit points for employment that begins with the Nurse Assisting course and continues to the Practical Nurse certificate and Registered Nurse degree program. The Nursing Program provides eligibility for students seeking certification and licensure through the Arizona State Board of Nursing. Licensure requirements are the exclusive responsibility of the Arizona State Board of Nursing.

The Nursing Program is approved by the Arizona State Board of Nursing and accredited by the National League for Nursing Accrediting Commission (NLNAC), 61 Broadway 33rd Floor, New York, New York 10006, 212.363.5555, ext. 153.

Program Offerings:

This program is offered at the following sites:

Chandler Gilbert Community College.....	480-988-8880
GateWay Community College	602-286-8686
Glendale Community College	623-845-3210
Mesa Community College	480-461-7106
Mesa Community College/Boswell	623-974-7835
Paradise Valley Community College	602-787-7284
Phoenix College	602-285-7110
Rio Salado College	480-517-8580
Scottsdale Community College	480-423-6225

Waiver of Licensure/Certification Guarantee:

Admission or graduation from the Nursing Program does not guarantee obtaining a license or certificate to practice nursing. Licensure and certification requirements and the subsequent procedures are the exclusive right and responsibility of the Arizona State Board of Nursing. Students must satisfy the requirements of the Nurse Practice Act: Statutes, Rules and Regulations, independently of any college of school requirements for graduation.

Pursuant to A.R.S. § 32-1606(B)(17), an applicant for professional or practical nurse license by examination is not eligible for licensure if the applicant has any felony convictions and has not received an absolute discharge from the sentences for all felony convictions. The absolute discharge must be received five or more years before submitting this application. If you cannot prove that the absolute discharge date is five or more years, the Board cannot process your application.

All nurse and nursing assistant applicants for certification and licensure will be fingerprinted to permit the Department of Public Safety to obtain state and federal criminal history information. If there is any question about eligibility for licensure or certification, contact the nursing education consultant at the Arizona State Board of Nursing (602-331-8111). All students must submit a copy of a fingerprint clearance card with their application for the Maricopa Community College District Nursing Program.

Health Declaration:

It is essential that Nursing students be able to perform a number of physical activities in the clinical portion of the program. At a minimum, students will be required to lift patients, stand for several hours at a time and perform bending activities. The clinical nursing experience also places students under considerable mental and emotional stress as they undertake responsibilities and duties impacting patients' lives. Students must be able to demonstrate rational and appropriate behavior under stressful conditions. Individuals should give careful consideration to the mental and physical demands of the program prior to making application.

NUR

Health and Safety Requirements for the Nursing Program:

1. Students must submit a completed Health and Safety Documentation Checklist and maintain current status throughout the program.
2. Students must submit CPR card for Health Care Provider and maintain current status throughout the program.
3. Health Declaration Form signed by a licensed health care provider.
4. Negative urine drug screen.

Grade Requirements:

Student must obtain a **C** grade or better or pass in **P/Z** graded courses in all courses in program.

Course Fee Information:

Please see class schedule for information regarding course fees.

University Transfer Students:

For students planning a University Program

Students who are planning to earn the Bachelor of Science in Nursing may obtain their prerequisite courses at Maricopa Community Colleges. For information on courses that meet requirements for admission into a baccalaureate nursing program, please contact a program advisor.

THE NURSE ASSISTING PATHWAY

The nurse assisting pathway is designed to prepare students to complete the Nurse Assistant Certification through the Arizona State Board of Nursing to practice in a health care agency as a certified nurse assistant. Completion of the nurse assistant program of study provides job ready skills as a nursing assistant. Students may apply to the Nursing Program after completing the prerequisite courses and admission requirements.

PRACTICAL NURSE PATHWAY

Following completion of the practical nurse level program of study, the student is eligible to apply for licensure as a practical nurse. Licensed Practical Nurses (LPN) are employed in acute, long-term, and community-based health care agencies under the direction of a registered nurse. Practical Nurses function within their legal scope of practice and use professional standards of care in illness care and health promotion activities for clients and families across the life span.

REGISTERED NURSE PATHWAY

The Associate in Applied Science (AAS) degree in Nursing graduate is eligible to apply for licensure as a Registered Nurse (RN). The RN is educated as a generalist who delivers health care to clients and family groups and has competencies related to the art and science of nursing. The RN may be employed in a variety of acute, chronic and community-based health care settings. The AAS degree in Nursing provides the graduate with an educational foundation for articulation into the university setting.

Scottsdale Community College Programs

THE NURSE ASSISTING PATHWAY

Certificate of Completion in Nurse Assisting: 8 Credits

ADMISSION CRITERIA:

Application and acceptance into the program, high school graduate or GED, current Health Care Provider CPR Card required before beginning courses.

All students must submit a copy of a fingerprint clearance card with their application for the Maricopa Community College District Nursing Program.

PROGRAM PREREQUISITES: None

REQUIRED COURSES: 8 credits

HCC130	Fundamentals in Health Care Delivery (3) OR	
HCC130AA	Health Care Today (0.5) AND	
HCC130AB	Workplace Behaviors in Health Care (0.5) AND	
HCC130AC	Personal Wellness and Safety (0.5) AND	
HCC130AD	Communication/Teamwork in Health Care Organizations (0.5) AND	
HCC130AE	Legal Issues in Health Care (0.5) AND	
HCC130AF	Decision Making in the Health Care Setting (0.5)	3
HCC145AA	Medical Terminology for Health Care Workers I	1
NUR156	Nurse Assisting+	2
NUR157	Nurse Assisting Lab+	2

Note: + indicates course has prerequisites and/or corequisites.

Students must earn a grade of "C" or better in all courses within the program.

PRACTICAL NURSE PATHWAY

Certificate of Completion in Practical Nursing: 44 - 57 Credits

ADMISSION CRITERIA:

High school diploma or GED, application and acceptance into the nursing program.

A reading score of 50% or higher and a math score of 50% or higher on the Nursing Entrance Exam (NET) must be achieved for admission. Retests can be taken only once in a 60-day period. The entire Nursing Entrance Exam (NET) must be taken on each retrest. The test can be taken no more than 3 times in a 12-month period.

All students must submit a copy of a fingerprint clearance card with their application for the Nursing Program.

PROGRAM PREREQUISITES: 18-31 credits

Note: The credit hour range is subject to change depending on the student's educational experience.

BIO156	Introductory Biology for Allied Health (4) OR	
BIO181	General Biology (Majors) I (4) OR	
	One year of high school biology	0-4
BIO201	Human Anatomy and Physiology I+	4
BIO202	Human Anatomy and Physiology II+	4
BIO205	Microbiology+	4
CHM130	Fundamental Chemistry+ (3) AND	
CHM130LL	Fundamental Chemistry Lab+ (1) OR	
	One year of high school chemistry	0-4
CRE101	Critical and Evaluative Reading I+ (3) OR	
	Equivalent by assessment	0-3
ENG101	First-Year Composition+ (3) OR	
ENG107	First-Year Composition for ESL+ (3)	3
MAT120/121/122	Intermediate Algebra+ OR	
	Higher level math course	3-5

REQUIRED COURSES: 26 credits

HCC145AA	Medical Terminology for Health Care Workers I	1
NUR111	Nursing Process/Critical Thinking I+	4
NUR117	Pharmacology and Medication Administration I+	2
NUR119	Nursing Science I+	5
NUR121	Nursing Process/Critical Thinking II+	4
NUR127	Pharmacology and Medication Administration II+	2
NUR129	Nursing Science II+	5
PSY101	Introduction to Psychology	3

Note: + indicates course has prerequisites and/or corequisites.

Students must earn a grade of "C" or better in all courses within the program.

REGISTERED NURSE PATHWAY

Associate in Applied Science in Nursing: 69 - 82 Credits

ADMISSION CRITERIA:

- High school diploma or GED, application and acceptance into the Nursing program.
- A reading score of 50% or higher and a math score of 50% or higher on the Nursing Entrance Exam (NET) must be achieved for admission. Retests can be taken only once in a 60-day period. The entire Nursing Entrance Exam (NET) must be taken on each retrest. The test can be taken no more than 3 times in a 12-month period.
- The Health Education Systems, Inc. (HESI) test will be administered to all prospective advanced placement students seeking admission into Blocks 3 or 4. A score of 800 or higher is required in order to be granted advanced placement into either of these blocks. A score of less than 800 will result in placement into either Block 1 or 2. The final decision rests with the Nursing Program Chair at the college to which the student is accepted.
- All students must submit a copy of a fingerprint clearance card with their application for the Nursing Program.

PROGRAM PREREQUISITES: 18-31 credits

Note: The credit hour range is subject to change depending on the student's educational experience.

BIO156	Introductory Biology for Allied Health (4) OR	
BIO181	General Biology (Majors) I (4) OR	
	One year of high school biology	0-4
BIO201	Human Anatomy and Physiology I+	4
BIO202	Human Anatomy and Physiology II+	4
BIO205	Microbiology+	4
CHM130	Fundamental Chemistry+ (3) AND	
CHM130LL	Fundamental Chemistry Lab+ (1) OR	
	One year of high school chemistry	0-4
CRE101	Critical and Evaluative Reading I+ (3) OR	
	Equivalent by assessment	0-3
ENG101	First-Year Composition+ (3) OR	
ENG107	First-Year Composition for ESL+ (3)	3
MAT120/121/122	Intermediate Algebra+ OR	
	Higher level math course	3-5

REQUIRED COURSES: 46 credits

HCC145AA	Medical Terminology for Health Care Workers I	1
NUR111	Nursing Process/Critical Thinking I+	4
NUR117	Pharmacology and Medication Administration I+	2
NUR119	Nursing Science I+	5
NUR121	Nursing Process/Critical Thinking II+	4
NUR127	Pharmacology and Medication Administration II+	2
NUR129	Nursing Science II+	5
NUR231	Nursing Process/Critical Thinking III+	4
NUR237	Pharmacology and Medication Administration III+	1
NUR239	Nursing Science III+	5
NUR241	Nursing Process & Critical Thinking IV+	4
NUR249	Nursing Science IV+	6
PSY101	Introduction to Psychology	3

Continued next page...

Scottsdale Community College Programs

GENERAL EDUCATION (G.E.) REQUIREMENTS: 5 credits

CORE: 3 credits

First-Year Composition

Met by ENG101 OR ENG107 in Program Prerequisites area 0

ENG102 First-Year Composition+ (3) OR

ENG108 First-Year Composition for ESL+ (3) 3

Oral Communication

Waived 0

Critical Reading

Met by CRE101 in Program Prerequisites area 0

Mathematics

Met by MAT120 or MAT121 or MAT122 OR

higher level math course in Program Prerequisites area 0

DISTRIBUTION: 2 credits

Humanities and Fine Arts

Any approved G. E. course from the Humanities and Fine Arts area 2

Natural Sciences

Met by BIO201 and BIO202 in Program Prerequisites area 0

Social and Behavioral Sciences

Met by PSY101 in Required Courses area 0

Note: + indicates course has prerequisites and/or corequisites.

Students must earn a grade of "C" or better in all courses within the program.

OFFICE AUTOMATION SYSTEMS

OAS

Business Division Office AP 237A (480) 423-6253
 Program Director, Pat Serrano CM 416 (480) 423-6264

The two-year AAS in Office Automation Systems is designed to prepare students for positions as administrative assistants and executive secretaries. The Certificate of Completion in Office Automation Systems is composed of two semesters of course work, emphasizing microcomputer operations using a variety of applications, and learning to function as a professional in the office of today.

The Certificate of Completion in Office Fundamentals, which is one semester in length, is designed to prepare students to perform satisfactory word processing applications and functions as an entry-level employee in a professional office.

Students who have completed courses in the skill areas prior to enrollment in the program may begin at a more advanced level and may substitute business electives after consulting with an advisor in the Office Automation Systems area.

The Certificate of Completion in Word Processing prepares individuals to assume productive positions in the field of word processing. Integrated concepts of modern office systems are included in the program.

CERTIFICATE OF COMPLETION IN OFFICE FUNDAMENTALS: 15 credits

REQUIRED COURSES: 15 credits

BPC110 Computer Usage and Applications 3
 BPC/CIS133AA Internet/Web Development Level I-A 1
 BPC/OAS135++ Any Word Processing module 2
 OAS101 Computer Typing I: Keyboarding and Formatting 3
 OAS108 Business English 3
 OAS125 Introduction to the Professional Office 3

Grade of "C" or better required for all courses in the Certificate of Completion in Office Fundamentals.

CERTIFICATE OF COMPLETION IN WORD PROCESSING: 18 credits

REQUIRED COURSES: 18 credits

BPC110 Computer Usage and Applications 3
 BPC/CIS121AB Microsoft Command Line Operations (1) OR
 BPC/CIS121AE Windows Operating System: Level I (1) 1
 BPC/CIS133AA Internet/Web Development Level I-A 1
 BPC/OAS135++ Any Word Processing module 2
 BPC/OAS235++ Any Advanced Word Processing module 2
 OAS101 Computer Typing I: Keyboarding and Formatting 3
 OAS108 Business English 3
 OAS125 Introduction to the Professional Office 3

Grade of "C" or better required for all courses in the Certificate of Completion in Word Processing.

Scottsdale Community College Programs

CERTIFICATE OF COMPLETION IN OFFICE AUTOMATION SYSTEMS: 31 credits

REQUIRED COURSES: 31 credits

ACC111	Accounting Principles I	3
BPC110	Computer Usage and Applications	3
BPC/CIS114++	Any Spreadsheet module	1
BPC/CIS121AB	Microsoft Command Line Operations (1) OR	
BPC/CIS121AE	Windows Operating System: Level I (1)	1
BPC/CIS133AA	Internet/Web Development Level I-A	1
BPC/OAS135++	Any Word Processing module	2
BPC/OAS235++	Any Advanced Word Processing module	2
GBS151	Introduction to Business	3
GBS175	Professional Development	3
OAS101	Computer Typing I: Keyboarding and Formatting	3
OAS108	Business English	3
OAS125	Introduction to the Professional Office	3
OAS296WC	Cooperative Education	3

Grade of "C" or better required for all courses in the Certificate of Completion in Office Automation Systems.

AAS IN OFFICE AUTOMATION SYSTEMS: 64-66 credits

REQUIRED COURSES: 39 credits

ACC111	Accounting Principles I	3
ACC115	Computerized Accounting	2
BPC110	Computer Usage and Applications	3
BPC/CIS114++	Any Spreadsheet module	1
BPC/CIS121AB	Microsoft Command Line Operations (1) OR	
BPC/CIS121AE	Windows Operating System: Level I (1)	1
BPC/CIS133AA	Internet/Web Development Level I-A	1
BPC/OAS135++	Any Word Processing module	2
BPC/OAS235++	Any Advanced Word Processing module	2
GBS151	Introduction to Business	3
GBS175	Professional Development	3
GBS233	Business Communication	3
MGT251	Human Relations in Business	3
OAS101	Computer Typing I: Keyboarding and Formatting	3
OAS108	Business English	3
OAS125	Introduction to the Professional Office	3
OAS296WC	Cooperative Education	3

GENERAL EDUCATION (G.E.) REQUIREMENTS: 25-27 credits

CORE: 15-17 credits

First-Year Composition

ENG101	First-Year Composition (3) AND	
ENG102	First-Year Composition (3)	6

Oral Communication

COM110	Interpersonal Communication	3
--------	-----------------------------	---

Critical Reading

CRE101	Critical and Evaluative Reading I (3) OR equivalent as indicated by assessment.	3
--------	--	---

Mathematics

	Any approved G. E. course from the Mathematics area	3-5
--	---	-----

DISTRIBUTION: 10 credits

Humanities and Fine Arts

	Any approved G. E. course from the Humanities and Fine Arts area	3
--	--	---

Natural Sciences

	Any approved G. E. course from the Natural Sciences area	4
--	--	---

Social and Behavioral Sciences

	Any approved G. E. course from the Social/Behavioral Sciences area	3
--	--	---

Grade of "C" or better required for all courses in the AAS in Office Automation Systems.

RECREATION MANAGEMENT

PED, REC

HPERD DIVISION	PE 155	(480) 423-6606
Program Director, Dave Brown	PE 107	(480) 423-6617

CERTIFICATE OF COMPLETION IN RECREATION MANAGEMENT: 39-43 credits

The Certificate of Completion in Recreation Management is designed to prepare students with entry level skills for the expanding field of recreation. The program provides a foundation for the positive application of play, recreation, and leisure across the life span. Through classroom and experiential learning activities, students gain knowledge of and practical experience in the programming and delivery of recreation services, and develop communication, group facilitation, management and leadership skills. Participation in recreation activity courses equips students with the technical skills necessary to plan, lead and facilitate safe outdoor recreation adventures and programs.

REQUIRED COURSES: 33-37 credits

BPC110	Computer Usage and Applications (3) OR	
CIS105	Survey of Computer Information Systems (3)	3
COM100	Introduction to Human Communications (3) OR	
COM110	Interpersonal Communication (3)	3
HES154	First Aid/Cardiopulmonary Resuscitation	3
MGT101	Techniques of Supervision (3) OR	
MGT126	Customer Service Skills and Strategies (3)	3
REC120	Leisure and the Quality of Life (3) OR	
REC160	Leisure and Society (3)	3
REC150AB	Outdoor Adventure Skills	3
REC210	Leisure Delivery Systems	3
REC230	Programming of Recreation Services (3) OR	
HRM145	Events Management (3)	3
REC250	Recreation Leadership	3
REC282AA-AC	Volunteerism for Recreation	1-3
REC296WA-WC	Cooperative Education (any module) (1-3) OR	
REC298AA-AC	Special Projects (1-3)	1-3

Physical/Recreational Activities

Note: Students must select four (4) different activities from the following list

PED101BP	Physical Activities: Backpacking (1) OR	
PED102BP	Physical Activities: Backpacking (1) OR	
PED201BP	Physical Activities: Backpacking (1) OR	
PED202BP	Physical Activities: Backpacking (1)	
PED101DL	Physical Activities: Cross Country Skiing (1) OR	
PED102DL	Physical Activities: Cross Country Skiing (1) OR	
PED201DL	Physical Activities: Cross Country Skiing (1) OR	
PED202DL	Physical Activities: Cross Country Skiing (1)	
PED101DX	Physical Activities: Rock Climbing (1) OR	
PED102DX	Physical Activities: Rock Climbing (1) OR	
PED201DX	Physical Activities: Rock Climbing (1) OR	
PED202DX	Physical Activities: Rock Climbing (1)	
PED101ER	Physical Activities: Camping (1) OR	
PED102ER	Physical Activities: Camping (1) OR	
PED201ER	Physical Activities: Camping (1) OR	
PED202ER	Physical Activities: Camping (1)	
PED101GF	Physical Activities: Cycling (1) OR	
PED102GF	Physical Activities: Cycling (1) OR	
PED201GF	Physical Activities: Cycling (1) OR	
PED202GF	Physical Activities: Cycling (1)	
PED101LK	Physical Activities: Hiking (1) OR	
PED102LK	Physical Activities: Hiking (1) OR	
PED201LK	Physical Activities: Hiking (1) OR	
PED202LK	Physical Activities: Hiking (1)	

Scottsdale Community College Programs

PED101PT	Physical Activities: Mountain Biking the Southwest (1) OR	
PED102PT	Physical Activities: Mountain Biking the Southwest (1) OR	
PED201PT	Physical Activities: Mountain Biking the Southwest (1) OR	
PED202PT	Physical Activities: Mountain Biking the Southwest (1)	
PED101RL	Physical Activities: Recreational Sports (1) OR	
PED102RL	Physical Activities: Recreational Sports (1) OR	
PED201RL	Physical Activities: Recreational Sports (1) OR	
PED202RL	Physical Activities: Recreational Sports (1)	
REC155++	Any recreational activity modules	
RESTRICTED ELECTIVES: 6 credits		
AIS/MGT113	Proposal Writing	3
ARH145	History of American Indian Art	3
COM263	Elements of Intercultural Communication	3
COM281	Communication Activities	1
CPD102AS	Conflict Resolution	2
CPD103BL	Dynamics of Leadership (2) OR	
LDR101	Emerging Leaders I (2)	2
GBS120	Workplace Communication Skills	3
GCU221	Arizona Geography	3
HES100	Healthful Living	3
HIS105	Arizona History	3
HIS106	Southwest History	3
HRM110	Introduction to Hospitality and Tourism Management	3
PED265	Theory of Coaching	3
Grade of "C" or better required for all courses in the Certificate of Completion in Recreation Management.		

AAS IN RECREATION MANAGEMENT: 60-64 credits

The Associate in Applied Science in Recreation Management is designed to prepare students for entry level positions in the recreation field and provides the first half of a four-year undergraduate program of study in Recreation Management and/or Leadership. The program focuses on the positive application of play, recreation, and leisure across the life span. Along with required general education courses, the program includes foundational and practical experience in the programming and delivery of recreational services and the development of communication, group facilitation, management, leadership and technical skills.

REQUIRED COURSES: 32-34 credits

BPC110	Computer Usage and Applications (3) OR	
CIS105	Survey of Computer Information Systems (3)	3
COM100	Introduction to Human Communications (3) OR	
COM110	Interpersonal Communication (3)	3
HES154	First Aid/Cardiopulmonary Resuscitation	3
MGT101	Techniques of Supervision (3) OR	
MGT126	Customer Service Skills and Strategies (3)	3
REC120	Leisure and the Quality of Life (3) OR	
REC160	Leisure and Society (3)	3
REC150AB	Outdoor Adventure Skills	3
REC210	Leisure Delivery Systems	3
REC230	Programming of Recreation Services (3) OR	
HRM145	Events Management (3)	3
REC250	Recreation Leadership	3
REC282AA-AC	Volunteerism for Recreation	1-3

Physical/Recreational Activities

Note: Students must select four (4) different activities from the following list

PED101BP	Physical Activities: Backpacking (1) OR	
PED102BP	Physical Activities: Backpacking (1) OR	
PED201BP	Physical Activities: Backpacking (1) OR	
PED202BP	Physical Activities: Backpacking (1)	
PED101DL	Physical Activities: Cross Country Skiing (1) OR	
PED102DL	Physical Activities: Cross Country Skiing (1) OR	
PED201DL	Physical Activities: Cross Country Skiing (1) OR	
PED202DL	Physical Activities: Cross Country Skiing (1)	

PED101DX	Physical Activities: Rock Climbing (1) OR	
PED102DX	Physical Activities: Rock Climbing (1) OR	
PED201DX	Physical Activities: Rock Climbing (1) OR	
PED202DX	Physical Activities: Rock Climbing (1)	
PED101ER	Physical Activities: Camping (1) OR	
PED102ER	Physical Activities: Camping (1) OR	
PED201ER	Physical Activities: Camping (1) OR	
PED202ER	Physical Activities: Camping (1)	
PED101GF	Physical Activities: Cycling (1) OR	
PED102GF	Physical Activities: Cycling (1) OR	
PED201GF	Physical Activities: Cycling (1) OR	
PED202GF	Physical Activities: Cycling (1)	
PED101LK	Physical Activities: Hiking (1) OR	
PED102LK	Physical Activities: Hiking (1) OR	
PED201LK	Physical Activities: Hiking (1) OR	
PED202LK	Physical Activities: Hiking (1)	
PED101PT	Physical Activities: Mountain Biking the Southwest (1) OR	
PED102PT	Physical Activities: Mountain Biking the Southwest (1) OR	
PED201PT	Physical Activities: Mountain Biking the Southwest (1) OR	
PED202PT	Physical Activities: Mountain Biking the Southwest (1)	
PED101RL	Physical Activities: Recreational Sports (1) OR	
PED102RL	Physical Activities: Recreational Sports (1) OR	
PED201RL	Physical Activities: Recreational Sports (1) OR	
PED202RL	Physical Activities: Recreational Sports (1)	
REC155++	Any recreational activity modules	

RESTRICTED ELECTIVES: 6 credits

AIS/MGT113	Proposal Writing	3
ARH145	History of American Indian Art	3
COM263	Elements of Intercultural Communication	3
COM281	Communication Activities	1
CPD102AS	Conflict Resolution	2
CPD103BL	Dynamics of Leadership (2) OR	
LDR101	Emerging Leaders I (2)	2
GBS120	Workplace Communication Skills	3
GCU221	Arizona Geography	3
HES100	Healthful Living	3
HIS105	Arizona History	3
HIS106	Southwest History	3
HRM110	Introduction to Hospitality and Tourism Management	3
PED265	Theory of Coaching	3

GENERAL EDUCATION (G.E.) REQUIREMENTS: 22-24 credits

CORE: 12-14 credits

First-Year Composition

Any approved G. E. courses from the First-Year Composition area

Oral Communication

Met by COM100 or COM110 in the Required Courses area

Critical Reading

CRE101	Critical and Evaluative Reading I (3) OR	
	Equivalent by assessment.	3

Mathematics

Any approved G. E. course from the Mathematics area

DISTRIBUTION: 10 credits

Humanities and Fine Arts

Any approved G. E. courses from the Humanities and Fine Arts area

Natural Sciences

Any approved G. E. course from the Natural Sciences area

Social and Behavioral Sciences

Any approved G. E. course from the Social/Behavioral Sciences area

Grade of "C" or better required for all courses in the AAS in Recreation Management.

Scottsdale Community College Programs

RETAIL MANAGEMENT AND MARKETING MGT, MKT

Business Division Office AP 237A (480) 423-6253

CERTIFICATE OF COMPLETION IN RETAIL MANAGEMENT AND MARKETING: 39 credits

Students can earn a Certificate of Completion in Retail Management and Marketing. Please see page 79 for detailed information on the required coursework.

AAS IN BUSINESS: 64-66 credits

Students can earn an AAS degree in Business with a specialization in Retail Management and Marketing. Please see page 78, "Business" for detailed information on the required coursework.

RETAIL MANAGEMENT Districtwide Program

Business Division Office AP 237A (480) 423-6253
Program Contact, Norma Johansen AP 240 (480) 423-6272

The Associate in Applied Science in Retail Management is designed to prepare individuals working in the retail management, food industry, and related fields, for the mid-level management position challenges of the future. The curriculum encompasses business essentials and also emphasizes the skill sets needed for effective management and communication in the work environment. Instruction will provide the background and knowledge necessary for students to develop the judgment skills they must exercise as business managers.

ASSOCIATE IN APPLIED SCIENCE IN RETAIL MANAGEMENT: 64 credits

REQUIRED COURSES: 39 credits

ACC111	Accounting Principles I	3
ACC230	Uses of Accounting Information I	3
ACC240	Uses of Accounting Information II	3
BPC110	Computer Usage and Applications (3) OR	
CIS105	Survey of Computer Information Systems (3)	3
COM110	Interpersonal Communication (3) OR	
IND133	Speaking in Business (3)	3
GBS110	Human Relations in Business and Industry (3) OR	
MGT251	Human Relations in Business (3)	3
GBS131	Business Calculations (3) OR	
GBS161	Mathematics in Business (3)	3
GBS205	Legal, Ethical, and Regulatory Issues in Business	3
GBS233	Business Communication	3
MGT101	Techniques of Supervision (3) OR	
MGT229	Management and Leadership (3)	3
MGT179	Utilizing the Human Resources Department (3) OR	
MGT276	Personnel/Human Resources Management (3)	3
MKT268	Merchandising	3
MKT271	Principles of Marketing	3

GENERAL EDUCATION (G.E.) REQUIREMENTS: 25 credits

CORE: 15 credits

First-Year Composition

ENG101	First-Year Composition (3) OR	
ENG107	First-Year Composition for ESL (3) AND	
ENG102	First-Year Composition (3) OR	
ENG108	First-Year Composition for ESL (3) OR	
ENG111	Technical Writing (3)	6

ENG102 or ENG108 recommended for students pursuing a BAS degree at an Arizona university.

Oral Communication

COM230	Small Group Communication	3
--------	---------------------------------	---

Critical Reading

CRE101	Critical and Evaluative Reading I (3) OR	
	Equivalent by assessment	3

Mathematics

MAT102	Mathematical Concepts/Applications (3) OR	
	Satisfactory completion of a higher level mathematics course	3-5

DISTRIBUTION: 10 credits

Humanities and Fine Arts

	Any approved G. E. course from the Humanities and Fine Arts area	3
--	--	---

Natural Sciences

	Any approved G. E. course from the Natural Sciences area	4
--	--	---

Social and Behavioral Sciences

SBU200	Society and Business	3
--------	----------------------------	---

Grade of "C" or better required for all courses in the AAS in Retail Management.

SMALL BUSINESS MANAGEMENT SBS

Business Division Office AP 237A (480) 423-6253

CERTIFICATE OF COMPLETION IN SMALL BUSINESS MANAGEMENT: 24 credits

Students can earn a Certificate of Completion in Small Business Management. Please see page 79 for detailed information on the required coursework.

AAS IN BUSINESS: 64-66 credits

Students can earn an AAS degree in Business with a specialization in Small Business Management. Please see page 78, "Business" for detailed information on the required coursework.

Scottsdale Community College Programs

TEACHER EDUCATION PARTNERSHIP (SCOTTSDALE) EDU

Social/Behavioral Sciences Division Office SB 130 (480) 423-6206
 Program Director, Dr. Bobbie Sferra SB121 (480) 423-6217

SCC offers a program that allows people with bachelor's degrees to become teachers in one year. The fast-track schedule is designed to help ease Arizona's teacher shortage. This program was developed in collaboration with local elementary schools, and allows professors and master teachers to work together to teach and mentor prospective teachers.

This teacher-in-training model is based on the conviction that future teachers must have lengthy experience in schools to practice what they've been learning in college. The immersion concept allows one-third of the time at SCC for classes and the remaining two-thirds of the time working side-by-side with teachers in classrooms. The accelerated 45 credits required for certification in elementary education is completed through full-time participation in one summer session and two full semesters. Students spend approximately 20 hours per week in structured field experiences at schools.

Applications into this program are accepted from adults who have earned a bachelor's degree in any discipline and who are seeking a career in the teaching profession. For further information on this program, contact the program director at (480) 423-6217. (Registration for all courses require approval by the program director.)

Post-Baccalaureate Teacher Certification Immersion Program

One-year Fast-track Program (summer, fall, and spring) to complete requirements for elementary teacher certification.

PROGRAM PREREQUISITES: Bachelor's Degree

REQUIRED COURSES: 45 credits

EDU222	Introduction to the Exceptional Learner	3
EDU225	Foundations for Serving English Language Learners (ELL) ...	3
EDU240	Methods for Teaching Structured English Immersion (SEI) and English as a Second Language (ESL)	3
EDU270	Learning and the Brain	3
EDU270AA	Elementary Reading and Decoding	3
EDU271	Phonics Based Reading and Decoding	3
EDU272	Educational Psychology	3
	(Prerequisites: PSY101)	
EDU276	Classroom Management	3
EDU285	Education Seminar	2
EDU285AA	Education Program Seminar	1
EDU285AB	Current Perspectives in Education	1
EDU288AA	Student Teaching Lab - Elementary	8
EDU290	Science Methods and Curriculum Development	3
EDU293	Mathematics Methods and Curriculum Development	3
EDU295	Social Studies Methods and Curriculum Development	3

THEATRE ARTS

Fine Arts Division Office MB 139 (480) 423-6328

The Theatre Arts curriculum includes study in the following areas: acting, dramatic literature, makeup, play production, theatre history, theatre technology and voice production. Students who enroll in this curriculum do so for both cultural and vocational purposes. Several plays are staged during the year utilizing both traditional and experimental forms. Auditions for these plays are open.

Suggested theatre courses include:

THE111	Introduction to Theatre	3
THE118	Playwriting	3
THE205	Introduction to Cinema (HUM105)	3
THE220	Modern Drama	3
THP112	Acting I	3
THP115	Theatre Makeup	3
THP120AA	Audition Techniques: Prepared Monologue	1
THP120AB	Audition Techniques: Cold Readings	1
THP201AA	Theatre Production I	1
THP210	Acting: TV/Film	3
THP211AA	Creative Drama: Improvisation	1
THP211AB	Creative Drama: Storytelling/Puppets	1
THP212	Acting II	3
THP213	Introduction to Technical Theatre	3
THP214	Directing Techniques	3
THP216	Beginning Stage Lighting	3
THP241	Performance of Literature (COM241)	3
THP243	Interpreter's Theatre (COM243)	3
THP271	Voice and Diction (COM271)	3
THP281	Production and Acting I	3
THP282	Production and Acting II	3

THE and THP

Scottsdale Community College Programs

TRIBAL DEVELOPMENT

Program Director, Manuel F. Pino SB 117 (480) 423-6221

The college, in recognition of its special relationship to the Indian community, offers an innovative program in Tribal Development. The program seeks to prepare individuals to assume positions of management and leadership within tribal communities.

The Associate in Applied Science requirements include courses unique to tribal management in addition to courses which provide a broad preparation in management and supervision. A Certificate of Completion in Tribal Development is also offered.

Tribal Development course descriptions are listed under the various prefixes throughout the catalog.

CERTIFICATE OF COMPLETION IN TRIBAL DEVELOPMENT: 28 credits

REQUIRED COURSES: 28 credits

AIS105	Introduction to American Indian Studies	3
AIS112	American Indian Policy (SOC112)	3
AIS113	Proposal Writing (MGT113)	3
AIS141	Sovereign Indian Nations (SOC141)	3
AIS160	American Indian Law (SOC160)	3
AIS201	Tribal Management Seminar I (MGT201)	1
AIS202	Tribal Management Seminar II (MGT202)	1
CPD103BE	Native American Cultural Pride and Awareness	2
CRE101*	Critical and Evaluative Reading I	3
ENG101	First-Year Composition	3
GBS131	Business Calculations	3

*If the student obtains equivalency by assessment for CRE101, then the student will be required to take COM225 Public Speaking (3 credits) to satisfy the 28-credit hour certificate requirement.

Grade of "C" or better required for all courses in the Certificate of Completion in Tribal Development.

AAS IN TRIBAL DEVELOPMENT: 64-66 credits

REQUIRED COURSES: 31 credits

AIS105	Introduction to American Indian Studies	3
AIS112	American Indian Policy (SOC112)	3
AIS113	Proposal Writing (MGT113)	3
AIS160	American Indian Law (SOC160)	3
AIS201	Tribal Management Seminar I (MGT201)	1
AIS202	Tribal Management Seminar II (MGT202)	1
CPD103BE	Native American Cultural Pride and Awareness	2
GBS131	Business Calculations	3
GBS151	Introduction to Business (3) OR	
PAD103	Introduction to Public Administration (3)	3
MGT101	Techniques of Supervision (3) OR	
MGT175	Business Organization and Management (3)	3
MGT276	Personnel/Human Resource Management	3
MGT296WC	Cooperative Education	3

RESTRICTED ELECTIVES: 8 credits

ACC111	Accounting Principles I (3) OR	
ACC230	Uses of Accounting Information I (3)	3
AIS203	Fundamentals of Economic Development for Indian Tribes (MGT203) ..	3
CIS105	Survey of Computer Information Systems	3
GBS233	Business Communication	3
MGT251	Human Relations in Business	3
MGT296	Cooperative Education module (WB or WC)	2-3

GENERAL EDUCATION (G.E.) REQUIREMENTS: 25-27 credits

CORE: 15-17 credits

First-Year Composition

ENG101	First-Year Composition (3) AND	
ENG102	First-Year Composition (3)	6

Oral Communication

COM225	Public Speaking	3
--------	-----------------------	---

Critical Reading

CRE101	Critical and Evaluative Reading I (3) OR equivalent as indicated by assessment	3
--------	---	---

Mathematics

Any approved G. E. course from the Mathematics area		3-5
---	--	-----

DISTRIBUTION: 10 credits

Humanities and Fine Arts

Any approved G. E. course from the Humanities and Fine Arts area		3
--	--	---

Natural Sciences

Any approved G. E. course from the Natural Sciences area		4
--	--	---

Social and Behavioral Sciences

AIS141	Sovereign Indian Nations (SOC141)	3
--------	---	---

Grade of "C" or better required for all courses in the AAS in Tribal Development.

YOGA INSTRUCTION

PED

HPERD DIVISION PE 155 (480) 423-6606

Program Director, Carlyn Sikes PE 149B (480) 423-6771

The Certificate of Completion in Yoga Instruction prepares students to become qualified yoga instructors. The program provides students with a foundation in the theory, tradition and practice of yoga, knowledge of anatomy and physiology applied to yoga instruction, instructional methodology in the art and science of teaching yoga asanas, and practice teaching experience.

CERTIFICATE OF COMPLETION IN YOGA INSTRUCTION: 22 credits

PROGRAM NOTE: Students must enroll in a Physical Activities: Yoga course each semester.

PROGRAM PREREQUISITES: 1 credit

PED101YJ	Physical Activities: Yoga (1) OR	
PED102YJ	Physical Activities: Yoga (1) OR permission of Program Director	1

REQUIRED COURSES: 19 credits

BIO160	Introduction to Human Anatomy and Physiology	4
PED101YL	Physical Activities: Yoga-Intermediate (1) OR	
PED102YL	Physical Activities: Yoga Intermediate (1) OR	
PED201YL	Physical Activities: Yoga Intermediate (1) OR	
PED202YL	Physical Activities: Yoga Intermediate (1)	4
PED150	Introduction to the Tradition and Practice of Yoga I	2
PED155	Introduction to the Tradition and Practice of Yoga II	2
PED270	Teaching Yoga: Level I	2
PED271	Teaching Yoga: Level II	2
PED272	Teaching Yoga: Alignments and Adjustments	2
PED274	Teaching Yoga: Practicum	1

RESTRICTED ELECTIVES: 3 credits

PED101-202YA	Physical Activities: Astanga Yoga (1) OR	
PED101-202YJ	Physical Activities: Yoga (1) OR	
PED101-202YK	Physical Activities: Kundalini Yoga (1) OR	
PED101-202YP	Physical Activities: Power Yoga (1)	1
PED280	Introduction to Yoga Therapy I	2
PED282	Introduction to Yoga Therapy II	2
WED162	Meditation and Wellness	1

Grade of "C" or better required for all courses in the Certificate of Completion in Yoga Instruction.

Course Descriptions COURSE PREFIX LIST

ACC	Accounting	118	GLG	Geology	169
ADA	Advertising Arts	124	GPH	Physical Geography	169
AES	Aerospace Studies	121	GTC	General Technology	168
AET	Aeronautics	121	HCC	Health Core Curriculum	170
AGS	Agricultural Science	122	HCR	Health Care Related	170
AIS	American Indian Studies	122	HES	Health Science	171
AJS	Administration of Justice Studies	118	HIS	History	172
ARC	Architectural Technology	123	HRM	Hospitality & Tourism Management	173
ARH	Art Humanities	128	HUM	Humanities	174
ART	Art: Computer	124	IBS	International Business	177
ART	Art: Photographic	126	IFS	Information Studies	175
ART	Art: Visual	126	INT	Interior Design	175
ASB	Anthropology (Cultural)	123	ITA	Italian Language	177
ASM	Anthropology (Physical)	123	ITD	Infant/Toddler Development	175
AST	Astronomy	128	JPN	Japanese Language	178
BIO	Biology	129	JRN	Journalism	178
BLT	Building Safety and Construction Technology	130	LDR	Leadership	178
BPC	Business – Personal Computers	132	MAT	Mathematics	180
CCT	Corporate Computer Technology	143	MCO	Mass Communications	180
CET	Civil Engineering Technology	136	MGT	Management	178
CFS	Child/Family Studies	134	MHL	Music: History and Literature	187
CHI	Chinese Language	135	MIS	Military Science	184
CHM	Chemistry	133	MKT	Marketing	179
CIS	Computer Information Systems	137	MST	Microsoft Technology	183
CNT	Cisco Network Technology	136	MTC	Music: Theory and Composition	187
COM	Communication	136	MUC	Music: Commercial and Business	188
CPD	Counseling and Personal Development	143	MUP	Music: Performance/Private Instruction	189
CRE	Critical Reading	144	NCE	Nursing: Continuing Education	191
CSC	Computer Science	142	NUR	Nursing Science	191
CUL	Culinary Arts	145	OAS	Office Automation Systems	194
DAH	Dance Humanities	149	PEL	Physical Education	195
DAN	Dance	147	PHI	Philosophy	194
DFI	Drafting (see ARC prefix above)	123	PHY	Physics	197
ECE	Engineering Science	157	PIM	Pima Language	197
ECH	Early Childhood Development	150	POS	Political Science	197
ECN	Economics	151	PSY	Psychology	198
EDU	Education	152	RDG	Reading	162, 199
EED	Early Education	151	REA	Real Estate	199
EMT	Emergency Medical Technology	155	REC	Recreation	199
ENG	English	158	REL	Religious Studies	200
ENH	English Humanities	162	SBS	Small Business Management	201
EPD	Education Professional Development	154	SBU	Society and Business	131
EPS	Entrepreneurial Studies	164	SLG	Sign Language (American)	200
EQS	Equine Science	164	SOC	Sociology	202
ESL	English as a Second Language	159	SPA	Spanish Language	203
FCS	Family and Consumer Science	165	STO	Storytelling	203
FON	Food and Nutrition	167	TCM	Motion Picture/Television Production	184
FOR	Forensic Science	167	THE	Theatre Arts	204
FRE	French Language	167	THP	Theatre Performance and Production	204
FSC	Fire Science Technology	165	TRS	Translation and Interpretation	206
GBS	General Business	131	WED	Wellness Education	206
GCU	Cultural Geography	168	WST	Women's Studies	206
GER	German Language	170			

COURSE DESCRIPTIONS

ACCOUNTING

ACC

Business Division Office AP 237A (480) 423-6253

ACC105 3 credits 3 periods

Payroll, Sales and Property Taxes

Tax reporting for payroll, sales and personal property. Prerequisites: None.

ACC110 3 credits 3 periods

Understanding and Using Accounting Systems (*Fastrack*)

Develops basic comprehension of the balance sheet, income statement and equity and cash flow statements. Explores usage of specialized journals and subsidiary ledgers in a computerized system. Studies the impact of various transactions on an enterprise, including payroll, receivables, payables, inventory, cash and credit card receipts. Prerequisites: None. (*Offered in both on-campus and online formats.*)

ACC111 3 credits 3 periods

Accounting Principles I

Fundamental theory of accounting principles and procedures. Prerequisites: None.

ACC112 3 credits 3 periods

Accounting Principles II

Continuation of the fundamental theory of accounting principles and procedures, including interpretation of general purpose financial statements. Prerequisites: ACC111 with a grade of C or better, or permission of department/division.

ACC115 2 credits 3 periods

Computerized Accounting

Mastery of a microcomputer accounting system including the general ledger, accounts receivable, accounts payable and payroll. Prerequisites: ACC107, or higher-level accounting course, or permission of instructor. (Note: requires understanding of debits/credits.) (*Offered in online format.*)

ACC211 3 credits 3 periods

Financial Accounting

Introduction to theory and practice in the preparation and interpretation of general purpose financial statements. Prerequisites: None.

ACC212 3 credits 3 periods

Managerial Accounting

Development and analysis of accounting information for managerial planning and control. Prerequisites: A grade of C or better in (ACC111 and ACC112), or ACC211, and (CIS105 or permission of department/division).

ACC221 3 credits 3 periods

Tax Accounting

Preparation of and accounting procedures for individuals; introduction to partnerships and corporate tax structures. Prerequisites: ACC111 or ACC211 or permission of department/division. (*Offered only during the Fall semester.*)

ACC230 3 credits 3 periods

Uses of Accounting Information I

Introduction to the uses of accounting information for internal and external purposes with emphasis on financial statement analysis. Prerequisites: Grade of C or better in ACC111 or ACC211 or a grade of C or better in (ENG101 and MAT151 and CRE101), or equivalent, or satisfactory score on District placement exam.

ACC240 3 credits 3 periods

Uses of Accounting Information II

Introduction to the uses of accounting information for internal and external purposes with emphasis on analysis for use by management. Prerequisites: ACC230.

ADMINISTRATION OF JUSTICE STUDIES AJS

Applied Sciences Division Office AP 237B (480) 423-6599

AJS101 3 credits 3 periods

Introduction to Criminal Justice

An examination of the organization and jurisdiction of local, state and federal law enforcement, judicial and corrections systems; their history and philosophy; career opportunities and qualifying requirements, terminology and constitutional limitations of the system. Required in AJS curriculum. Prerequisites: None.

AJS109 3 credits 3 periods

Substantive Criminal Law

Covers philosophy of legal sanctions and historical development from the common law to modern American criminal law, classifications of crimes, elements of and parties to crimes, general definition of crimes, common defenses utilized. Includes specific offenses and the essential elements of each offense. Required in AJS curriculum. Prerequisites: None.

AJS112 3 credits 3 periods

Wellness for Law Enforcement Officers

The value of physical fitness in law enforcement and the basic elements of strength training, aerobic conditioning, flexibility, nutrition, and back injury prevention. Prerequisites: AJS101, AJS109, AJS212, AJS230, AJS260, AJS270 and AJS275.

AJS119 3 credits 4 periods

Computer Applications in Justice Studies

Provides literacy in microcomputer applications in major areas of the criminal justice system. Examines availability and uses of current software packages in criminal justice work. Provides hands-on experience with appropriate integrated software packages pertaining to justice studies. Prerequisites: None.

AJS123 3 credits 3 periods

Ethics and the Administration of Justice

Introduces and explores ethical issues and the justice system. Focuses on ethics and the law, the police, courts and corrections. Reviews ethical theory, concepts and practices as they relate to administration of justice. Encourages critical thinking and value decision making in criminal justice system situations. Prerequisites: None.

Course Descriptions

AJS155 2 credits 2 periods
Concealed Weapons Carry

Training in safe handling and use of handguns. Examines legal provisions related to carrying a concealed weapon; legal and moral implications of self-defense. Prerequisites: None. *(Pass/Fail grade only.)*

AJS157 2 credits 2 periods
Basic Handgun

Development of the basic knowledge and skills of handgun for self defense. Prerequisites: AJS155 or permission of instructor. *Course Note: Course meets requirements for a concealed carry weapons (CCW) permit renewal.*

AJS158AB 1 credit 1 period
Concealed Weapon Recertification

Legal provisions, safety precautions and restrictions covering the use of firearms and the firing of sidearms. Prerequisites: AJS151 or AJS155.

AJS161AA 1.5 credits 1.5 periods
Basic Track Evidence Collection

Covers methods used to locate, document, collect and preserve track evidence. Includes preparation to provide courtroom testimony. Prerequisites: None.

AJS162 3 credits 3 periods
Domestic Violence

Explores domestic violence as a social problem within the United States from historical, cultural, political, legal, and law enforcement perspectives. Provides an overview of theories, definitions and causes of, and interventions for domestic violence involving spousal, elder and child abuse along with teen dating violence. Examines the dynamics and effects of domestic violence. Addresses research issues and contemporary domestic violence policy. Prerequisites: None.

AJS190 3 credits 3 periods
Sex Crimes and Non-Conventional Sexual Behaviors

Examines evolving sexual mores and acts in the United States. Studies processes and procedures involved in labeling sex or sex-related acts as criminal and/or non-conventional. Explores impact of sex crimes on victims and responses by the criminal justice system. Prerequisites: None.

AJS192 3 credits 3 periods
Serial Killers and Mass Murderers

The study of serial killers, mass murderers and their victims. Examines the history and frequency of these crimes, profiles the killers and their victims, explores theories of causation, and discusses the problems and techniques of investigation, prosecution, punishment, and prevention. Prerequisites: None.

AJS195 3 credits 3 periods
International and Domestic Terrorism

An overview of the history, structure, goals, and activities of domestic and international terrorist groups. Explores theories explaining terrorism and reviews methods used to combat it. Prerequisites: None.

AJS200 3 credits 3 periods
Current Issues in Criminal Justice

Examines current issues, techniques and trends in the Criminal Justice System. Prerequisites: None.

AJS201 3 credits 3 periods
Rules of Evidence

A practical insight into the rules of evidence to include how to recognize evidence: the general rules governing admissibility of evidence; the hearsay rule and its exceptions; the use of documentary evidence, written memoranda, photographs and recordings; corpus delicti; opinion evidence, circumstantial evidence, evidential privileges. Required in AJS curriculum. Prerequisites: None.

AJS210 3 credits 3 periods
Constitutional Law

An examination of the U. S. Constitution as it relates to the law enforcement function. Includes statutory law and judicial decisions governing the areas of arrest, search and seizure, interrogations and confessions, self-incrimination and other constitutional guarantees. Required in AJS curriculum. Prerequisites: None.

AJS212 3 credits 3 periods
Juvenile Justice Procedures

Examines the history and development of juvenile justice theories, procedures, and institutions. Prerequisites: None.

AJS213 3 credits 3 periods
Evidence Technology/Fingerprints

Fingerprint identification, interpretation, and classification. The fundamentals of fingerprinting and the problems in developing latent prints, preservation of evidence and the chain of evidence. Prerequisites: None.

AJS214 3 credits 3 periods
Evidence Technology/Photography

The use of photography and other aids in identification and preservation of evidence such as fingerprints, footprints and impressions. Techniques in crime scene and traffic accident photography. Prerequisites: None.

AJS215 3 credits 3 periods
Criminalistics: Physical Evidence

The scientific analysis and examination of physical evidence with emphasis on scientific investigation, recognition, collection, and preservation of evidence. Topics include fingerprints, shoe prints, tool marks, firearms identification, paint chips and arson. Prerequisites: None.

AJS216 3 credits 3 periods
Criminalistics: Biological Evidence

The scientific analysis and examination of biological evidence with emphasis on collection and preservation of evidence. Topics discussed include blood, drugs, blood alcohol, hairs and fibers, and topics of special interest in criminalistics. Prerequisites: None.

AJS217 3 credits 3 periods
Court Procedures

Study of procedures practiced by courts of general and original jurisdiction. Extensive use of mock and moot trial methods used to prepare students in legal research, case preparation and presentation, and adversary hearings. Prerequisites: None.

Course Descriptions

AJS219 3 credits 3 periods

Crime Scene Technology: Physical Evidence

Scientific analysis and examination of physical evidence with emphasis on scientific investigation, recognition, collection, and preservation of evidence. Fingerprints, shoe prints, tool marks, firearms identification, paint chips and arson. Prerequisites: None.

AJS220 3 credits 3 periods

Organized Crime

Examines the history, structure and activities of organized crime groups. Reviews theories explaining the existence of organized crime and enforcement strategies used to combat it. Prerequisites: None.

AJS223 3 credits 3 periods

Forensic Pathology: Death Investigation (FOR223)

An examination of the medical investigation of sudden, unnatural, unexplained or violent deaths. Explains the legal and medical roles of death investigators and medical examiners. Additional topics include the autopsy, documenting and evaluating the body, routine and special investigative techniques, and death event reconstruction. Prerequisites: None.

AJS225 3 credits 3 periods

Criminology

Study of deviance, society's role in defining behavior; theories of criminality and the economic, social and psychological impact of crime; relationships between statistics and crime trends. Examines crime victimization and the various types of crime and categories of offenders. Required in the AJS curriculum. Prerequisites: None.

AJS230 3 credits 3 periods

The Police Function

Theories of procedures and methods of operations of public police with emphasis on discretionary powers available to the working police officer. Career opportunities and current trends in law enforcement presented. Prerequisites: None.

AJS232 3 credits 3 periods

The Judicial Process

Examines the nature of law and its evolution via the operation of the court systems of the United States. Primary emphasis on criminal courts and their role in the criminal justice system. Includes the study of state and federal courts and the law governing their respective jurisdictions. Incorporates analysis of the structures and processes within various jurisprudential frameworks. Special attention given to the processes of adjudication and the organizational behaviors within the court system and between the members of the courtroom workgroup. Prerequisites: None.

AJS240 3 credits 3 periods

The Correction Function

Examines the history and development of correctional theories and institutions. Prerequisites: None.

AJS242 3 credits 3 periods

Crime Scene Processing

Procedures and technology required to process crime scenes including how to protect a crime scene, collect information, search for, collect, and preserve physical and biological evidence, and conduct field tests. Practical experience in evidence collection and crime scene sketching and processing. Prerequisites: AJS213 and (AJS214 or AJS241) or permission of instructor.

AJS243 3 credits 3 periods

Crime Scene Reconstruction

Examines techniques used to reconstruct the physical actions that occurred at a crime or accident scene. Involves the use of physical, testimonial, and documentary evidence, knowledge of criminal modus operandi and the scientific method, including deductive and inductive logic. Includes analysis of case studies. Prerequisites: AJS215, or AJS216, or AJS219, or AJS275, or FOR105, or permission of instructor.

AJS244 3 credits 3 periods

Advanced Crime Scene Photography

Use of advanced photographic techniques for photographing crime scenes and forensic evidence. Includes flash photography, video, and special situation photography of latent prints, corpses, blood splatter and other forms of evidence. Prerequisites: AJS214, or AJS241, or permission of instructor.

AJS245 3 credits 3 periods

Forensic Pathology: Advanced Death Investigation (FOR245)

An advanced examination of the role of the medical examiner in crime scene investigations, mass disasters, motor vehicle accidents, and other unnatural deaths. Covers basic forensic biomechanics, advanced forensic anthropology and the role of the medical examiner as an expert court witness. Prerequisites: AJS223.

AJS255 3 credits 3 periods

Forensic Psychology

An interdisciplinary course that draws from the fields of psychology, sociology, criminology, and law. Focuses on various psychological constructs including psychiatric assessment and treatment and the nomenclature of mental disorders as well as legal constructs including the medicalization of deviance as embodied in dealing with the mentally ill criminal offender. Explores the interaction between psychology and law in the areas of civil commitment and various civil competencies. Examines legal and ethical issues that face the clinician and his/her patient in such arenas as confidentiality and privilege, the right to treatment, the right to refuse treatment, and the doctrine of informed consent. Prerequisites: PSY101.

AJS258 3 credits 3 periods

Victimology and Crisis Management

Focuses on victimology and techniques of crises intervention; and the importance of multicultural perspective. Includes coverage of sexual assault, family violence, child abuse, post-traumatic stress disorder, substance abuse, coping skills, stress management, and community resources. Prerequisites: None.

Course Descriptions

AJS260 3 credits 3 periods
Procedural Criminal Law
Concerned with the understanding of procedural criminal law. Examines the rationale underlying major court holdings, the procedural requirements that stem from these holdings, and their effect on the daily operations of the criminal justice system. Prerequisites: None.

AJS269AA/AB/AC 1-3 credits 5-15 periods
Internship
Supervised field training for preservice administration of justice students. Maximum of three (3) credit hours allowed in program. Prerequisites: Student sponsored by governmental enforcement agency and departmental approval.

AJS270 3 credits 3 periods
Community Relations
Examination, recognition and understanding of community problems; community action programs; methods of coping with human behavior, victimology, conflict and communication; ethnic and minority cultures and environments; the community and relationships with the criminal justice system. Prerequisites: None.

AJS275 3 credits 3 periods
Criminal Investigation I
Introduction to the theory of criminal investigation. Examines crime scene procedures, case preparation, interviewing, and basic investigative techniques. Prerequisites: None.

AJS282AA/AB/AC 1-3 credits 1-3 periods
**Volunteerism for Administration of Justice:
A Service Learning Experience**
Service learning field experience within private/public agencies and citizen volunteer groups. May be repeated for a total of six (6) AJS282 credit hours. Standard grading available according to procedures outlined in catalog. Prerequisites: Permission of instructor.

AJS290BN 1 credit 1 period
Courtroom Testimony Seminar
Courtroom demeanor and protocol. Role and primary functions of witness and legal counsels. Prerequisites: None.

ADVERTISING ARTS

See ART/ADVERTISING ART (ART/ADA), page 124.

AERONAUTICS

Applied Sciences Division Office AP 237B (480) 423-6599

AET101 5 credits 5 periods
Private Pilot Ground School, FAR Part 61
Federal Aviation Regulation (FAR) Part 61 ground school in preparation for the Federal Aviation Administration (FAA) Private Pilot Certificate written examination. Includes aerodynamics, airplane systems, airports, airspace, communications, federal aviation regulations, weather, navigation, airplane performance, flight planning and flight physiology. Prerequisites: None.

AET201 3 credits 3 periods
Instrument Rating Ground School, FAR Part 61
Federal Aviation Regulation (FAR) Part 61 ground school in preparation for the Federal Aviation Administration (FAA) instrument rating written examination. Includes instrument, navigation and engine indication systems; airspace; Federal Aviation Regulations applicable to instrument flight; weather, air traffic control procedures; and charts and approach plates. Flight planning, operations and physiology. Prerequisites: Completion of AET101 with a grade of C or better or FAA Private Pilot Certificate, or permission of instructor.

AEROSPACE STUDIES

AES

Applied Sciences Division Office AP 237B (480) 423-6599

Through an arrangement with Arizona State University at Tempe, Arizona, students at Scottsdale Community College can take freshman and sophomore year classes in ROTC. Students register for the classes at Scottsdale Community College and take the courses at Arizona State University. The goal of the ROTC classes is to provide a foundation of military knowledge and skills needed by junior officers in the military. Students may take ROTC credit in (Air Force) Aerospace Studies. For further information, contact Air Force ROTC or (480) 965-3181.

AES101 2 credits 2 periods
Air Force Today I
Introduction to U.S. Air Force and Air Force Reserve Officer Training Corps (AFROTC). Topics include: the Air Force mission and organization, customs and courtesies, officer opportunities, officership, and professionalism. Prerequisites: None.

AES103 2 credits 2 periods
Air Force Today II
Introduction to U.S. Air Force and Air Force Reserve Officer Training Corps (AFROTC). Topics include: the Air Force mission and organization, customs and courtesies, officer opportunities, officership, and professionalism. Prerequisites: AES101 or ASU Department of Aerospace Studies approval.

AES201 2 credits 2 periods
Evolution of USAF Air and Space Power I
Further preparation of AFROTC candidate. Topics include: Air Force heritage and leaders, communication skills, ethics, leadership, quality Air Force, and values. Prerequisites: AES103 or ASU Department of Aerospace Studies approval.

AES203 2 credits 2 periods
Evolution of USAF Air and Space Power II
Topics include: the Air Force mission and organization, customs and courtesies, officer opportunities, officership, and professionalism. Prerequisites: AES201 or ASU Department of Aerospace Studies approval.

Course Descriptions

AGRICULTURAL SCIENCE

Mathematics/Sciences Division PS 153 (480) 423-6111

ALSO SEE: Biology (BIO), page 129.

AGS187 3 credits 3 periods

Indoor Foliage Plants

Environmental and nutritional requirements for foliage plants used for interior decoration. Includes identification, nomenclature and uses. Prerequisites: None.

AMERICAN INDIAN STUDIES

American Indian Studies Office SB 118 (480) 423-6221
AIS Course Coordinator, Manuel F. Pino

American Indian Studies at Scottsdale Community College (SCC) offers an Associate in Transfer Partnership Degree (ATP) which requires a minimum of 60 semester credits for the program of study. The Maricopa Community College District Associate in Transfer Partnership Degree is designed to meet the needs of Maricopa Community College students transferring to public and private colleges and universities. The degree in American Indian Studies is developed specifically for students who have identified American Indian Studies as a major and have selected Arizona State University as the baccalaureate degree-granting institution to which they intend to transfer.

American Indian Studies at SCC is an interdisciplinary opportunity to develop a wider scope of understanding of American Indians, their traditions, struggles and aspirations for sovereignty and self-determination. Coursework offers students an opportunity to fulfill general education requirements consistent with the ATP degree and a series of classes concentrating on historic relations with non-Indian societies, the development of federal Indian law, tribal governments, treaty rights, environmental issues, public policy, economic development and contemporary social problems.

AIS101 3 credits 3 periods

Survey of American Indian Issues

Introduction to critical issues related to Native Americans. Examines political, economic, and social issues. Focuses on contemporary issues and factors influencing American Indian communities. Prerequisites: None.

AIS105 3 credits 3 periods

Introduction to American Indian Studies

Introduction to political, economic and social structures of American Indian Nations. Provides overview of American Indian tribal cultures prior to contact, the impact of European contact, and the influence of western social systems on tribal nations. Prerequisites: None.

AIS112 3 credits 3 periods

American Indian Policy (SOC112)

Reviews United States government policies and their impact on American Indian sovereignty. Examines historic, legal, economic and social issues regarding Indian policies and how they impact Indian Nations and individual Indians. Studies historical as well as contemporary policies created by the Federal Government that define the trust relationship between the United States government and Indian Nations. Prerequisites: None.

AGS

AIS113 3 credits 3 periods

Proposal Writing (MGT113)

Provides an overview of funding sources for grants. Reviews techniques and skills necessary to develop successful proposals. Focuses on the design and writing of a complete grant proposal related to a selected problem or issue. Prerequisites: None.

AIS140 3 credits 3 periods

American Indian History (HIS140)

Survey of American Indian history with emphasis on the last 200 years including developments in the 20th century. Focuses on selected groups such as the Cherokee, Iroquois Confederation, Navajo, Sioux and Indians of the Southwest in relation to cultural, economic, political and social continuity and changes. Topics include development and influence of federal policies, past and present issues confronting Native Americans and how Native American individuals and communities maintain their identities as they confront social changes. Prerequisites: None.

AIS141 3 credits 3 periods

Sovereign Indian Nations (SOC141)

Explores the sovereign status of American Indians as it relates to social relationships, traditions and culture of American Indians. Reviews historic relations with non-Indian societies, the development of federal Indian law, tribal governments and their functions. Examines treaty rights, environmental issues, public policy, economic development, other current issues, and contemporary social problems. Prerequisites: None.

AIS160 3 credits 3 periods

American Indian Law (SOC160)

Analyzes the legal system of the United States Government as it applies to American Indian Nations. Examines how United States legal institutions have impacted Indian sovereignty. Units of analysis include the development of Indian law, United States Supreme Court decisions, Congressional Acts, treaty rights and the development of tribal governments. Focuses on legal institutions that have abridged the property rights of Indian Nations. Prerequisites: None.

AIS201 1 credit 1 period

Tribal Management Seminar I (MGT201)

Discussion of the relationship between general management issues and their specific application to tribal government situations. Special consideration given to application of management theory and to the unique status and situation of tribal governments. Prerequisites: None.

AIS202 1 credit 1 period

Tribal Management Seminar II (MGT202)

Discussion of the relationship between general management issues and their specific application to tribal government situations. Special consideration given to application of management theory and to the unique status and situation of tribal governments. Prerequisites: MGT201 or permission of instructor.

AIS203 3 credits 3 periods

Fundamentals of Economic Development for Indigenous Nations (MGT203)

Provides a practical understanding of the economic development process. Examines ways in which development can be initiated and financed. Focuses on how budget systems can be used as management tools. Reviews fundamentals of proposal writing and budget management for grants. Prerequisites: ACC230 or permission of instructor.

Course Descriptions

AMERICAN SIGN LANGUAGE

See SIGN LANGUAGE (SLG), page 200.

ANTHROPOLOGY

Social/Behavioral Sciences Division SB 130 (480) 423-6206

ASB102 3 credits 3 periods
Introduction to Cultural and Social Anthropology

Principles of cultural and social anthropology, with illustrative materials from a variety of cultures. The nature of culture; social, political, and economic systems; religion, aesthetics and language. Prerequisites: None.

ASB222 3 credits 3 periods
Buried Cities and Lost Tribes: Old World

Introduction to archaeology through discoveries and the researchers who made them. Emphasis on methods of archaeological fieldwork and what these discoveries reveal about humanity, including the nature of archaeological inquiry, the development of human social groups, the changing role of religion in evolving societies, the origins of agriculture, the origins of settled lifeways, the rise of cities and complex societies, political strife across different cultures and the forces which tend to fragment societies. Examples drawn from Africa, Asia, Europe, the Pacific Islands, and Australia. Prerequisites: None.

ASB223 3 credits 3 periods
Buried Cities and Lost Tribes: New World

Introduction to archaeology through discoveries and the researchers who made them. Emphasis on methods of archaeological fieldwork and what these discoveries reveal about humanity, including the nature of archaeological inquiry, the development of human social groups, the changing role of religion in evolving societies, the origins of agriculture, the origins of settled lifeways, the rise of cities and complex societies, political strife across different cultures and the forces which fragment societies. Examples drawn from North American, Central America, and South America. Prerequisites: None.

ASB230 3 credits 3 periods
Principles of Archaeology

Introduction to archaeological methods and theory. Prerequisites: None.

ASB245 3 credits 3 periods
Indians of the Southwest

Comparative study of the cultures, including the histories and present status, of Indians of the Southwest. Prerequisites: None.

ASM104 4 credits 5 periods
Bones, Stones and Human Evolution

Study of human evolution and variation; including fossil hominids and their tools, primate anatomy and behavior, human genetics, and the environment and human biology. Prerequisites: None.

SLG ARCHITECTURAL TECHNOLOGY (Computer-Aided Drafting)

Applied Sciences Division Office AP 237B (480) 423-6599

ALSO SEE: Building Safety Technology (BLT), page 130
Civil Engineering Technology (CET), page 136
General Technology (GTC), page 168

NOTE: Effective Fall 2006, course prefixes, numbers, and titles for Architectural Technology/CAD have changed from the DFT prefix to ARC. Students currently enrolled in the program are urged to contact Myron Brower (480) 423-6229 or Michael Kuzmik (480) 423-6293 with questions or to set an appointment for advisement.

ARC121 3 credits 6 periods
Introduction to Architectural Drafting: Manual

Emphasis on basic techniques and principles of manual architectural drafting. Includes hand lettering, line work, dimensioning, multi-view projection, work in plan, section, and elevation views, design standards, wall details, office procedures, and portfolio development. Prerequisites: None.

ARC141 3 credits 6 periods
Architectural CAD I: Introduction

Introduction to Computer Aided Drafting (CAD) for Architecture, Interior Design, and related professions using AutoCAD software. Includes basic set-ups, architectural formats, two-dimensional drawing and editing commands, dimensions, text, and plotting typical to the industries. Prerequisites: None. ARC121 suggested but not required.

ARC142 3 credits 6 periods
Architectural CAD II: Plans and Elevations

Computer Aided Drafting (CAD) instruction directed to the creation of fully annotated plan, elevation, and schematic section views including dimensions, notes, symbols, and schedules. Introduction to three-dimensional (3D) AutoCAD Architectural Desktop. Prerequisites: ARC141, or equivalent, or department permission. ARC121 suggested but not required.

ARC146 3 credits 3 periods
Architectural Print Reading

Analysis and interpretation of architectural working drawings including written specifications and drawings prepared by consulting engineers. Prerequisites: None.

ARC243 3 credits 6 periods
**Architectural CAD III: Site Plans and Sections
(formerly DFT151)**

CAD-based (Computer-aided drafting) instruction directed to the creation of fully annotated site plans and sectional views. Development of professional quality site plans, wall sections, and building sections working from given residential and commercial layouts. Assignments incorporate applicable codes, construction materials and methods, and office practices typical to the local area. Prerequisites: ARC142 or permission of department. ARC121 suggested but not required.

Course Descriptions

ARC244 3 credits 6 periods
Architectural CAD III: Structural Systems
(formerly DFT200)

CAD-based (Computer-aided drafting) instruction for layout and completion of fully annotated structural drawings. Focuses on working from residential and commercial layouts to develop professional quality roof, roof framing, floor framing and foundation plans. Emphasis on the use of applicable codes, construction materials and methods, and office practices typical to the local area. Prerequisites: ARC142 or permission of department.

ARC245 3 credits 6 periods
Architectural CAD IV: Mechanical and Electrical Systems
(formerly DFT201)

CAD-based (Computer-aided drafting) instruction for layout and completion of fully annotated building systems drawings. Focuses on working from residential and commercial layouts to develop professional quality electrical, mechanical (HVAC), plumbing and reflected ceiling plans. Emphasis on the use of applicable codes, construction materials and methods, and office practices typical to the local area. Prerequisites: ARC142 or permission of department.

ARC246 3 credits 6 periods
Architectural CAD VI: Construction Details
(formerly DFT225)

Typical southwestern construction systems and details. Creation of personal standard detail files for wood frame, concrete masonry and other specialized construction systems. Prerequisites: (ARC243 and GTC124), or departmental approval.

ARC261 3 credits 6 periods
Architectural CAD 3D I: Introduction

Introduction to construction, manipulating, and rendering three-dimensional (3D) objects and architectural spaces on the computer using AutoCAD software. Prerequisites: ARC141 or equivalent, or permission of department. ARC142 suggested but not required.

ARC262 3 credits 6 periods
Architectural CAD 3D II: ADT and VIZ

Additional skill development in constructing, manipulating, and rendering three-dimensional (3D) architectural computer models using AutoCAD Architectural Desktop (ADT) and Viz Render (VIZ) software. Prerequisites: ARC261 or equivalent or permission of department.

ARC270 3 credits 6 periods
Architectural Technology Synthesis
(formerly DFT280)

Provides students an opportunity to integrate and synthesize knowledge and skills acquired in prerequisite courses. Using AutoCAD, students will complete a full set of working drawings under supervision comparable to workplace situations. Includes practice in self-checking work, correcting and editing drawings and assembling a portfolio. Prerequisites: (ARC243, ARC244, ARC245, GTC124 and BLT263) or permission of instructor. *Completed coursework will serve as a capstone assessment tool for the Architectural Technology Program and as a measure of student success in the program.*

ARC296 - COOPERATIVE EDUCATION: Information about ARC296 courses can be found on page 142.

ARC298 - SPECIAL PROJECTS: Information about ARC298 courses can be found on page 203.

ART/ADVERTISING ART ART/ADA

Art Department Office AB 112 (480) 423-6344
Fine Arts Division Office MB 139 (480) 423-6328

The Art Department offers a full range of courses designed to meet the needs of students who wish to pursue the transfer-oriented Associate in Arts degree or the more general Associate in General Studies degree. Students who plan to transfer to a four-year college or university are urged to become familiar with the specific requirements of the transfer institution. For those who pursue the Associate in General Studies degree, recommended areas of emphasis are computer graphics, drawing, graphic design, painting, photography, sculpture and watercolor. Departmental faculty members are available for assistance with course selection and guidance.

Most art courses require out-of-pocket expenses of \$25 to \$150.

ADA Advertising Arts

ADA109 3 credits 4 periods

Cartooning Methods

Production of cartoon drawing suitable for reproduction and submission to publishers. Introduction to greeting card design, editorial cartooning, comic strips and other uses of cartoons. Prerequisites: None.

ART Computer Arts

ART100 1 credit 2 periods

Introduction to Computer Graphic Art

Conceptualization, visualization and production of art using the computer. Prerequisites: None.

ART103 3 credit 4 periods

Typography in the Digital Age

Survey of the history of typography from its origins to the present including movements and individual designers. Emphasis on the function of typography and design and the role of typography as an integral part of effective visual communication. Study of type anatomy and the characteristics of specific families of type, principles of effective copy fitting, type color and contrast, and the relation of copy and image in graphic design. Prerequisites: None. Familiarity with the computer and with page geometry and/or illustration software recommended.

ART150 3 credits 6 periods

Digital Storytelling (COM/STO150)

Enables students to find and develop their personal stories. Emphasis on the use of digital technology to create, edit, produce and archive a digital story. Prerequisites: None. (ART150 is offered spring semester only.)

ART169 3 credits 6 periods

Two-Dimensional Computer Design (ADA169)

Generation of electronic two-dimensional images and traditional methods of visual problem solving. Understanding of computer techniques and art presentation methods. Prerequisites or Corequisites: ART100 or permission of instructor.

Course Descriptions

ART175 3 credits 6 periods
Electronic Publishing Design I (ADA175)
Introduction to the multiple elements of commercial publishing using the microcomputer. Basic foundation in the use of electronic page layout techniques. Emphasis on publication design layout and concepts. Prerequisites or Corequisites: ART100 or permission of instructor.

ART177 3 credits 6 periods
Computer-Photographic Imaging (ADA177)
Introduction to the multiple elements of microcomputer-photographic imaging. Basic foundation in the use of the photographic manipulation of images using software programs. Special attention to aesthetic foundations underlying photographic composition. Prerequisites or Corequisites: ART100 or permission of instructor.

ART181 3 credits 6 periods
Graphic Design I
Introduction to development of lettering and design skills through functional and aesthetic use of typography. Concentration on lettering for reproduction, type indication, historical development, type specification, and use of letter forms as design elements. Prerequisites: ART112 or permission of instructor.

ART182 3 credits 6 periods
Graphic Design II
Concept development and design solutions to problems in consumer advertising, sales promotion and public relations material. Interpreting art form and copy through creative graphic solutions. Pasteup and production processes. Prerequisites: ART181 or permission of instructor.

ART183 3 credits 6 periods
Computer Aided Graphic Arts I
Graphic design use in microcomputer, black and white graphics, standard and color brushes, lines, shapes, area fills and fonts. Application to illustration, advertising graphics, typography and video interaction. Prerequisites or Corequisites: ART100 or permission of instructor. (*ART183 offered only during first summer session.*)

ART184 3 credits 6 periods
Computer Animation (ADA/MMT184)
The art of animation (animated sequences, special effects, titles, etc.) using the computer. Construction characters, background graphics, color, scaling, storyboard, cells, timing, editing and surface rendering. Screening and discussion of selected animated short films and videos. Prerequisites: ART100, or ART111, or ART116, or permission of instructor.

ART190 3 credits 6 periods
Art of Web Site Design (MMT190)
Print vocabulary, relationships, and typographic style for HTML and World Wide Web publication. Discussion of color, proportion, and design emphasis. Producing Web sites using HyperText Markup Language (HTML), digital text, and graphics to produce artistic form and content for the Web. Prerequisites: ART180AB, or ART180AC, or ART180AE, or permission of instructor. (*ART190 not offered every semester.*)

ART199SB 1 credit 2 periods
Digital Storybook (COM/STO199SB)
Enables students to find and develop narratives representing their personal histories. Use of digital technology to produce a storybook and archive a digital story. Prerequisites: None. (*ART199SB is offered fall semester only.*)

ART270 3 credits 6 periods
Intermediate Computer Photographic Imaging
Intermediate microcomputer-based photographic imaging techniques. Refinement of aesthetic awareness and personal expression. Prerequisites: ART177 or (ART177AA and ART177AB).

ART274 3 credits 6 periods
Advanced Computer Photographic Imaging
Advanced microcomputer-based photographic imaging techniques. Advanced manipulation techniques of photographic images. Continued development of aesthetic awareness and personal expression. Prerequisites: ART270.

ART281 3 credits 6 periods
Graphic Design III
Advanced course in designing with letter forms and typestyles. Projects in creative use of lettering and type such as book covers, pamphlets, point of purchase, logo design and letterform used as shape for advertisement. Prerequisites: ART182 or permission of instructor.

ART282 3 credits 6 periods
Graphic Design IV
Continuation of skill development reached in ART181, ART182 and ART281 with emphasis on new product development and advertising; creating design program for industry or major event; and preparing professional portfolio. Prerequisites: ART281 or permission of instructor.

ART283 3 credits 6 periods
Computer Aided Graphic Arts II (ADA283)
Advanced skill development of graphic design through use of microcomputer. Emphasis on computer design and techniques for producing all types of camera-ready advertising art for printed matter and package design. Includes illustration, typography, photo imaging, and color separation. Prerequisites: ADA183, or ART183, or permission of instructor. (*ART283 offered only during first summer session.*)

ART289 3 credits 6 periods
Computer Illustration (ADA289)
Introduction to the multiple elements of commercial illustration using the microcomputer. Basic foundation in the use of computer techniques including color paint and draw programs for the production of commercial illustrations for publications and printed matter. Use of input and output devices. Prerequisites or Corequisites: ART100 or permission of instructor. (*ART289 offered Spring semester only.*)

Course Descriptions

ART291 3 credits 6 periods
Digital Prepress
Introduction to multiple elements of digital prepress concepts and techniques using the microcomputer. Basic foundation in the use of trapping and stripping software for the desktop. Use of electronic page layout techniques including color separations, registration, spot colors, impositions, signatures, and output production devices. Emphasis on prepress concepts. Prerequisites: ART100 or permission of instructor.

ART Photographic Arts

The photography curriculum is designed for students who desire to specialize in photography, either in a two-year preprofessional program or in a college transfer program. Students interested in a college transfer program are urged to consult the catalog of the college to which they will transfer.

Photography courses require additional out-of-pocket expenses of \$100 to \$150.

ART130 2 credits 2 periods
35MM Slide Techniques
Fundamentals of 35MM slide photography. Includes camera operations, exposure techniques, color slide materials and theory of color photography. Prerequisites: None.

ART131 3 credits 6 periods
Photography I
Basic black and white photographic principles and techniques. Camera functions and controls. Darkroom experience in film processing and printmaking. Camera required. Prerequisites: None.

ART132 3 credits 6 periods
Photography II
Advanced camera and darkroom techniques. Aesthetic awareness with personal expression. Prerequisites: ART131 or permission of instructor.

ART133 3 credits 6 periods
Photography III
Refinement of aesthetic and technical aspects producing convincing images of highest quality. Prerequisites: ART132 or permission of instructor. ART111 and ART116 recommended but not required.

ART134 3 credits 6 periods
Photography IV
Emphasis on personal statement and style. Related graphic art forms explored. Development of portfolio. Prerequisites: ART133 or permission of instructor.

ART137 3 credits 6 periods
Alternative Photographic Processes
Emphasis on development of alternative photographic processes including technique, aesthetics, and creative imagery. Exploration of various types of non-silver photographic processes including cyanotype, Van Dyke, Polaroid imaging, and others. Prerequisites: None.

ART138 3 credits 6 periods
Commercial Photography I
Basic techniques of lighting, camera work, and reproduction of commercial photography. Cooperation with commercial art community. Prerequisites: None. *(Prior completion of ART131 strongly recommended.)*

ART139 3 credits 6 periods
Commercial Photography II
Advanced techniques with portfolio organization and presentation. Prerequisites: ART138.

ART140 2 credits 4 periods
Portrait Photography
Insight into the profession of portrait photography. Application of the principles of design and fine art in lighting, composition, and posing. Prerequisites: ART131 or permission of instructor.

ART142 3 credits 6 periods
Introduction to Digital Photography
Fundamentals of digital photography. Includes camera operations, exposure techniques, introduction to digital output and theory of digital photography. Prerequisites: None.

ART234 3 credits 6 periods
Color Photography I
Basic principles of color theory, camera and darkroom techniques using positive materials. Prerequisites: ART131 or permission of instructor. *(ART234 is not offered every semester.)*

ART Visual Arts

ART105 1 credit 2 periods
Art Beyond the Classroom
Visual arts experience. Includes field trips to galleries, museums, and collections as well as art lectures, demonstrations, and varied studio experiences. May be repeated for a total of four credits. Prerequisites: None.

ART110 1 credit 2 periods
Experimental Chinese Painting
Explores ancient Chinese techniques with rice paper and Chinese ink to create traditional and nontraditional designs. Emphasis on use of Chinese techniques in mixed media works. Prerequisites: None.

ART111 3 credits 6 periods
Drawing I
Fundamental principles of drawing. Emphasis on composition and facility in objective and expressive representation, using variety of drawing media. Prerequisites: None.

ART112 3 credits 6 periods
Two-Dimensional Design (ADA112)
Study of fundamental elements and principles of two-dimensional design. Prerequisites: None.

Course Descriptions

ART113 Color	3 credits	6 periods
Investigation seeking visual solutions to a variety of problems concerning color in two and three dimensions and modes of color appearances, including light and effects in design and theory of design. Prerequisites: ART112.		
ART115 Three-Dimensional Design (ADA115)	3 credits	6 periods
Fundamental principles of three-dimensional design. Prerequisites: ART112.		
ART116 Life Drawing I	3 credits	6 periods
Use of form, structure and anatomy of draped and undraped human figure to develop basic principles of sound draftsmanship. Prerequisites: None.		
ART117 Life Drawing II	3 credits	6 periods
Further study of form, structure and anatomy of the draped and undraped human figure with emphasis on composition. Prerequisites: ART116.		
ART122 Drawing and Composition II	3 credits	6 periods
Emphasis on composition and exploration of drawing media. Prerequisites: ART111.		
ART151 Sculpture I	3 credits	6 periods
Exploration of sculptural form and expression in clay, plaster, stone, wood and metal. Prerequisites or Corequisites: ART115 or permission of instructor.		
ART152 Sculpture II	3 credits	6 periods
Emphasis on control of sculptural media. Prerequisites: ART151.		
ART165 Watercolor Painting I	3 credits	6 periods
Transparent and Gouache watercolor painting. Prerequisites: (ART111 and ART112), or permission of instructor.		
ART166 Watercolor Painting II	3 credits	6 periods
Painting in water soluble media. Emphasis on individual techniques and design. Prerequisites: ART165.		
ART167 Painting I	3 credits	6 periods
Exploration of technical and expressive possibilities of various painting media in easel painting. Prerequisites: (ART111 and ART112), or permission of instructor.		
ART168 Painting II	3 credits	6 periods
Continued refinement of painting skills and investigation of new possibilities in painting. Prerequisites: ART167 or permission of instructor.		

ART171 Jewelry I	3 credits	6 periods
Fundamentals of jewelry making. Covers hand formed methods, including cutting, shaping, forging, soldering, and lost wax technique. Prerequisites: None.		
ART172 Jewelry II	3 credits	6 periods
Further refinement of personal expression using techniques and design concepts of ART171. Prerequisites: ART171.		
ART211 Drawing and Composition III	3 credits	6 periods
Advanced development of drawing skill with emphasis on compositional theory. Prerequisites: ART122 or permission of instructor.		
ART216 Life Drawing III	3 credits	6 periods
Advanced creative study from model in various painting and drawing media. Prerequisites: ART117 or permission of instructor.		
ART217 Life Drawing IV	3 credits	6 periods
Further development of skills in expressive drawing materials and techniques as applied to finished drawings of the human form. Prerequisites: ART216 or permission of instructor.		
ART222 Drawing and Composition IV	3 credits	6 periods
Further study of drawing techniques with emphasis on individual problems and techniques. Prerequisites: ART211 or permission of instructor.		
ART251 Sculpture III	3 credits	6 periods
With emphasis on attention to individual problems and techniques. Prerequisites: ART152.		
ART252 Sculpture IV	3 credits	6 periods
Advanced sculpture problems and professional practices. Prerequisites: ART251.		
ART253 Woodcut	3 credits	6 periods
Focuses on relief method of printing, utilizing the techniques of Woodcut. Deals specifically with black and white images. Study of printing materials and tools, papers and printing methods. Relief printing in color introduced. Traditional forms of Woodcut, also an overview of innovative techniques in the field. Prerequisites: ART111 and ART113.		
ART255 Art Marketing	3 credits	3 periods
Career goals, presentation of artist and art work (portfolio, résumé, business cards, catalog), pricing and selling works, networking, establishing a studio, promotion and publicity, writing press releases, proposal writing, business ethics, artist rights, copyright law, contracts and agreements, royalties, record keeping and communication skills. Prerequisites: None. (ART255 not offered every semester.)		

Course Descriptions

ART265 3 credits 6 periods
Watercolor Painting III
Continuation of watercolor painting with emphasis on control and expression. Prerequisites: ART166.

ART266 3 credits 6 periods
Watercolor Painting IV
Advanced problems directed toward more personal expression. Prerequisites: ART265.

ART267 3 credits 6 periods
Painting III
Development of materials and techniques of painting. Individual problem-solving. Prerequisites: ART168 or permission of instructor.

ART268 3 credits 6 periods
Painting IV
Advanced problems in painting. Study with greater emphasis on personal expression. Prerequisites: ART267 or permission of instructor.

ART275 3 credits 6 periods
Lost Wax Casting I
Introduction to lost wax casting techniques for jewelry and small sculptures. Emphasis on design concepts as related to three-dimensional forms. Prerequisites: None.

ART290 3 credits 6 periods
Studio Art
Studio course for art majors allowing continuation in a subject field. Prerequisites: All 100- and 200-level courses in subject matter area, or permission of instructor.

ART295AA-JC 1-3 credits 2-6 periods
Art Workshop/Seminar
Advanced-level workshop/seminar in art disciplines. Prerequisites: Minimum of three (3) credits introductory and three (3) credits intermediate-level courses in specific field or permission of department/division chair.

ART HUMANITIES

ARH

Art Department Office AB 112 (480) 423-6344
Fine Arts Division Office MB 139 (480) 423-6328

ARH100 3 credits 3 periods
Introduction to Art
Understanding and enjoyment of art through study of painting, sculpture, architecture design, photography, and decorative arts. Emphasis on contemporary topics and cultural diversity in the arts. Prerequisites: None.

ARH101 3 credits 3 periods
Prehistoric Through Gothic Art
History of art from prehistoric through medieval period. Prerequisites: None.

ARH102 3 credits 3 periods
Renaissance Through Contemporary Art
History of art from around the world from the Renaissance through contemporary period. Prerequisites: None.

ARH110 3 credits 3 periods
History of Graphic Design
Survey of the history of graphic design from its origins to the present. Traces the characteristics, aesthetics and the reciprocal influence of design and society. Includes movements and individual designers. Emphasizes the function of design as a distinct but equal branch of human visual communication and the role of design as the dominant visual exercise of the contemporary world. Prerequisites: None.

ARH112 3 credits 3 periods
History of Modern Art
Development and significant aspects of modern art, including comparisons of relationships in expressionism, abstractions, fantasy, and art since mid-century. Prerequisites: None.

ARH115 3 credits 3 periods
History of Photography
Survey of history of photography from beginning to present. Emphasizes medium's impact upon society and other visual arts. Technical developments, aesthetic concerns, and individual photographers studied. Prerequisites: None.

ARH118 3 credits 3 periods
Introduction to Chinese Art
Explores Chinese philosophy, symbolism, history and religions that underlie the choice of subject matter and life forms in Chinese art. Uses Chinese bamboo brush, ink and rice paper to study Chinese calligraphy and traditional subjects for painting. Prerequisites: None.

ARH145 3 credits 3 periods
History of American Indian Art
Survey of American Indian Art from pre-contact to present. Reviews the impact of these art forms on contemporary American society, other world societies and on the visual arts. Explores characteristics, cultural influences and concerns represented in various art forms past and present. Features field trips to galleries and collections. Prerequisites: None.

ASTRONOMY

AST

Mathematics/Sciences Division PS 153 (480) 423-6111

The astronomy courses satisfy the natural sciences requirement for the Associate in Arts degree and most four-year curricula. When taken together, AST101 and AST102 satisfy ASU's general science requirement (SG). AST111 and AST112 fulfill ASU's natural sciences requirement (SG, SQ) when they are taken with AST113 and AST114, respectively.

AST101 3 credits 3 periods
Survey of Astronomy
Survey of astronomy for the nontechnical student. The history, content and evolution of the solar system and the universe in general. Astronomical principles and instrumentation. The planets, moons, sun, comets, stars and star formation, galaxies and cosmology. Prerequisites: None.

Course Descriptions

AST102 1 credit 3 periods

Survey of Astronomy Laboratory

Astronomical observations and exercises designed to familiarize students with the sky, telescopes, and methods used in astronomy. Prerequisites: None. May accompany AST101.

NOTE: AST111 and AST112 are each a first course in astronomy. Either course can be taken alone or both can be taken in either order.

AST111 3 credits 3 periods

Introduction to Astronomy I

Introduction to astronomy for the non-science major. History of astronomy, properties of light, instruments, the solar system and nearby stars. Prerequisites: MAT092 or equivalent.

AST112 3 credits 3 periods

Introduction to Astronomy II

Introduction to astronomy for the non-science major. Structure and evolution of stars; star clusters; galaxies; cosmology. Prerequisites: MAT092 or equivalent.

AST113 1 credit 3 periods

Astronomy I Laboratory

Astronomical observations and exercises to supplement AST111. Prerequisites or Corequisites: AST111.

AST114 1 credit 3 periods

Astronomy II Laboratory

Astronomical observations and exercises to supplement AST112. Prerequisites or Corequisites: AST112.

BIOLOGY

BIO

Mathematics/Sciences Division PS 153 (480) 423-6111

ALSO SEE: Agricultural Science (AGS), page 122, and Pre-Professional Programs, page 198.

The biology curriculum is designed to satisfy the requirements for the first two years of most four-year curricula leading to the preparation of a student to enter such career fields as marine biology, wildlife biology, biological research, biology teacher or other professional biological science careers. The curriculum assumes the student has had a strong science and mathematics background in high school, including one or two years of biology, a year of chemistry, a year of physics and three years of mathematics. Students who have not had this kind of background should consult a science advisor to select courses that should be taken to strengthen their science and mathematics background before pursuing the biology curriculum. Recommended courses to be taken in sequence are BIO181 and BIO182. Supporting courses include CHM151, CHM152 or CHM154, CHM230 or (CHM235 and CHM236), PHY111, PHY112, MAT150 or MAT151, MAT182 and MAT212. Consultation with the catalog of the college to which you plan to transfer may recommend a more rigorous math sequence as follows: MAT150 or MAT151, MAT182, MAT220, MAT230 and MAT240. In addition to the general education courses required for the Associate in Arts degree, BIO109, BIO205, BIO241 and BIO280 are suggested electives.

Since there is some variation in specific courses required by various universities and colleges, students should consult the catalog of the school to which they will transfer and select courses accordingly. Students who take BIO181 and BIO182 should plan to take both of these courses at SCC to ensure that no course information is missing. Students registering for any of the following courses should be aware that many of these courses require field trip activities at students' expense.

BIO100 4 credits 6 periods

Biology Concepts

A one-semester introductory course covering basic principles and concepts of biology. Methods of scientific inquiry and behavior of matter and energy in biological systems are explored. Field trips may be required at students' expense. Prerequisites: None.

BIO105 4 credits 6 periods

Environmental Biology

Fundamentals of ecology and their relevance to human impact on natural ecosystems. Field trips may be required at students' expense. Prerequisites: None.

BIO108 4 credits 6 periods

Plants and Society

A global study of plants in relation to humans; as a source of food, fiber, drugs, and other products; for aesthetic value, survival, and energy. Prerequisites: None.

BIO109 4 credits 6 periods

Natural History of the Southwest

Study of the common plants and animals of the Southwest including their distribution, adaptation, behavior, and ecology. Introduction to basic field and laboratory techniques used in the study of natural history. Specific field problems presented dealing with plant and animal analysis and ecological interrelationships. Prerequisites: None. *Course Note: Field trips may be required at students' expense.*

BIO145 4 credits 6 periods

Marine Biology

A survey of marine environments and their biotic communities with emphasis on the natural history of marine organisms. Prerequisites: None.

BIO149 1-4 credits 7-28 days

Field Biology

Field expeditions designed to study natural history of selected geographical locations. Field observations of behavior, distribution and adaptations of organisms within natural communities emphasized. May be repeated for up to four hours elective credit. Prerequisites: None.

BIO156 4 credits 6 periods

Introductory Biology for Allied Health

An introductory biology course for allied health majors with an emphasis on humans. Topics include fundamental concepts of cell biology, histology, microbiology, and genetics. Prerequisites: None. One year of high school chemistry or one semester of college-level chemistry recommended.

Course Descriptions

BIO160 4 credits 6 periods
Introduction to Human Anatomy and Physiology
 Principles of scientific method. Structural organization, homeostasis and control mechanisms of the body. Specific chemistry concepts. Structure and function of the major systems of the body. Prerequisites: None.

BIO181 4 credits 6 periods
General Biology (Majors) I
 Principles of structure and function of living things at molecular, cellular and organismic levels of organization. Field trips may be required at students' expense. Prerequisites: None. One year of high school chemistry or one semester of college-level chemistry is strongly recommended.

BIO182 4 credits 6 periods
General Biology (Majors) II
 Additional principles of structure and function of living things at molecular, cellular, and organismic and higher levels of organization. Field trips may be required at students' expense. Prerequisites: A grade of C or better in BIO181.

BIO201 4 credits 6 periods
Human Anatomy and Physiology I
 Study of structure and function of the human body. Topics include cells, tissues, integumentary system, skeletal system, muscular system, and nervous system. Prerequisites: (BIO156 or BIO181 with a grade of C or better) or (one year high school biology course with a grade of C or better). (CHM130 or higher numbered CHM prefixed course) or (one year of high school chemistry) suggested but not required.

BIO202 4 credits 6 periods
Human Anatomy and Physiology II
 Continuation of structure and function of the human body. Topics include endocrine, circulatory, lymphatic, respiratory, digestive, urinary, and reproductive systems; and fluid and electrolyte balance. Prerequisites: A grade of C or better in BIO201.

BIO205 4 credits 6 periods
Microbiology
 Study of microorganisms and their relationship to health, ecology, and related fields. Prerequisites: (BIO156 or BIO181 with a grade of C or better) or (one year high school biology with a grade of C or better). (CHM130 or higher numbered CHM prefixed course) or (one year of high school chemistry) suggested but not required.

BUILDING SAFETY TECHNOLOGY BLT

Applied Sciences Division OfficeAP 237B (480) 423-6599

ALSO SEE: Architectural Technology (ARC), page 123
 Civil Engineering Technology (CET), page 136
 General Technology (GTC), page 168

BLT120 3 credits 3 periods
Techniques of Building Inspection
 Theory and practice of zoning, foundation, structural, mechanical and electrical inspection in modern residential and commercial construction. Prerequisites: None.

BLT121 3 credits 3 periods
Electrical Codes
 Principles of safe electrical installations and proper inspection procedures. Topics include conduit installation, transformer service, raceways, control circuits, grounding and bonding; hazardous occupancies and the National Electrical Code. Prerequisites: None.

BLT124 3 credits 3 periods
Designing for the Americans with Disabilities Act (ADA)
 In-depth analysis of federal standards described in the Americans with Disabilities Act (ADA). Reviews the state of Arizona's enforcement document (AzDAAG). Focuses on helping designers, architects, and building officials create barrier-free buildings and facilities. Prerequisites: None.

BLT127 3 credits 3 periods
Plumbing Codes
 Code requirements and construction practices. Topics include underground and above-ground plumbing, venting and finish plumbing. Prerequisites: None.

BLT128 3 credits 3 periods
Mechanical Codes
 Code requirements and construction practices. Topics include duct work, conductors and fuel supply, insulation, and controls. Prerequisites: None.

BLT140 3 credits 3 periods
Environmentally Responsible Building
 An overview of environmentally responsible building and a historical survey of building methodologies. Introduces design concepts and strategies related to the mitigation of environmental impacts. Examines building processes, environmental issues and the interdependent nature of our built environment. Topics include human impacts, climate and geography, sustainability, renewable energies, water use and energy, resource efficiency, building materials, indoor air quality and waste reduction. Prerequisites: None.

BLT263AK 3 credits 3 periods
Building Codes: IBC
 Designed specifically to acquaint students with safety principles of building construction under the International Building Code (IBC), including structural requirements for wood, masonry and concrete, fire resistance of building construction, fire resistant materials, and ratings and occupancy requirements. Prerequisites: None.

Course Descriptions

BLT263AL 3 credits 3 periods

Building Codes: IRC

Designed specifically to acquaint students with safety principles of building construction under the International Residential Code (IRC), including structural requirements for wood, masonry and concrete, fire resistance of building construction, fire resistant materials, and ratings and occupancy requirements. Prerequisites: None.

BUSINESS (Fastrack)

SCC Business Institute
14350 N. 87th Street, Scottsdale (480) 425-6910
www.sccbi.com

For course descriptions in the Business (Fastrack) Program, see:

- ACC110 – page 118
- GBS120 and 200 – below
- IBS201 – page 177
- MGT109, 126, 127, 179 and 206 – page 178
- MKT210 – page 180

BUSINESS GBS and SBU

Business Division Office AP 237A (480) 423-6253

GBS Business

GBS120 3 credits 3 periods

Workplace Communication Skills (Fastrack)

Reviews planning, organization, development, and evaluation of written and oral communication in business settings, including informative and persuasive messages. Prerequisites: None. *(Offered in both on-campus and online formats.)*

GBS131 3 credits 3 periods

Business Calculations

Review of basic arithmetic and application of mathematics to business problems, includes percentage, interest, discount, and markups. Prerequisites: None.

GBS151 3 credits 3 periods

Introduction to Business

Characteristics and activities of current local, national, and international business. An overview of economics, marketing, management and finance. Prerequisites: None.

GBS200 3 credits 3 periods

Understanding the Business Environment (Fastrack)

Provides an overview of the major external factors and issues affecting the contemporary business environment. Prerequisites: None. *(Offered in both on-campus and online formats.)*

GBS205 3 credits 3 periods

Legal, Ethical, and Regulatory Issues in Business

Legal theories, ethical issues and regulatory climate affecting business policies and decisions. Prerequisites: None. *(Offered in both on-campus and online formats.)*

GBS220 3 credits 3 periods

Quantitative Methods in Business

Business applications of quantitative optimization methods in operations management decisions. Prerequisites: (Grade of C or better in MAT150, MAT151 or MAT152) or equivalent, or satisfactory score on district placement exam. NOTE: For business majors only, course can be substituted for Finite Math, MAT172.

GBS221 3 credits 3 periods

Business Statistics

Business applications of descriptive and inferential statistics, measurement of relationships, and statistical process management. Prerequisites: Grade of C or better in GBS220 or MAT172.

GBS233 3 credits 3 periods

Business Communication

Internal and external business communications, including verbal and nonverbal techniques. Prerequisites: ENG101 or ENG107 with grade of C or better, or permission of department/division. *(Offered in both on-campus and online formats.)*

GBS261 3 credits 3 periods

Investments II

Evaluation of various investment forms including study of inflation, taxation, government securities, stocks and bonds, real estate and retirement plans. Prerequisites: None.

GBS262 3 credits 3 periods

Investments I

Value-oriented approach to security analysis. Focuses primarily on specific skills for analyzing stocks and bonds traded on the organized exchanges. Includes portfolio management as it applied to stocks and bonds and an introduction to options and their applications. Prerequisites: GBS261 or approval of the instructor.

SBU Society and Business

SBU200 3 credits 3 periods

Society and Business

The study and scientific inquiry of issues and demands placed on business enterprise by owners, customers, government, employees and society. Included are social, ethical and public issues and analysis of the social impact of business responses. Prerequisites: None.

Course Descriptions

BUSINESS-PERSONAL COMPUTERS

BPC

CIS Department Office CM 404 (480) 423-6588

ALSO SEE: Cisco Networking Technology (CNT), page 136
 Computer Information Systems (CIS), page 137
 Microsoft Networking Technology (MST), page 183
 Office Automation Systems (OAS), page 194

BPC100 2 credits 2 periods

Business-Personal Computers

Introduction to the use of personal computers in the business environment. Computer hardware components, operating system functions and concepts. Procedures for running and using business application software to produce documents and spreadsheets. Prerequisites: None. *(Offered in online format.)*

BPC101AA 1 credit 2 periods

Introduction to Computers I

Computer software applications for the personal computer, including electronic spreadsheet and word processing, keyboarding review, and a desktop environment. Prerequisites: None. *(Offered in online format.)*

BPC101BA 1 credit 1 period

Introduction to Computers II

Computer software applications for the personal computer, including database management, computer graphics, electronic spreadsheet, and word processing, and operating system commands. Prerequisites: BPC101AA. *(Offered in online format.)*

BPC101CA 1 credit 1 period

Introduction to Computers III

Individualized advanced applications of software selected to solve specific problems on the personal computer. Prerequisites: BPC101BA or permission of instructor.

BPC110 3 credits 4 periods

Computer Usage and Applications

Introduction to business and personal computer operations and usage. Software applications for analyzing and solving business problems including word processing, spreadsheet, database, and presentation graphics. Prerequisites: None. *(Offered in both online and instructor-led formats.)*

BPC111AA 1 credit 1.7 periods

Computer Keyboarding I (OAS111AA)

Mastery of essential microcomputer keyboarding skills. Emphasis on touch typing of alphabetic and numeric keys and symbols. Prerequisites: None. *(Offered in both online and instructor-led formats.)*

BPC111AB 1 credit 1.7 periods

Computer Keyboarding II (OAS111AB)

Further development of microcomputer keyboard speed and accuracy. Emphasis on touch typing with speed and accuracy development of numerals as related to preparation and handling of documents. Prerequisites: BPC/OAS111AA or permission of instructor. *(Offered in online format.)*

BPC114AE 1 credit 2 periods

Excel: Level I (CIS114AE)

Computer spreadsheet skills for solving business problems using Excel, including calculations, forecasting and projections. Prerequisites: None. *(Offered in online format.)*

BPC114BE 1 credit 2 periods

Excel: Level II (CIS114BE)

Additional Excel spreadsheet techniques, including macro programming, database searching, extraction, and linking to obtain prescribed reports and graphs. Prerequisites: BPC/CIS114AE or permission of instructor. *(Offered in online format.)*

BPC117AM 1 credit 2 periods

Database Management: Microsoft Access - Level I (CIS117AM)

Introduction to the basic elements of a current version of the Microsoft Access database management program for casual and beginning users. Prerequisites: None. *(Offered in online format.)*

BPC117BM 1 credit 2 periods

Database Management: Microsoft Access - Level II (CIS117BM)

Exploration of additional components of the Microsoft Access database management program. Prerequisites: BPC117AM or CIS117AM or permission of instructor. *(Offered in online format.)*

BPC117CM 1 credit 1 period

Database Management: Microsoft Access - Level III (CIS117CM)

Application of the features of the Microsoft Access program to some common database management problems. Prerequisites: BPC117BM or CIS117BM. *(Offered in online format.)*

BPC117DM 3 credits 5 periods

Microsoft Access: Database Management (CIS117DM)

Introduction to the basic elements, exploration of additional components and common database management problems related to the Microsoft Access program. Prerequisites: None. *Course Note: Combines the contents of BPC/CIS117AM and BPC/CIS117BM and BPC/CIS117CM.*

BPC118AB 1 credit 2 periods

PowerPoint: Level I (CIS118AB)

Use of PowerPoint software to produce professional-quality presentation visuals. Prerequisites: None. *(Offered in online format.)*

BPC118BB 1 credit 2 periods

PowerPoint: Level II (CIS118BB)

Use of PowerPoint software add movement and sound to desktop presentations to enhance audience attention. Prerequisites: BPC/CIS118AB. *(Offered in online format.)*

BPC121AB 1 credit 2 periods

Microsoft Command Line Operations (CIS121AB)

Use of the Microsoft command line within windows: basic concepts, internal and external commands, subdirectories, and editor. Prerequisites: None. *(Offered in online format.)*

Course Descriptions

BPC121AE 1 credit 2 periods

Windows Operating System: Level I (CIS121AE)

Specific topics include booting and shutting down the computer, navigating the desktop, start button features, task bar status, and receiving online help/support. Exploring and managing folders and files, running programs, and learning about Wordpad and Paint application programs. Prerequisites: None. *(Offered in online format.)*

BPC133AA 1 credit 2 periods

Internet/Web Development Level I - A (CIS133AA)

Overview of the Internet and its resources. Hands-on experience with various Internet communication tools. Prerequisites: None. *(Offered in online format.)*

BPC133BA 1 credit 1 period

Internet/Web Development Level I - B (CIS133BA)

Exploration of additional Internet resources. Hands-on experience with a variety of resource discovery and information retrieval tools as well as enhancement of Web pages. Prerequisites: BPC/CIS133AA. *(Offered in online format.)*

BPC133CA 1 credit 1 period

Internet/Web Development Level I - C (CIS133CA)

Web site development using enhancement codes. Includes frames, style sheets and javascript as well as design principles and typography. Prerequisites: BPC/CIS133BA. *(Offered in online format.)*

BPC135DK 2 credits 2 periods

Word: Level I (OAS135DK)

Using Word word processing software to create and name files, edit text, format, and print a variety of documents. Prerequisites: The ability to use a keyboard at a minimum of 24 wpm or permission of instructor. *(Offered in both online and instructor-led formats.)*

BPC170 3 credits 4 periods

Computer Maintenance I: A+ Prep

Technical aspects of the microcomputer, including system setup (hardware and software) and basic troubleshooting. Emphasis on basic troubleshooting, use of tools, hardware components and hardware/software interfacing. Prerequisites: CIS105 and BPC121AB or permission of instructor.

BPC210 3 credits 4 periods

Advanced Computer Usage and Applications

Advanced application of software for business and personal computers including word processing, spreadsheet, database, and presentation. Includes integration of applications, and Internet. Prerequisites: BPC110 or permission of instructor.

BPC217AM 3 credits 4 periods

Advanced Microsoft Access: Database Management (CIS217AM)

Advanced database concepts including database design, primary and secondary key selection and relationships between tables. Queries, subforms, macros, events, Visual Basic modules and Access Internet features also covered. Prerequisites: (BPC/CIS117DM or BPC/CIS117CM).

BPC235DK 2 credits 2 periods

Word: Level II (OAS235DK)

Using Word word processing software features such as math, columns, macros, styles, graphics, sort, outlines, and table of contents. Prerequisites: BPC/OAS135DK or permission of instructor. *(Offered in online format.)*

BPC270 3 credits 4 periods

Microcomputer Maintenance II

Advanced technical aspects of maintaining and servicing microcomputers. Emphasis placed on installation, periodic maintenance, diagnosis, and/or problem resolution of power system, motherboard, memory, storage devices, and network interface cards. Extensive use of software diagnostic and utility tools. Prerequisites: BPC170 with grade of C or better, or permission of instructor.

BPC273 3 credits 4 periods

Advanced Server computer Maintenance: Server + Prep

Focuses on complex technical aspects of the microcomputer server, including hardware installation, configuration, and troubleshooting. Strong emphasis on network operating systems installation, data storage subsystems, and data recovery. Preparation for the CompTIA Server+ examination. Prerequisites: (BPC170 and MST140), or permission of instructor.

CHEMISTRY

CHM

Mathematics/Sciences Division PS 153 (480) 423-6111

The chemistry curriculum recommended for students who plan to become majors in chemistry, biology, pre-medical, pre-dental or pre-pharmacy is CHM150/151, 154, 235 and 236. Students with insufficient chemistry background should enroll in CHM130. Other chemistry courses currently required at one or more of the state universities are:

Nursing	CHM130
Home Economics	CHM130
Textiles	CHM130
Engineering	CHM150/151, CHM152

CHM107 3 credits 3 periods

Chemistry and Society

A survey of chemistry and its impact on the environment. Completion of CHM107LL is required to meet the Natural Science requirement. Prerequisites: None.

CHM107LL 1 credit 3 periods

Chemistry and Society Laboratory

Laboratory experience in support of CHM107. Prerequisites or Corequisites: CHM107.

CHM130 3 credits 3 periods

Fundamental Chemistry

Elements of general chemistry for all students. Course content designed to meet the needs of students in such areas as agriculture, home economics, nursing, and physical education among others. Serves to prepare the student for CHM151 or CHM230. Prerequisites: Grade of C or better in CHM090, or MAT091, or MAT092, or MAT102, or satisfactory score on math placement exam.

Course Descriptions

CHM130LL 1 credit 3 periods
Fundamental Chemistry Laboratory
Laboratory experience in support of CHM130. Prerequisites or Corequisites: CHM130.

CHM150 4 credits 4 periods
General Chemistry I
A detailed study of the principles of chemistry. *Completion of CHM151LL required to meet the Natural Science requirement.* Prerequisites: (CHM130 and CHM130LL) or (one year of high school chemistry with a grade of C or better taken within the last five years), and completion of intermediate algebra or equivalent. *Course Note: Designed for science majors and students in preprofessional curricula. Students may receive credit for only one of the following: CHM150 or CHM151.*

CHM151 3 credits 3 periods
General Chemistry I
A detailed study of the principles of chemistry. *Completion of CHM151LL required to meet the Natural Science requirement.* Prerequisites: (CHM130 and CHM130LL) or (one year of high school chemistry with a grade of C or better taken within the last five years), and completion of intermediate algebra or equivalent. *Course Note: Designed for science majors and students in preprofessional curricula. Students may receive credit for only one of the following: CHM150 or CHM151.*

CHM151LL 1 credit 3 periods
General Chemistry I Laboratory
Laboratory experience in support of CHM151. Prerequisites: CHM130LL or equivalent. Prerequisites or Corequisites: CHM151.

CHM152 3 credits 3 periods
General Chemistry II
A study of the chemical properties of the major groups of elements, equilibrium theory, thermodynamics, electrochemistry, and other selected topics. Completion of CHM152LL is required to meet the Natural Science requirement. Prerequisites: CHM151 and CHM151LL.

CHM152LL 1 credit 3 periods
General Chemistry II Laboratory
Laboratory experience in support of CHM152. Prerequisites: CHM151LL or equivalent. Prerequisites or Corequisites: CHM152 or equivalent.

CHM154 3 credits 3 periods
General Chemistry II with Qualitative Analysis
A study of the chemical properties of the major groups of elements, equilibrium theory, thermodynamics, kinetics, electrochemistry and other selected topics. Includes qualitative analysis. Prepares students for all sophomore chemistry courses. Completion of CHM154LL required to meet the Natural Science requirement. Prerequisites: CHM151 and CHM151LL.

CHM154LL 2 credits 6 periods
General Chemistry II with Qualitative Laboratory
Laboratory experience in support of CHM154. Includes qualitative analysis. Prerequisites: CHM151LL or equivalent. Prerequisites or Corequisites: CHM154.

CHM230 3 credits 3 periods
Fundamental Organic Chemistry
Chemistry of representative groups of organic compounds, emphasizing biological applications. Course content designed to meet the needs of students in agriculture, home economics, nursing, pre-physician assistant, and physical education among others. Prerequisites: (CHM130 and CHM130LL) or (CHM151 and CHM151LL).

CHM230LL 1 credit 3 periods
Fundamental Organic Chemistry Laboratory
Laboratory experience in support of CHM230. Prerequisites: CHM130LL, or CHM151LL, or equivalent. Prerequisites or Corequisites: CHM230.

CHM235 3 credits 3 periods
General Organic Chemistry I
Rigorous introduction to chemistry of carbon-containing compounds. Reaction mechanisms and recent methods of synthesis emphasized. Prerequisites: CHM152 and CHM152LL, or CHM154 and CHM154LL.

CHM235LL 1 credit 4 periods
General Organic Chemistry I Laboratory
Laboratory experience in support of CHM235. Prerequisites: CHM152LL, or CHM154LL, or equivalent. Prerequisites or Corequisites: CHM235.

CHM236 3 credits 3 periods
General Organic Chemistry IIA
Study of chemistry of carbon-containing compounds continued. Structural determination and additional reaction mechanisms and modern methods of synthesis emphasized. Prerequisites: CHM235 and CHM235LL.

CHM236LL 1 credit 4 periods
General Organic Chemistry IIA Laboratory
Laboratory experience in support of CHM236. Prerequisites: CHM235LL or equivalent. Prerequisites or Corequisites: CHM236.

CHILD/FAMILY STUDIES

CFS

Social/Behavioral Sciences Division SB 130 (480) 423-6206

ALSO SEE: Early Childhood Development (ECH), page 150
Early Education (EED), page 151
Family and Consumer Science (FCS), page 165
Infant/Toddler Development (ITD), page 175

CFS120 1 credit 1 period
Contemporary Issues in Early Childhood (ECH120)
Designed to develop understanding of a broad range of contemporary issues that impact the child in today's society. Course directed at pre-service and in-service professionals. May be repeated for credit. Prerequisites: None.

CFS181 3 credits 3 periods
Enhancing Infant and Toddler Development
Principles of development in children from birth through 30 months. Emphasis on individuality of child and the adult role in providing a safe and stimulating environment for the development of the child. Prerequisites: None.

Course Descriptions

CFS190 **3 credits** **4 periods**
Home-Based Visitation
Emphasis on development of skills needed to successfully complete home-based client visitation. Opportunities for field-based observations provided. Prerequisites: None.

CFS210 **3 credits** **3 periods**
Family Life Education
Provides an overview of the professional work within the field of family life education. Emphasis on developing flexible, culturally sensitive and effective professional skills. Prerequisites: None.

CFS220 **3 credits** **3 periods**
Introduction to Parenting and Family Development
Overview of the field of family and parent development. Focuses on parenthood as a developmental process and cultural influences on child rearing. A family systems perspective introduced and applied to understanding families with children. Prerequisites: None.

CFS225 **3 credits** **3 periods**
Foundations of Parent Education
Professional development as related to work with parents. Emphasis on developing effective skills with parents, professionals and paraprofessionals involved with the child. Skills and techniques to facilitate and strengthen the individual and family relationships. Prerequisites: None.

CFS240 **3 credits** **3 periods**
Human Behavior in Context
Considers the influences of physical and social environments in which human behavior occurs. Includes multiple roles and perspectives of the individual, the family, society and the professional. Prerequisites: None.

CFS250 **3 credits** **3 periods**
Social Policy and Families
Examines the impact of social policy on family systems and the implications for professional roles and practice. Prerequisites: None.

CFS258 **3 credits** **3 periods**
Families in Society
Areas of concentration include family transition, diversity in structure and culture faced by contemporary families, problems, crisis and change affecting the stress on families as our society progresses into a more complicated future. The study of change as an integral part of all family's day-to-day experiences while recognizing that family ancestral and cultural dimensions are fundamental for all family groupings. Course designed for those seeking careers in Family Studies, Parent Education, Psychology, Social Work/Human Services. Prerequisites: CFS157 and CFS259, or permission of Instructor.

CFS259 **3 credits** **3 periods**
Sexuality over the Life Span
Examination of the physical, psychological, social, and cultural contributions to human sexuality. Emphasis on family life and cultural variation. Examination of facts and myths, current literature, and changing mores regarding human sexuality. Sexuality of males and females in contemporary society; impact of sexual trends on society; home/school issues in sexuality education. Prerequisites: Permission of department. Student must be 18 years or older.

CHINESE LANGUAGE **CHI**
Language/Communication Division LC 305 (480) 423-6459

CHI101 **5 credits** **6 periods**
Elementary Chinese (Mandarin) I
Introduction to the basic grammar, pronunciation, and vocabulary of the Mandarin Chinese language. Includes the study of Chinese culture, practice of listening, speaking, reading and writing skills. Prerequisites: None.

CHI102 **5 credits** **6 periods**
Elementary Chinese (Mandarin) II
Continued study of grammar and vocabulary along with the study of Chinese culture. Emphasis on pronunciation and speaking skills. Prerequisites: CHI101 or equivalent.

CHI115 **3 credits** **3 periods**
Beginning Chinese Conversation I
Introduction to Chinese sound system, basic grammar, and vocabulary necessary to develop speaking ability in Mandarin Chinese. Designed for students seeking speaking and listening ability with little emphasis on writing and reading Chinese characters. Prerequisites: None.

CHI116 **3 credits** **3 periods**
Beginning Chinese Conversation II
Continued development of speaking and listening skills for effective communication in Mandarin Chinese. Includes elements of Chinese culture. Prerequisites: CHI115 or equivalent.

CHI201 **5 credits** **6 periods**
Intermediate Chinese I
Continued development of speaking, reading, and writing proficiency in Mandarin Chinese through building vocabulary, phrases, idioms, and grammatical patterns. Includes study of Chinese culture. Prerequisites: CHI102 or equivalent or permission of instructor.

CHI202 **5 credits** **6 periods**
Intermediate Chinese II
Advanced development of speaking, reading, and writing skills in Mandarin Chinese, and continued exploration of Chinese culture. Prerequisites: CHI201 or equivalent or permission of instructor.

Course Descriptions

CISCO NETWORK TECHNOLOGY

CNT

CIS Department Office CM 404 (480) 423-6588

ALSO SEE: Business-Personal Computers (BPC), page 132
Computer Information Systems (CIS), page 137
Microsoft Networking Technology (MST), page 183
Office Automation Systems (OAS), page 194

CNT140 4 credits 6 periods

Cisco Networking Basics

Introduction to the computer networking field. Covers network terminology and protocols, local area networks (LAN), and wide area networks (WAN). Includes Open Systems Interconnection (OSI) models, cabling and cabling tools, routers, router programming, Ethernet, Internet Protocol (IP) addressing, and network standards. Preparation for the Cisco Certified Network Associate examination. Prerequisites: None.

CNT150 4 credits 6 periods

Cisco Networking Router Technologies

Knowledge of skills to install, configure, customize, maintain and troubleshoot Cisco routers and components. Preparation for Cisco certification examination. Prerequisites: CNT140 or permission of instructor.

CIVIL ENGINEERING TECHNOLOGY

CET

Applied Sciences Division Office AP 237B (480) 423-6599

ALSO SEE: Architectural Technology (ARC), page 123
Building Safety Technology (BLT), page 130
General Technology (GTC), page 168

CET104 3 credits 3 periods

Community Planning and Development

Provides a comprehensive overview of the urban planning and development process. Introduces planning theories, methodologies, and strategies with practical applications from local and other urban communities. Topics include municipal planning, land use and zoning, circulation, water and waste water management, storm drainage and public utility services. Examines the economic development process, environmental and legal issues and focuses on the interdependent nature of development. Prerequisites: None.

COMMUNICATION

COM

Communication Arts Dept. Office PA 133A (480) 423-6076
Fine Arts Division Office MB 139 (480) 423-6328

Speech communication classes include both theory and practice in a variety of communication situations (group, interpersonal, public) and settings (cultural, organizational, performance). Many college programs require specific communication courses. To assure they meet the unique communication requirements of their major, students should check with an advisor before selecting a communication course.

COM100 3 credits 3 periods

Introduction to Human Communication

Theory and practice of communication skills in public, small group, and interpersonal settings. Includes study of the speech communication process. Prerequisites: None.

COM110 3 credits 3 periods

Interpersonal Communication

Theory and practice of communication skills which affect day-to-day interactions with other persons. Topics may include using verbal and nonverbal symbols, interactive listening, resolving interpersonal conflict, developing and maintaining personal and professional relationships. Prerequisites: None.

COM125 3 credits 3 periods

Presentational Speaking

Techniques for developing oral presentations which include visual media. Principles of verbal message development and related visual design stressed. Techniques of managing the presentational environment including question and answer periods and the operation of common equipment. Prerequisites: None. (*COM125 not offered every semester.*)

COM150 3 credits 6 periods

Digital Storytelling (ART/STO150)

Enables students to find and develop their personal stories. Emphasis on the use of digital technology to create, edit, produce and archive a digital story. Prerequisites: None. (*COM150 is only offered spring semester.*)

COM199SB 1 credit 2 periods

Digital Storybook (ART/STO199SB)

Enables students to find and develop narratives representing their personal histories. Use of digital technology to produce a storybook and archive a digital story. Prerequisites: None. (*COM199SB is offered fall semester only.*)

COM207 3 credits 3 periods

Introduction to Communication Inquiry

Recommended for the communication major. Overview of theory and methodological practice in communication with particular attention to scholarly writing skills. Emphasis on development of critical thinking skills through active participation in the research process. Prerequisites: ENG101 or ENG107 or equivalent, and COM100 or equivalent or permission of instructor.

COM215 3 credits 3 periods

Listening

Emphasis on diagnosis of individual listening, corrective procedures, and reinforcement of improved habits through normal and speeded listening drills. Includes everyday communication experiences. Prerequisites: None.

COM220 3 credits 3 periods

Student Leadership

Leadership strategies, skills, and practice for student leaders. Focus on leadership styles, relational and task communication skills, conducting meetings, problem solving/conflict resolution techniques, and managing change. Specific application to projects in public relations, services, advocacy, and clubs. Prerequisites: Participation in Student Leadership Forum or permission of instructor.

Course Descriptions

COM222 3 credits 3 periods
Argumentation
 Discussion and practice of the use of evidence, applied reasoning, recognition of fallacies, selection of arguments, and methods of analyzing issues. Prerequisites: ENG101, or ENG107, or equivalent.

COM225 3 credits 3 periods
Public Speaking
 Designed to enhance student's ability to present public speeches confidently and competently. Also designed to improve information literacy and critical thinking skills. Prerequisites: ENG101, or ENG107, or equivalent.

COM230 3 credits 3 periods
Small Group Communication
 Principles and processes of small groups and development of skills for participation and leadership in small group settings. Practice in problem solving, decision making, and information sharing. Prerequisites: ENG101, or ENG107, or equivalent.

COM241 3 credits 3 periods
Performance of Literature (THP241)
 The study, analysis, and preparation of prose, poetry, and dramatic literature. Preparation of material for public audiences. Prerequisites: ENG101, or ENG107, or equivalent.

COM250 3 credits 3 periods
Introduction to Organizational Communication
 Introduction to the study of communication in organizations including identification of variables, roles and patterns influencing communication in organizations. Prerequisites: None.

COM251 3 credits 3 periods
Interviewing
 Principles and techniques of interviewing, including practice through real and simulated interviews in informational, persuasive, and employee-related situations. Prerequisites: None. (*COM251 not offered every semester.*)

COM259 3 credits 3 periods
Communication in Business and Professions
 Interpersonal, group, and public communication in business and professional organizations. Emphasis on oral communication. Prerequisites: ENG101, or ENG107, or equivalent.

COM263 3 credits 3 periods
Elements of Intercultural Communication
 Basic concepts, principles, and skills for improving oral communication between persons from different minority, racial, ethnic, and cultural backgrounds. Prerequisites: None.

COM271 3 credits 3 periods
Voice and Diction (THP271)
 Exercises and techniques to free the voice and improve projection, resonance, and articulation. Covers international phonetic alphabet and standard stage speech. Prerequisites: None.

COM281 1 credit 3 periods
Communication Activities
 Designed to provide students with competence and confidence in a variety of speech situations beyond the classroom setting. May include presentations to service organizations and/or competition at other colleges and universities. Prerequisites: None. (*COM281 not offered every semester.*)

COM298 - SPECIAL PROJECTS: Information about COM298 courses can be found on page 203.

COMPUTER INFORMATION SYSTEMS CIS

CIS Department Office CM 404 (480) 423-6588

ALSO SEE: Business Personal Computers (BPC), page 132
 Cisco Network Technology (CNT), page 136
 Microsoft Networking Technology (MST), page 183

CIS102 1 credit 1 period
Interpersonal and Customer Service Skills for IT Professionals
 Examines behaviors necessary to develop and support an effective client service organization. Focuses on methods of increasing the effectiveness of help-desk professionals when responding to a range of customer conditions. Prerequisites: None.

CIS105 3 credits 4 periods
Survey of Computer Information Systems
 Overview of computer technology, concepts, terminology, and the role of computers in society. Discussion of social and ethical issues related to computers. Use of word processing, spreadsheet, database, and presentation software. Includes programming and use of the Internet. Exploration of relevant emerging technologies. Prerequisites: None.

CIS114AE 1 credit 2 periods
Excel: Level I (BPC114AE)
 Computer spreadsheet skills for solving business problems using Excel, including calculations, forecasting, and projections. Prerequisites: None.

CIS114BE 1 credit 2 periods
Excel: Level II (BPC114BE)
 Additional Excel spreadsheet techniques, including macro programming, database searching, extraction, and linking to obtain prescribed reports and graphs. Prerequisites: BPC/CIS114AE or permission of instructor.

CIS117DM 3 credits 5 periods
Microsoft Access: Database Management (BPC117DM)
 Introduction to the basic elements, exploration of additional components and common database management problems related to the Microsoft Access program. Prerequisites: None. *Course Note: Combines the contents of BPC/CIS117AM and BPC/CIS117BM and BPC/CIS117CM.*

CIS118AB 1 credit 2 periods
PowerPoint: Level I (BPC118AB)
 Use of PowerPoint software to produce professional-quality presentation visuals. Prerequisites: None.

Course Descriptions

CIS119DL 3 credits 4 periods
Oracle: Database Management
Introduction to the basic elements, exploration of additional components and common database management problems related to the Oracle program. Combines the contents of CIS119AL, CIS119BL and CIS119CL. Prerequisites: None.

CIS119DO 3 credits 4 periods
Introduction to Oracle: SQL
Use of Oracle tools and methodologies to fulfill real-world business information requirements. Hands-on exercises for designing and creating database structures to store, retrieve, update, and display data in a relational database using the SQL programming language. Creating and maintaining database objects. Advanced retrieval techniques. Prerequisites: CIS105 or permission of instructor.

CIS119DP 3 credits 4 periods
Oracle: Database Administration
Basic administrative tasks performed by a database administrator (DBA). Conceptual understanding and hands-on applications of the Oracle database architecture and interaction of its components. Prerequisites: (CIS119DO and CIS164AB), or CIS126++, or permission of instructor.

CIS120AF 1 credit 2 periods
Computer Graphics: Adobe Photoshop - Level I (BPC120AF)
Provides students with the capability to use Adobe Photoshop graphics software on a computer. Basic foundation course in the use of electronic techniques to select, manipulate, and edit images for graphics design, and image correction. Prerequisites: None. (*Offered in online format.*)

CIS120DC 3 credits 4 periods
Computer Graphics: Macromedia Flash (BPC120DC)
Provides students with the ability to use Macromedia Flash graphics software on microcomputers. Covers basic animation techniques used in the creation, manipulation, and editing of Flash animation graphics. Prerequisites: None.

CIS120DF 3 credits 4 periods
Computer Graphics: Adobe Photoshop (BPC120DF)
Provides students with the capability to use Adobe Photoshop graphics software on a computer. Basic foundation course in the use of electronic techniques to select, manipulate, and edit images, work with masks, channels and layers; combine raster and vector graphics; print in color, manage color, and create graphics for the web. Prerequisites: None.

CIS121AB 1 credit 2 periods
Microsoft Command Line Operations (BPC121AB)
Use of the Microsoft command line within windows: basic concepts, internal and external commands, subdirectories, and editor. Prerequisites: None.

CIS121AE 1 credit 2 periods
Windows Operating System: Level I (BPC121AE)
Specific topics include booting and shutting down the computer, navigating the desktop, start button features, taskbar status, and receiving on-line help support. Exploring and managing folders and files, running programs, and learning about Wordpad and Paint application programs. Prerequisites: None.

CIS126DA 3 credits 4 periods
UNIX Operating System
Use of a UNIX operating system including system components, built-in commands, files, and directories, editors, and UNIX shell and command lines. Installation, configuration, and maintenance of a UNIX operating system. Create scripts and batch files, and maintain system communications. Prerequisites: None.

CIS131AA 1 credit 1 period
Doing Business on the Internet
Overview of different ways businesses are taking advantage of and using the Internet. Includes how companies are selling items and services over the Internet, techniques used to expand customer contacts, marketing strategies, availability of government and financial information, future potential and disadvantages, using the Internet for customer service, establishing a World Wide Web site. Some previous computer experience preferred. Prerequisites: None.

CIS133DA 3 credits 4 periods
Internet/Web Development Level I (BPC133DA)
Overview of the Internet/WWW and its resources. Hands-on experience with various Internet/WWW communication, resource discovery and information retrieval tools. Web page development also included. Prerequisites: None.

CIS150 3 credits 4 periods
Programming Fundamentals
Structured program design and logic tools. Use of computer problems to demonstrate and teach concepts using appropriate programming language. Prerequisites: CIS105, or permission of instructor.

CIS158 3 credits 4 periods
COBOL Programming I
Programming in structured COBOL for preparation of business reports. Hands-on computer experience. Prerequisites: CIS105, or permission of instructor.

CIS159 3 credits 4 periods
Visual Basic Programming I
Use of the Visual Basic programming language to solve problems using suitable examples from business or other disciplines. Prerequisites: CIS105, or permission of instructor.

CIS162 3 credits 4 periods
C Programming I
Beginning C programming. Includes features needed to construct programs, functions, pointers, input and output options, data types, structures and unions, and disk file operations. Prerequisites: CIS105, or permission of instructor.

CIS162AB 3 credits 4 periods
C++: Level I
Introduction to C++ programming including general concepts, program design, development, data types, operators, expressions, flow control, functions, classes, input and output operations, debugging, structured programming, and object-oriented programming. Prerequisites: CIS105, or permission of instructor.

Course Descriptions

CIS162AC **3 credits** **4 periods**
Visual C++: Level I
Beginning C programming. Includes features needed to construct programs, functions, pointers, input and output options, data types, structures and unions, and disk file operations. Prerequisites: CIS105, or permission of instructor.

CIS162AD **3 credits** **4 periods**
C#: Level I
Introduction to C# programming. Including general concepts, program design, development, data types, operators, expressions, flow control, functions, classes, input and output operations, debugging, structured programming, and object-oriented programming. Prerequisites: CIS105, or permission of instructor.

CIS163AA **3 credits** **4 periods**
Java Programming: Level I
Introduction to Java programming. Includes features needed to construct Java Applets, Java Applications, control structures, methods, arrays, character and string manipulation, graphics, and object-oriented programming. Prerequisites: CIS105.

CIS164AB **3 credits** **4 periods**
Oracle: PL/SQL Programming
Writing PL/SQL procedures, functions, and packages. Creating and managing PL/SQL program units and database triggers in Oracle development environment. Managing dependencies and manipulating large objects. Prerequisites: CIS119DO, or permission of instructor.

CIS164AC **3 credits** **4 periods**
Oracle: Developer Forms I
Building and testing interactive applications consisting of one or more Developer forms modules. Building a complete forms application using Oracle Developer. Customizing forms with graphical user input items, such as check boxes, list items and radio groups. Modifying data access by creating event-related triggers. Prerequisites: CIS164AB, or permission of instructor.

CIS164AG **2 credits** **3 periods**
Oracle: Data Modeling and Relational Database Design
Top-down, systematic approach to developing a relational database and defining requirements as entities, attributes, and relationships. Developing an entity-relationship (ER) diagram that accurately reflects the business. Mapping the ER diagram to an initial database design. Prerequisites: CIS105 or permission of instructor.

CIS166 **3 credits** **4 periods**
Web Scripting/Programming
Software development for Web sites, including client-side script and Common Gateway Interface (CGI) scripting. Covers Web-based transaction processing and use of databases in conjunction with the Web. Includes security issues. Prerequisites: (CIS133CA or CIS133DA) or permission of instructor.

CIS167AA **3 credits** **4 periods**
C++ Object-Oriented Programming
Key object-oriented programming concepts in C++; hands-on experience developing C++ programs. Includes language constructs and extensions. Prerequisites: CIS162AA or permission of instructor.

CIS169 **3 credits** **4 periods**
Introduction to Visual Basic for Applications
Introduction to Visual Basic for Applications (VBA) using Microsoft Office environments. Includes Dynamic Data structures, VBA class modules and error trapping and handling. Creation of customized office applications and network shares as well as multimedia techniques also covered. Prerequisites: CIS159 or permission of instructor.

CIS175SA **3 credits** **4 periods**
Interconnecting Cisco Network Devices (CCT260)
Procedures for interconnecting existing computer networks. Emphasis on internetworking, layer usage, and software configuration. Covers router and switch usage, protocol suite and wide-area networking, as well as Internet protocol address and routing configuration. Also includes frame relay and X.25 configuration, access list traffic management, and alternate router access information. Prerequisites: None.

CIS190 **3 credits** **4 periods**
Introduction to Local Area Networks
Overview of local area networks. Emphasis on the elements of a local area network, current issues and products, and use of a local area network. Includes terminology, hardware and software components, connectivity, resource monitoring and sharing, electronic mail and messaging, and security issues. Prerequisites: CIS105, or permission of instructor.

CIS191 **3 credits** **4 periods**
Novell NetWare System Administration
Knowledge and skills required to administer or manage a Novell NetWare local area network operating system. Level I, II, and III network management tasks. Prerequisites: CIS105, or permission of instructor.

CIS217AM **3 credits** **4 periods**
Advanced Microsoft Access: Database Management (BPC217AM)
Advanced database concepts including database design, primary and secondary key selection and relationships between tables. Queries, subforms, macros, events, Visual Basic modules and Access Internet features also covered. Prerequisites: (BPC/CIS117DM or BPC/CIS117CM).

CIS219DO **1 credit** **2 periods**
Oracle: Extended Data Retrieval with SQL
Retrieve data using advanced techniques such as set operators and hierarchical retrieval. Focuses on writing SQL and SQL *Plus script files. Prerequisites: CIS119DP or permission of instructor.

CIS220DC **3 credits** **4 periods**
Advanced Web Programming with Macromedia Flash
Advanced Flash programming, action scripting, tweening, advanced buttons and user input, movie clips, using dynamic sound and text, managing information flow, Object-Oriented Programming concepts in relation to Flash. Prerequisites: CIS120DC or permission of instructor.

CIS224 **3 credits** **4 periods**
Project Management Microsoft Project for Windows (BPC224)
Introduction to project management concepts while working with MS Project to solve complex project management networks, including creating Gantt and PERT charts, tracking project progress, planning for restrictions, and integrating MS Project with other software packages such as Excel, Word, PowerPoint and cc Mail. Prerequisites: None.

Course Descriptions

CIS225 3 credits 3 periods
Business Systems Analysis and Design
Investigation, analysis, design, implementation and evaluation of business computer systems. Prerequisites: Any programming language or permission of instructor.

CIS225AB 3 credits 3 periods
Object-Oriented Analysis and Design
Methodologies and notations for fundamental object-oriented analysis and design including use cases, objects, classes, stereotypes, and relationships. Object-oriented iterative process for system development. A continuous application development exercise for applying the analysis and design concepts. Prerequisites: Any program language, or permission of instructor.

CIS226AA 3 credits 4 periods
Internet/Intranet Server Administration: UNIX
Set up and management of internet/intranet services, including World Wide Web (WWW) and Simple Mail Transfer Protocol (SMTP) in a UNIX environment. Includes coverage of security issues. Prerequisites: (CIS126DA and CIS133DA) or permission of instructor.

CIS226AB 3 credits 4 periods
Internet/Intranet Server Administration: Windows
Set up and management of internet/intranet services, including World Wide Web (WWW) and Simple Mail Transfer Protocol (SMTP) in a Windows server environment. Includes coverage of security issues. Prerequisites: CIS133DA and CIS191DL or permission of instructor.

CIS226AC 3 credits 4 periods
Internet/Intranet Server Administration: Novell NetWare
Set up and management of internet/intranet services, including World Wide Web (WWW) and Simple Mail Transfer Protocol (SMTP) in a Novell NetWare server environment. Includes coverage of security issues. Prerequisites: CIS133DA or permission of instructor.

CIS226AD 3 credits 4 periods
Internet/Intranet Server Administration: IntranetWare
Set up and management of internet/intranet services, including World Wide Web (WWW) and Simple Mail Transfer Protocol (SMTP) in an IntranetWare server environment. Includes coverage of security issues. Prerequisites: CIS133DA or permission of instructor.

CIS233AA 1 credit 2 periods
Internet/Web Development Level II - A
Design and creation of pages on the World Wide Web using hypertext markup language (HTML). Hands-on experience authoring HTML and preparing sophisticated web documents. Prerequisites: BPC/CIS133BA or permission of instructor.

CIS233AB 1 credit 2 periods
Internet Web Publishing FrontPage Level I
Introduction to designing and creating pages on the Internet's World Wide Web using FrontPage. Hands-on experience authoring hypertext markup language (HTML) and preparing beginning web documents. Prerequisites: BPC/CIS133BA or permission of instructor.

CIS233AC 1 credit 2 periods
Internet Web Publishing: Dreamweaver: Level I
Introduction to designing and creating pages on the Internet's World Wide Web using Dreamweaver. Hands-on experience authoring hypertext markup language (HTML) and preparing beginning web documents. Prerequisites: BPC/CIS133BA or permission of instructor.

CIS233BA 1 credit 1 period
Internet/Web Development Level II - B
Hands-on experience designing Web presentations using advanced markup languages, programming languages, scripts, and multimedia. Prerequisites: CIS233AA or permission of instructor.

CIS233DA 3 credits 4 periods
Internet/Web Development Level II
Design and create pages on the World Wide Web with a variety of markup languages, programming languages, scripts, and multimedia. Hands-on experience authoring and preparing sophisticated web documents. Exploration of best practices/issues for web design and publishing and careers in web development and e-commerce. Prerequisites: BPC/CIS133CA or BPC/CIS133DA or permission of instructor.

CIS234 3 credits 4 periods
XML Application Development
The use of Extensible Markup Language (XML) to make documents smarter, simplify Web automation, and to communicate between databases, both within and between corporations. Includes techniques for XML generation, data extraction and sharing, and transformation and managing of XML files. Prerequisites: (CIS133CA or CIS133DA) and (CIS117DM or CIS119DO), or permission of the instructor.

CIS235 3 credits 4 periods
e-Commerce
Introduction to Electronic Commerce on the Internet. Designing an electronic storefront including web page content and development, e-commerce site marketing, advertisement, legal and security considerations, credit card and other debit transaction covered. Also includes current issues in e-commerce. Prerequisites: CIS133CA, or CIS133DA, or permission of instructor.

CIS240 3 credits 3 periods
Local Area Network Planning and Design
Analysis of the needs and requirements for a local area network (LAN). Emphasis on basic systems analysis and design for a local area network, selection of appropriate hardware and software components. Includes current and future issues, needs analysis, cost estimation, selection of connectivity and network components, and issues relating to access, security, and support. Prerequisites: CIS190, or MST140, or permission of instructor.

CIS245 3 credits 4 periods
Novell NetWare Advanced System Administration
NetWare network management and monitoring skills. Topics related to server and client management and network performance. Prerequisites: CIS191.

Course Descriptions

CIS250 3 credits 3 periods
Management Information Systems

Business organization, control, and communication; database concepts; systems design; and computer systems. Prerequisites: CIS225.

CIS258 3 credits 4 periods
COBOL Programming II

Advanced COBOL concepts and file maintenance techniques. Hands-on computer experience. Prerequisites: CIS158.

CIS259 3 credits 4 periods
Visual Basic Programming II

Use of the Visual Basic programming language to identify and solve advanced problems using suitable examples from business or other disciplines. Prerequisites: CIS159 or permission of instructor.

CIS262 3 credits 4 periods
C Programming II

Advanced-level C programming. Programming with emphasis on data management, dynamic allocation, varied memory models, interfacing with the operating system, efficiency, and advanced debugging techniques. Prerequisites: CIS162, or permission of instructor.

CIS262AC 3 credits 4 periods
Visual C++ : Level II

Advanced-level C programming. Programming with emphasis on data management, dynamic allocation, varied memory models, interfacing with the operating system, efficiency, and advanced debugging techniques. Prerequisites: CIS162AC, or permission of instructor.

CIS263AA 3 credits 4 periods
Java Programming: Level II

Intermediate Java programming. Includes features needed to construct object-oriented programming, multithreading, multimedia, files, streams and data structure. Prerequisites: CIS163AA or permission of the instructor.

CIS266 4 credits 5 periods
Network Service and Support

Troubleshooting, servicing and supporting computer networks. Hands-on experience in supporting, expanding, servicing, diagnosing and troubleshooting networked computers of multiple architectures and configurations. Use of diagnostic equipment, common troubleshooting procedures and documentation necessary to maintain networks. Prerequisites: (CIS191, or CIS191DB, or CIS191DC, or CIS191DD) and CIS242, or permission of instructor.

CIS268 3 credits 4 periods
Microsoft Visual InterDev for Web Developers

Provides students the skills necessary to take full advantage of Visual InterDev to develop Web sites that support their organization's business goals. Prerequisites: CIS233DA, or permission of the instructor.

CIS270 3 credits 4 periods
Essentials of Network and Information Security

Threats to security of information systems, responsibilities and basic tools for information security, including communication security, infrastructure security, organizational security and basic cryptography. Introduction to the language of network security and hardware, software and firmware components of an information security system for local, metropolitan, enterprise, and wide area networks. Helps prepare participants for the CompTia Security+ exam and the GLAC Security Essentials Certificate (GSEC). Prerequisites: CNT150, or (MST150 or MST150 any module), or permission of instructor.

CIS277AA 3 credits 4 periods
Windows CE Programming for Visual Basic

Extensive hands-on experience developing Windows CE applications using the Microsoft Windows CE Toolkit for Visual Basic. Testing and debugging in both the emulator and Windows CE environments. Prerequisites: CIS259, or permission of instructor.

CIS277AB 3 credits 4 periods
Windows CE Programming for Visual C++

Extensive hands-on experience developing Windows CE applications using MFCs and the Win32 API. Testing and debugging in both the emulator and Windows CE environments. Prerequisites: CIS163AB, or permission of instructor.

CIS277AC 3 credits 4 periods
Windows CE Programming for Java

Extensive hands-on experience developing Windows CE applications using Visual J++ and the Microsoft SDK for Java. Testing and debugging in both the emulator and Windows CE environments. Prerequisites: (CIS163AA or CIS163AB) or permission of instructor.

CIS280 3 credits 4 periods
Current Topics in Computing

Critical inquiry of current topics in computing. Application of industry trends to solve problems and/or investigate issues. Prerequisites: None.

CIS280AA-AB 1-2 credits 2-3 periods
Current Topics in Computing

Critical inquiry of current topics in computing. Application of industry trends to solve problems and/or investigate issues. Prerequisites: None.

CIS290AA-AC 1-3 credits 6-18 periods
Computer Information Systems Internship (BPC290AA-AC)

Work experience in business or industry. Prerequisites: Permission of instructor.

CIS296 - COOPERATIVE EDUCATION: Information about CIS296 courses can be found on page 142.

Course Descriptions

COMPUTER SCIENCE

Mathematics/Sciences Division PS 153 (480) 423-6111
CSC Course Coordinator, Gerald Thurman ... CM 424 (480) 423-6110

CSC100AA 3 credits 4 periods

Introduction to Computer Science for Non-Computers Majors

Concepts of problem solving, structured programming in C++, fundamental algorithms and techniques, and computer system concepts. Social and ethical responsibilities. Intended for majors other than Computer Science. Prerequisites: MAT120, or MAT121, or MAT122.

CSC110AA 3 credits 4 periods

Introduction to Computer Science for Majors

Concepts of problem solving, structured and object-oriented programming in Java, fundamental algorithms and techniques and computer system concepts. Social and ethical responsibilities. Intended for Computer Science and Computer Systems Engineering majors. Prerequisites: MAT120, or MAT121, or MAT122.

CSC180AA 3 credits 4 periods

Computing for Scientists, Engineers and Medical/Health Specialists

Introduction to computers and technology and their impact in science, engineering and medical/health care occupations and on society. Explores technology, current topics in computing, applications and related issues. Use of application software to create scientific documents, spreadsheets, databases, e-mail and text files, and use of Internet browsers pertaining to science, engineering, and health care fields and personal use. Intended for students in the science, engineering, and medical/health care fields. Prerequisites: None.

CSC185 3 credits 3 periods

World Wide Web and Introductory Internet Programming

Organization of and access to information on the Internet. Design, creation and publication of interactive web pages with HTML, multimedia, animated custom graphics, applets and JavaScript programming. Ethical issues, including security and privacy on the World Wide Web. Prerequisites: None.

CSC200AA 3 credits 4 periods

Principles of Computer Science (Java)

Introduction to computer science. Issues and concepts throughout the field, including software development, data organization, machine architecture, algorithmic machines, and ethics in computing. Programming in Java. Prerequisites: CSC110 or (CSC100 or equivalent), and permission of instructor.

CSC210AA 3 credits 4 periods

Data Structures and Algorithms (Java)

Static and dynamic data structures and associated applications; recursive and iterative sorting and searching algorithms; introduction to object-oriented design and programming techniques; software engineering methods including design models and implementation/testing strategies; professional responsibilities; Java language. Prerequisites: CSC200.

CSC

CSC283 3 credits 4 periods

Bioinformatics and Scientific Computing

Introduction to Bioinformatics, including history, concepts, major genetic databases and access tools. Computer software and techniques for analyzing one nucleotide or protein sequence, searching for similar sequences, and aligning and comparing two or multiple sequences. Microarray analysis and phylogenetic trees. Application of standard software to bioinformatic computing tasks, including word processing of reports, and use of spreadsheets for statistical analysis and graphing. Text editors, Unix, Internet web site searching and construction, and ethics. Prerequisites: [BIO220 and (MAT120 or MAT121 or MAT122)] or Permission of instructor.

CSC294AA-AE 1-3 credits 1-4 periods

Special Topics in Computing

Investigation of special topics in computing technology and applications. Examination of industry trends to solve problems and/or investigate issues. Prerequisites: Permission of instructor.

COOPERATIVE EDUCATION (Work Experience)

Career and Cooperative Education Services .. SC 123 (480) 423-6523
Website address www.sc.maricopa.edu/career

Cooperative Education is a program combining classroom theory with supervised work experience. Students have the opportunity to earn college credit for planned growth in a job that is related to their career goals. A joint agreement is set up among the employer, the college and the student to facilitate the process. At Scottsdale Community College, Cooperative Education is available to students in nearly every discipline and is required in certain occupational programs. The coordinator of the program meets with students to determine their eligibility. The Cooperative Education staff helps students locate suitable positions which relate to their field of study. A student's present job may also qualify. Each student is assigned to a faculty-coordinator who monitors the student's progress by making on-site visits to the place of employment.

Prerequisites:

1. Must have successfully completed at least 12 college credits.
2. Must have earned at least a 2.6 Grade Point Average (GPA).
3. Must be concurrently enrolled in at least one class which is related to the student's major or career interest or by permission of program coordinator.
4. Must have authorization to work in the U.S. if not a U.S. citizen.
5. Must obtain a position related to the student's career field. The employer must be willing to abide by the responsibilities as outlined in the training agreement.

Determination of College Credit

1. Completion of a minimum of 80 hours of work per semester for each credit to be earned, with a maximum of four (4) credit hours per semester. A student may accumulate a total of six (6) credit hours. However, the number of credits which can be applied toward a degree may be limited by individual departmental requirements.
2. Successful achievement of one learning objective for each credit to be earned.
3. Completion of Final Report, Employer Evaluation of Student Performance and documentation of completed learning objectives.
4. Attendance at a Cooperative Education Professional Development activity. An alternative method of completing this requirement may be authorized by the program director.
5. Students receive a letter grade for the Cooperative Education experience. The grade is based on specific criteria and is awarded by the faculty-coordinator to whom the student is assigned.

Course Descriptions

Application Process

Special application for Cooperative Education is required in addition to the application for general admission to the college. Applications are available in the Career and Cooperative Education Services Office, SC 123, in the Student Center Building. It is suggested that interested students call (480) 423-6523 to make an appointment with the Director who will explain the program and determine each student's eligibility.

The prefix for the credits for which the student registers is determined by the academic department:

XXX296WC Cooperative Education 3 credits 15 periods

Tuition for the Cooperative Education credits is the same as for other academic credits.

Veterans and Financial Aid Benefits

Veterans and financial aid recipients must also have written departmental approval for any courses not listed as electives or core courses within a specific program. Failure to do so may result in a pro rata reduction in financial assistance.

CORPORATE COMPUTER TECHNOLOGY CCT

CIS Department Office CM 404 (480) 423-6588

CCT200 1 credit 2 periods

I-Net+ Certification

Exploration of technologies involved in Internet development. Includes e-Commerce, web site developing and networking. Prerequisites: None.

CCT260 3 credits 4 periods

Interconnecting Cisco Network Devices (CIS175SA)

Procedures for interconnecting existing computer networks. Emphasis on internetworking, layer usage, and software configuration. Covers router and switch usage, protocol suite and wide-area networking, as well as Internet protocol address and routing configuration. Also includes frame relay and X.25 configuration, access list traffic management, and alternate router access information. Prerequisites: None.

COUNSELING AND PERSONAL DEVELOPMENT CPD

Counseling Services SC 108 (480) 423-6524

Group counseling courses are designed to promote and enhance students' educational, career, and personal success. Included are basic orientation and personal-career development courses, as well as courses for special populations. Students are advised to enroll in only one counseling group concurrently.

CPD102AB 2 credits 2 periods

Career Exploration

Designed to assist students making career choices. Focuses on self-assessment in terms of educational and career opportunities and reasonable possibilities in the world of work. Includes assessment for personal/career interests, values, needs, attitudes, skills, and other potential, and exploration of occupational information to establish career and educational goals. Prerequisites: None.

CPD102AD 2 credits 2 periods

Eliminating Self-Defeating Behavior

Designed to help students change behaviors that work against their potential, i.e., inferior feelings, shyness, nervousness, stage fright, under achievement, etc. Focus on identifying undesirable thoughts, emotions and behaviors, for the purpose of developing alternative and more desirable thoughts, emotions and behaviors. Prerequisites: None.

CPD102AH 2 credits 2 periods

Stress Management

Reviews the sources of stress, the physiological effects and the psychological impact of stress on the individual. Provides strategies to reduce stress. Prerequisites: None.

CPD102AS 2 credits 2 periods

Conflict Resolution

Developing new skills for dealing effectively with everyday conflict and improving quality of one's own life. Opportunity to discuss issues and seek cooperative resolutions. Prerequisites: None.

CPD102AT 2 credits 2 periods

Building Self-Esteem

Practice in specific methods for building and keeping self-esteem. Personal assessment of attitudes, values, support systems, and goals. Prerequisites: None.

CPD103BA 2 credits 2 periods

Women in Transition

Designed to assist and support women who are experiencing life transitions. Emphasis on assessing self-potential, increasing self-confidence, managing life change, and exploring educational/career/life options in terms of the realities of roles for women today. Prerequisites: None.

CPD103BB 2 credits 2 periods

Men in Transition

Designed to assist men who are experiencing life transitions. Emphasis on assessing potential, increasing self-confidence, managing change, exploring educational/career options, and exploring men's roles in a changing society. Prerequisites: None.

CPD103BC 2 credits 2 periods

African American Cultural Pride and Awareness

Develop an awareness of cultural roots, history, and traditions with emphasis on the shaping of personal identity, social, career, and educational decisions. Prerequisites: None.

CPD103BD 2 credits 2 periods

Latino/Hispanic American Pride and Awareness

Develop an awareness of cultural roots, history, and traditions with emphasis on the shaping of personal identity, social, career, and educational decisions. Prerequisites: None.

CPD103BE 2 credits 2 periods

Native American Cultural Pride and Awareness

Develop an awareness of cultural roots, history, and traditions with emphasis on the shaping of personal identity, social, career, and educational decisions. Prerequisites: None.

Course Descriptions

CPD103BH 2 credits 2 periods
Male-Female Communication

Designed to provide students with a better understanding of male-female characteristics and how that along with a renewed emphasis on basic communication skills will improve communication between the sexes. Prerequisites: None.

CPD103BL 2 credits 2 periods
Dynamics of Leadership

Designed to provide strategies that may be used when assuming leadership roles. Focus on improving supervisory confidence through the development of appropriate competitive behaviors, problem-solving skills, and techniques of leadership. Prerequisites: None.

CPD108 1 credit 1 period
Personal Money Management for College Students

Designed to assist students in examining values related to spending, borrowing and saving money. Identify financial priorities and responsibilities associated with debt. Develop and follow a personal budget plan and learn strategies for maintaining a financially balanced personal life. Prerequisites: None.

CPD110 2 credits 2 periods
Assessment and Planning for University Transfer

Designed for undecided students planning to transfer to a university. Assessment of individual needs, priorities, interests and abilities. Investigates university options to assist transfer-oriented students in selecting a major and specific university programs best suited to their needs. Prerequisites: None.

The following Success Orientation Seminar courses, CPD150 and CPD150 with modules, are designed especially for incoming freshmen and returning adult students enrolling in community college classes. These courses help students develop study skills, learning strategies, and career plans so they may improve their chances of academic success.

CPD150 3 credits 3 periods
Strategies for College Success

Focus on increasing student success through college orientation and personal growth, study skills development, and educational and career planning. Prerequisites: None.

CPD150AA 1 credit 1 period
College Orientation and Personal Growth (AAA150AA)

Emphasis on increasing student success through college orientation, identification of learning style and the use of time management, goal-setting, and interpersonal communication strategies. Prerequisites: None.

CPD150AB 1 credit 1 period
Study Skills Development (AAA150AB)

Emphasis on increasing student success through the use of study strategies including materials organization, note-taking, reading, test-taking, memory, and critical and creative thinking. Prerequisites: None.

CPD150AC 1 credit 1 period
Educational and Career Planning (AAA150AC)

Emphasis on increasing student success through educational and career planning. Prerequisites: None.

CPD160 3 credits 3 periods
Introduction to Multiculturalism

Examination of the multiple cultures and subcultures within the contemporary United States. Personal exploration of awareness and appreciation of multiculturalism. Activities for experiencing diverse cultural perspectives. Skills for recognizing, analyzing, and mediating cultural and psychological factors impacting conflict and accord between diverse cultures. Credit (P) or no credit (Z). Standard grading available according to procedures outlined in catalog. Prerequisites: None.

CPD195AA 0.5 credit 0.5 period
Special Topics: Counseling and Personal Development

Introduction to current topics and contemporary issues related to promoting and enhancing personal development. Prerequisites: None.

CPD195AB 1 credit 1 period
Special Topics: Counseling and Personal Development

Introduction to current topics and contemporary issues related to promoting personal development. Focuses on a variety of techniques and strategies to improve personal and interpersonal effectiveness. Prerequisites: None.

CRITICAL READING

CRE

Language/Communication Division LC 305 (480) 423-6459

ALSO SEE: Reading (RDG), pages 162 and 199.

CRE101 3 credits 3 periods
Critical and Evaluative Reading I

Emphasis on applying critical inquiry skills to varied and challenging reading materials. Includes analysis, synthesis, and evaluation through written discourse. Prerequisites: ENG101 and [reading placement test score of 41 or higher (ASSET), or grade of C or better in RDG091, or permission of instructor].



Course Descriptions

CULINARY ARTS

Hospitality, Tourism and Culinary Arts
Division Office AP 237A (480) 423-6578

ALSO SEE: Hospitality and Tourism/Hotel, Golf and Restaurant Management (HRM), page 173.

CUL110 2 credits 2 periods

Food Service Nutrition

Study of basic nutrition concepts with an emphasis on the nutritional concerns of restaurants and other types of food service operations. Focuses on nutrients in foods, the relationships to other nutrients and the planning of well-balanced menus throughout the life cycle. Prerequisites: None.

CUL115 2 credits 2 periods

Food Service Sanitation, Safety and Stewarding

Focuses on the theory and practice of food service safety and sanitation. Emphasis on understanding and applying the Hazard Analysis Critical Control Points (HACCP) concept. Reviews legal elements of food service sanitation based on requirements and recommendations of Maricopa County Health Department. Focuses on stewarding as an important kitchen support service with emphasis on appropriate practices and principles of receiving food and product rotation. Prerequisites: None.

CUL126 2 credits 2 periods

Food Costing, Purchasing and Inventory Control

Basic skills necessary to understand and utilize cost controls. Focus on measurements, recipe costing and yield analysis. Application of systems and practices for efficient food purchasing, storage, production, budgeting and inventory. Prerequisites: None.

CUL130 3 credits 6 periods

Hot Foods I

Studies all facets of hot foods; including vegetable preparation, stocks, sauces, soups and line work for an American-style grill. Emphasis on techniques, taste, speed, organization, communication, teamwork and the development of professional knife skills. Reviews ingredients, production and plating techniques unique to grill kitchens. Prerequisites: None.

CUL140 3 credits 3 periods

Culinary Principles and Kitchen Management I

Historical background of the culinary profession and food components. Overview of kitchen administration and responsibilities. Includes food history, tools and equipment, food preparation, tasting and sensory evaluation, stocks and sauces, herbs and spices, chocolates, vegetables, fruits, pasta, grains and cheeses. Prerequisites: None.

CUL150 2 credits 3 periods

Garde Manger I

Provides a foundation in Garde Manger. Includes equipment, sanitation and safety, production, salads, emulsified and non-emulsified dressings, sandwiches, cold sauces, salad condiments, knife skills, cleaning of salad greens, and spice and herb identification. Studies culinary terms and presentation techniques. Teaches cooking techniques such as poaching, sautéing, and grilling in the context of Garde Manger work. Prerequisites: None.

CUL

CUL160 3 credits 6 periods

Bakery and Pastry Production I

Theory and practice of operating a bakery or pastry shop in a hotel or restaurant kitchen. Provides experience in planning, ordering, scheduling and producing fine French and American pastries and baked goods. Emphasis on rapid, high-quality hand production of doughs, creams, fillings, cookies and breads. Prerequisites: None.

CUL170 2 credits 4 periods

Dining Room Operations I

Focuses on theory and practice of operating a casual dining room; includes set-up and clean-up, food and beverage service, proper etiquette, point-of-sale operation and presenting guest checks. Emphasis on service techniques and customer accommodations. Prerequisites: None.

CUL180 3 credits 3 periods

Food in History

Focuses on the history of foodstuffs, the story of cuisine and the social history of eating. Includes the relationship between people and what they eat, between particular foods and social behavior, and between dietary habits, customs and methods of cooking. Prerequisites: None.

CUL190 3 credits 3 periods

Catering Operations I

Studies theory and practice of planning and executing catering functions; includes initial customer contact and follow-up, room setup and scheduling, menu and incidental planning event execution and breakdown, billing and post-event follow-up. Prerequisites: None.

CUL210 2 credits 2 periods

Menu Planning and Facilities Design

Principles and techniques of menu planning and restaurant design for food service operations. Includes applications for health care institutions, commercial kitchens, and industrial facilities. Studies building codes and examines the relationships among equipment, staff and customers in the design of a facility. Prerequisites: None.

CUL230 3 credits 7 periods

Hot Foods II

Hot food product utilization, preparation and display for a fine dining kitchen. Focuses on classical preparation skills with an emphasis on contemporary food production, organization, communication, teamwork and plating skills. Prerequisites: CUL130.

CUL235 2 credits 2 periods

Advanced Culinary Techniques I - Meats

Theory and practice of the varied uses and preparation of protein products. Emphasis on butchering, creating stocks, soups and sauces, cooking methodologies, cost-effective applications, plating and selection of appropriate accompaniments and garnishes. Prerequisites: CUL230 or industry equivalent.

CUL236 2 credits 2 periods

Advanced Culinary Techniques II - Seafood

Theory and practice of the varied uses and preparation of seafood products. Emphasis on butchering, creating stocks, soups and sauces, cooking methodologies, cost-effective applications, plating and selection of appropriate accompaniments and garnishes. Prerequisites: CUL230 or industry equivalent.

Course Descriptions

CUL237 2 credits 2 periods

Advanced Culinary Techniques III - Game and Poultry

Theory and practice of the varied uses and preparation of game and poultry products. Emphasis on butchering, creating stocks, soups and sauces, cooking methodologies, cost-effective applications, plating and selection of appropriate accompaniments and garnishes. Prerequisites: CUL230 or industry equivalent.

CUL240 3 credits 3 periods

Culinary Principles and Kitchen Management II

Advanced culinary and management practices instruction. Emphasis on principles and terminology used in contemporary kitchens. Identification and use of fish, shellfish, and game. Understanding of wine, beer and spirits. Study of diversity of international cuisines and menu development. Special emphasis on management functions and practices for kitchen supervisors and chefs, staff hiring, training and evaluation, point of sale system components, cost accounting procedures, legal regulations and maintenance of records to understand and control profit and loss. Prerequisites: CUL140.

CUL245 2 credits 2 periods

Professional Kitchen Management Techniques

Theory and practice of the key elements of kitchen leadership. Emphasis on identifying leadership and communication skills, understanding employment laws, establishing performance criteria, developing accountability, utilizing motivational procedures and training practices, controlling labor and food costs, maintaining guest satisfaction and bottom line profits. Prerequisites: CUL240 or industry equivalent.

CUL250 2 credits 4 periods

Garde Manger II

Refinement of skills required in a Garde Manger Department. Preparation of appetizers, hors d'oeuvres, salads, salad dressings, use of grains and legumes, production of charcuterie and display pieces. Emphasis placed on eye appeal, texture, color contrast, artistic touch, taste and processing. Includes study of production and storage of ingredients, sanitation and hygiene standards. Prerequisites: CUL150.

CUL255 2 credits 2 periods

Advanced Garde Manger I - Salads and Sandwiches

Theory and practice of creating simple and complex salads and sandwiches. Emphasis on use of multiple ingredients for hot and cold products, dressings, emulsified oils and vinegars, condiments, production methodologies, cost-effective applications, plating and appropriate accompaniments and garnishes. Prerequisites: CUL250 or industry equivalent.

CUL256 2 credits 2 periods

Advanced Garde Manger II - Appetizers and Hors d'oeuvres

Theory and practice of the key elements in production of appetizers and hors d'oeuvres. Emphasis on ingredient selection, flavor combinations, preparation methodologies, cost-effective applications, displaying, garnishing and plating. Prerequisites: CUL250 or industry equivalent.

CUL260 2 credits 5 periods

Bakery and Pastry Production II

Focuses on theory and practice of operating a bakery or pastry shop in a hotel or restaurant kitchen. Provides experience in planning, ordering, scheduling and producing fine French and American pastries and baked goods. Emphasis placed on rapid, high-quality hand production and assembly of breads, desserts and garnishes. Prerequisites: CUL160.

CUL265 2 credits 2 periods

Professional Baking I - Base Products and Sauces

Theory and practice of the preparation of base products and sauces. Emphasis on creating finished products using basic components, creating sauces, and study of cooking methodologies, cost-effective applications and plating techniques. Prerequisites: CUL260 or industry equivalent.

CUL266 2 credits 2 periods

Professional Baking II - Breads and Rolls

Theory and practice of cooking techniques and procedures in the preparation of breads and rolls. Emphasis on hands-on production of scratch recipes, understanding formulas, ratios and ingredient interaction for producing high quality breads and rolls, cooking methodologies, and cost-effective applications. Focus on production of yeast-leavened breads, quick breads, laminated dough, unleavened dough and artisan style breads. Prerequisites: CUL260 or industry equivalent.

CUL267 2 credits 2 periods

Professional Baking III - Pastries, Pies and Cakes

Theory and practice of the preparation of complex pastries, pies and cakes. Emphasis on cooking methodologies, high quality cost-effective applications, and visually dramatic plating and garnishing techniques. Prerequisites: CUL260 or industry equivalent.

CUL268 2 credits 2 periods

Professional Baking IV - Decorative and Design Work

Theory and practice of the varied uses and preparation of chocolate and sugar as decorative items. Emphasis on applications for advanced show work, cooking methodologies, cost-effective applications for plated desserts and use as appropriate display pieces. Prerequisites: CUL260 or industry equivalent.

CUL270 3 credits 6 periods

Dining Room Operations II

Theory and practice of operating a formal dining room, including set-up and clean-up, food and beverage service, proper etiquette and tableside food preparation. Emphasis on formal etiquette and service practices for a dining room including buffet and banquet set-up and managerial duties. Prerequisites: CUL170.



Course Descriptions

DANCE

HPERD Division Office PE 149 (480) 423-6606
 Dance Department Office PE 151 (480) 423-6600

Scottsdale Community College offers a variety of dance courses each semester, designed for the absolute beginning dancer (beginning or level I courses), as well as those interested in transferring to a four-year university, pursuing a career in dance education or a career in performance (intermediate or level II, III and IV courses). Course offerings each semester include beginning through advanced level technique classes in Ballet, Modern Dance, Modern Jazz Dance, and Tap. Also offered each semester: Fundamentals of Choreography, Dance Production, Rhythmic Theory (music for dance), Dance Seminar (conditioning), Pointe, Dance Technology and Dance Performance which performs regularly on campus, in the community, in Arizona and throughout the United States. In addition to a variety of classes offered in the DAN prefix, a number of dance courses are also offered under the PED prefix. These courses include: Tap Dance and Social Dance. Students planning to transfer should be advised each semester for effective transition to a four-year institution. For further information on Scottsdale's dance program, please look under the PED prefix or contact (480) 423-6600. The following courses are suggested for students majoring in dance.

DAN115AA 1 credit 3 periods

Contemporary Dance Trends: Hip Hop

Theory and practice of Hip Hop dance. Development of movement quality and performance skills. Prerequisites: None. *Course Note: May be repeated for a total of two (2) credits.*

DAN115AB 1 credit 3 periods

Contemporary Dance Trends: Break Dancing

Theory and practice of Break Dancing. Development of movement quality and performance skills. Prerequisites: None. *Course Note: May be repeated for a total of two (2) credits.*

DAN125AA 1 credit 2 periods

Social Dance: Ballroom

Theory and practice of ballroom dance. Development of movement quality and performance skills individually, with a partner or in a group setting. May include Salsa, Mambo, Cha Cha Cha, Merengue, Rumba, East Coast Swing, Lindy Hop, West Coast Swing, Foxtrot, Waltz, American Tango, International Ballroom, or Ballroom Performance. Prerequisites: None. *Course Note: May be repeated for a total of four (4) credits.*

DAN125AB 1 credit 2 periods

Social Dance: Swing

Theory and practice of swing dance. Development of movement quality and performance skills individually, with a partner or in a group setting. May include East Coast Swing, Lindy Hop, West Coast Swing, or Foxtrot. Prerequisites: None. *Course Note: May be repeated for a total of four (4) credits.*

DAN125AC 1 credit 2 periods

Social Dance: Latin

Theory and practice of Latin dance. Development of movement quality and performance skills individually, with a partner or in a group setting. May include Salsa, Mambo, Cha Cha Cha, Merengue, Rumba, Bachata, International Latin Ballroom, or Latin Ballroom Performance. Prerequisites: None. *Course Note: May be repeated for a total of four (4) credits.*

DAN

DAN125AD 1 credit 2 periods

Social Dance: Country

Theory and practice of country dance. Development of movement quality and performance skills individually, with a partner or in a group setting. May include Two-Step, Cha Cha Cha, Swing, West Coast Swing, East Coast Swing, Waltz, Rhythm Two-Step, or Night Club and Line Dance. Prerequisites: None. *Course Note: May be repeated for a total of four (4) credits.*

DAN125AE 1 credit 2 periods

Social Dance: Tango

Theory and practice of tango dance. Development of movement quality and performance skills individually, with a partner or in a group setting. May include Argentine Tango, American Tango or International Style Tango. Prerequisites: None. *Course Note: May be repeated for a total of four (4) credits.*

DAN129 1 credit 3 periods

Musical Theatre Dance I

Introduction to the theory and practice of musical theatre dance at the beginning level. Development of movement quality and performance skills. Prerequisites: None.

DAN131 1 credit 3 periods

Ballet I

Introduction to the theory and practice of ballet at the beginning level. Development of movement quality and performance skills. Prerequisites: None. *Course Note: May be repeated for a total of two (2) credit hours.*

DAN132 1 credit 3 periods

Modern Dance I

Introduction to the theory and practice of modern dance at the beginning level. Development of movement quality and performance skills. Prerequisites: None. *Course Note: May be repeated for a total of two (2) credit hours.*

DAN133 1 credit 3 periods

Modern Jazz Dance I

Introduction to the theory and practice of modern jazz dance at the beginning level. Development of movement quality and performance skills. Prerequisites: None. *Course Note: May be repeated for a total of two (2) credit hours.*

DAN134 1 credit 3 periods

Ballet II

Theory and practice of ballet at the advanced beginning level. Development of movement quality and performance skills. Prerequisites: DAN131 or permission of instructor. *Course Note: May be repeated for a total of two (2) credit hours.*

DAN135 1 credit 3 periods

Modern Dance II

Theory and practice of modern dance at the advanced beginning level. Development of movement quality and performance skills. Prerequisites: DAN132 or permission of instructor. *Course Note: May be repeated for a total of two (2) credit hours.*

Course Descriptions

DAN136 1 credit 3 periods
Modern Jazz Dance II
 Theory and practice of modern jazz dance at the advanced beginning level. Development of movement quality and performance skills. Prerequisites: DAN133 or permission of instructor. *Course Note: May be repeated for a total of two (2) credit hours.*

DAN138 1 credit 1 period
Dance Seminar I
 Level I scientific evaluation and in-depth discussion of the theory and practice of work done in dance technique class. Prerequisites: None. Corequisites: Any ballet, modern dance, or modern jazz dance technique course.

DAN140 1 credit 3 periods
Tap Dance I
 An introduction to the theory and practice of tap dance. May be repeated for a total of two (2) semester credit hours. Prerequisites: None.

DAN141 1 credit 3 periods
Dance Workshop
 An intensive experience in the process of choreography, performance, and production elements. May be repeated for a total of two (2) semester credit hours. Prerequisites: None.

DAN150 1 credit 3 periods
Dance Performance I
 An introduction to the process and practice of dance performance. May be repeated for a total of two (2) semester credit hours. Prerequisites: None.

DAN201AA-AC 1-3 credits 1-3 periods
Special Topics: Dance
 Exploration of current topics, issues and activities related to one or more aspects of dance. Prerequisites: Permission of instructor. *Course Note: Designed to offer special topics and/or specialized training for students in dance. Activities may also be appropriate for portfolio enhancement.*

DAN210 3 credits 3 periods
Dance Production I
 Introduction to the elements of light, sound, and scenery as they relate to the art of dance. Prerequisites: None.

DAN211 3 credits 3 periods
Dance Production II
 Introduction to the theory and practice of makeup and costuming as they relate to dance. Prerequisites: None.

DAN221 2 credits 3 periods
Rhythmic Theory for Dance I
 Exploration of the ways in which music, time, pitch and energy work with the art of dance. Emphasis on reading and writing music notation and performing movement that correlates to the notation and vice versa. Prerequisites: None.

DAN231AA 2 credits 5 periods
Ballet III: Intensive
 Theory and intensive practice of ballet at the beginning intermediate level. Development of movement quality and performance skills. Prerequisites: DAN134 or permission of instructor. *Course Note: May be repeated for a total of four (4) credit hours.*

DAN232 1 credit 3 periods
Modern Dance III
 Theory and practice of modern dance at the beginning intermediate level. Development of movement quality and performance skills. Prerequisites: DAN135 or permission of instructor. *Course Note: May be repeated for a total of two (2) credits.*

DAN232AA 2 credits 5 periods
Modern Dance III: Intensive
 Theory and intensive practice of modern dance at the beginning intermediate level. Development of movement quality and performance skills. Prerequisites: DAN135 or permission of instructor. *Course Note: May be repeated for a total of four (4) credits.*

DAN233 1 credit 3 periods
Modern Jazz Dance III
 Theory and practice of modern jazz dance at the beginning intermediate level. Development of movement quality and performance skills. Prerequisites: DAN136 or permission of instructor. *Course Note: May be repeated for a total of two (2) credits.*

DAN233AA 2 credits 5 periods
Modern Jazz Dance III: Intensive
 Theory and intensive practice of modern jazz dance at the beginning intermediate level. Development of movement quality and performance skills. Prerequisites: DAN136 or permission of instructor. *Course Note: May be repeated for a total of four (4) credits.*

DAN234AA 2 credits 5 periods
Ballet IV: Intensive
 Theory and intensive practice of ballet at the advanced intermediate level. Development of movement quality and performance skills. Prerequisites: DAN231AA or permission of instructor. *Course Note: May be repeated for a total of four (4) credit hours.*

DAN235 1 credit 3 periods
Modern Dance IV
 Theory and practice of modern dance at the intermediate level. Development of movement quality and performance skills. Prerequisites: DAN232 or permission of instructor. *Course Note: May be repeated for a total of two (2) credits.*

DAN235AA 2 credits 5 periods
Modern Dance IV: Intensive
 Theory and intensive practice of modern dance at the advanced intermediate level. Development of movement quality and performance skills. Prerequisites: DAN232AA or permission of instructor. *Course Note: May be repeated for a total of four (4) credits.*

DAN236 1 credit 3 periods
Modern Jazz Dance IV
 Theory and practice of modern jazz dance at the intermediate level. Development of movement quality and performance skills. Prerequisites: DAN233 or permission of instructor. *Course Note: May be repeated for a total of two (2) credit hours.*

Course Descriptions

DAN236AA 2 credits 5 periods
Modern Jazz Dance IV: Intensive
 Theory and intensive practice of modern jazz dance at the advanced intermediate level. Development of movement quality and performance skills. Prerequisites: DAN233AA or permission of instructor. *Course Note: May be repeated for a total of four (4) credits.*

DAN237 1 credit 1 period
Ballet Pointe I
 An introduction to the theory and practice of pointe work at the beginning level. Development of strength and movement quality. May be repeated for a total of two (2) semester credit hours. Prerequisites: DAN134 or permission of instructor. Corequisites: DAN231 or DAN234.

DAN238 1 credit 1 period
Dance Seminar II
 Level II scientific evaluation and in-depth discussion of the theory and practice of work done in dance technique class. Prerequisites: DAN138 or permission of instructor. Corequisites: Any ballet, modern dance, or modern jazz dance technique course.

DAN241 3 credits 3 periods
Dance Notation I
 Focuses on the study of a system of Movement Notation known as Labanotation. Includes using notation as an aid in analyzing, clarifying, understanding and recording movements of all kinds. Prerequisites: DAN131 or DAN134 or permission of instructor.

DAN264 3 credits 3 periods
Choreography I
 Study of basic dance choreography to include construction of a phrase, structure and form in a composition and the basic elements of time, space and energy. Prerequisites: None.

DAN272 2 credits 3 periods
Dance Technology
 Survey of the expanding field of technology as it pertains to the study and performance of dance. Prerequisites: DAN264 or permission of instructor.

DAN280 2 credits 6 periods
Dance Practicum
 A culmination of coursework for the dance major requiring completion of an extended choreographic work from conception to performance. Also requires a final evaluative paper on the successes and challenges encountered throughout the project. Prerequisites: Permission of instructor.

DAN285AA 3 credits 6 periods
Multimedia Performance Ensemble I (MUP285AA)
 Provides students with opportunities to gain training in one or more aspects of arts and entertainment including dance technology and performance, music production and performance and other aspects of live performance production. Assigned projects may be individualized and/or a group effort. Emphasis on developing professional skills of students in their particular area/s of specialization through practical experience and interaction with industry professionals and development of student performance portfolios. Prerequisites: Permission of instructor.

DAN285AB 3 credits 6 periods
Multimedia Performance Ensemble II (MUP285AB)
 Provides students with opportunities to gain training in one or more aspects of arts and entertainment including dance technology and performance, music production and performance and other aspects of live performance production. Assigned projects may be individualized and/or a group effort. Emphasis on developing professional skills of students in their particular area/s of specialization through practical experience and interaction with industry professionals and development of student performance portfolios. Prerequisites: Permission of instructor.

DAN285AC 3 credits 6 periods
Multimedia Performance Ensemble III (MUP285AC)
 Provides students with opportunities to gain training in one or more aspects of arts and entertainment including dance technology and performance, music production and performance and other aspects of live performance production. Assigned projects may be individualized and/or a group effort. Emphasis on developing professional skills of students in their particular area/s of specialization through practical experience and interaction with industry professionals and development of student performance portfolios. Prerequisites: Permission of instructor.

DAN285AD 3 credits 6 periods
Multimedia Performance Ensemble IV (MUP285AD)
 Provides students with opportunities to gain training in one or more aspects of arts and entertainment including dance technology and performance, music production and performance and other aspects of live performance production. Assigned projects may be individualized and/or a group effort. Emphasis on developing professional skills of students in their particular area/s of specialization through practical experience and interaction with industry professionals and development of student performance portfolios. Prerequisites: Permission of instructor.

DANCE HUMANITIES DAH

HPERD Division Office PE 149 (480) 423-6606
 Dance Department Office PE 151 (480) 423-6600

DAH100 3 credits 3 periods
Introduction to Dance
 Overview of the field of dance focusing on origins, historical development, and cultural characteristics of the various styles of dance. Prerequisites: None. *(Meets humanities requirement.)*

DAH110 3 credits 3 periods
Dance in Film
 Survey of the history and development of dance in film and video including basic film technology and critical analysis and evaluation. Prerequisites: None.

DAH201 3 credits 3 periods
World Dance Perspectives
 Exploration, analysis, synthesis, and evaluation of the role of dance in various cultures around the world. Prerequisites: ENG101, or ENG107, or equivalent. DAH100 strongly suggested but not required.

Course Descriptions

DRAFTING (Architectural Technology)

See ARCHITECTURAL TECHNOLOGY
(Computer-Aided Drafting) (ARC), page 123.

EARLY CHILDHOOD DEVELOPMENT **ECH**

Social/Behavioral Sciences Division SB 130 (480) 423-6206

ALSO SEE: Child/Family Studies (CFS), page 134
Early Education (EED), page 151
Family and Consumer Science (FCS), page 165
Infant/Toddler Development (ITD), page 175

ECH120 1 credit 1 period **Contemporary Issues in Early Childhood (CFS120)**

Designed to develop understanding of a broad range of contemporary issues that impact the child in today's society. Course directed at preservice and in-service professionals. May be repeated for credit. Prerequisites: None.

ECH126AB 1 credit 2 periods **Play Lab-Toddlers**

Participant observation within a laboratory play environment with children 13-35 months of age. Focus on preparation, management and evaluation of developmentally appropriate activities. Prerequisites: None.

ECH126AC 1 credit 2 periods **Play Lab-Preschoolers**

Participant observation within a laboratory play environment with children 3-5 years of age. Focus on preparation, management and evaluation of developmentally appropriate activities. Prerequisites: None.

ECH126AD 1 credit 2 periods **Play Lab-Primary**

Participant observation within a laboratory play environment with children 6-8 years of age. Focus on preparation, management and evaluation of developmentally appropriate activities. Prerequisites: None.

ECH128 3 credits 4 periods **Early Learning: Play and the Arts**

Examines theory, research and practices relating to play and creative arts in early childhood. Considers practical constraints and alternative perspectives. Includes participation in a play environment with young children. Prerequisites: None.

ECH176 3 credits 3 periods **Child Development (CFS176)**

Study of the science of human development from conception through adolescence. Includes observation skills, parent and adult roles in the lives of children, and contemporary issues. Prerequisites: None.

ECH183 1 credit 1 period **Infant/Toddler Learning Materials (ITD183)**

Safety and design features of commercial, homemade, and household learning materials for children from birth through 30 months of age. Focus on matching items with children's developmental levels. Prerequisites: None.

ECH237 1 credit 1 period **Media for Young Children**

Media production for and with young children. Emphasis on utilization for instruction. Prerequisites: None.

ECH272 1 credit 1 period **Science for the Young Child**

Methods and techniques for encouraging beginning scientific thinking among young children. Focus upon the theory of Jean Piaget. Prerequisites: None.

ECH273 1 credit 1 period **Math for the Young Child**

Methods and techniques for encouraging the beginnings of mathematical/logical thought with young children. Focus upon the theory of Jean Piaget. Prerequisites: None.

ECH276 1 credit 1 period **Musical Beginnings**

Considers responses to sound, rhythm and melody from infancy through early childhood. Management and planning for listening, singing, moving and creating rhythms and music with young children. Prerequisites: None.

ECH285 2 credits 3 periods **Assistant Teaching in Early Childhood Settings I**

Supervised application of principles of child growth and development in early childhood programs by assisting a classroom teacher in providing age-appropriate play and learning experiences in one of the following settings: a child care center, a preschool, a primary grade classroom or a special education program. Prerequisites: CFS176 or ECH176 and permission of instructor.

ECH286 2 credits 3 periods **Assistant Teaching in Early Childhood Settings II**

Continued supervised application of principles of child growth and development in early childhood programs by assisting a classroom teacher in providing age-appropriate play and learning experiences in one of the following settings: a child care center, a preschool, a primary grade classroom or a special education program. Prerequisites or Corequisites: ECH285 and permission of instructor.



Course Descriptions

EARLY EDUCATION

EED

Social/Behavioral Sciences Division SB 130 (480) 423-6206

EED200 3 credits 3 periods

Foundations of Early Childhood Education

Overview of early childhood education in American society, including current issues and responsibilities. Emphasis on issues of professionalism, ethics and program types. Opportunities for students to explore potential career paths. Includes field experience. Prerequisites: None.

EED212 3 credits 3 periods

Guidance, Management and the Environment

Principles for guiding young children in early care and education environments. Exploration of guidance, management, and how the environment impacts the lives of young children. Includes observation of classrooms of children ages birth to age five. Prerequisites: None.

EED215 3 credits 3 periods

Early Learning: Health, Safety, Nutrition and Fitness

Consideration of public health issues and safety procedures within early childhood settings. Overview of nutritional needs and issues of physical fitness and well-being in young children. Includes field experiences. Prerequisites: None.

EED220 3 credits 3 periods

Child, Family, Community and Culture

Examines family, community and cultural influences on development of the young child. Considers trends and threats to attachment, relationships and cultural identity. Includes social and emotional experiences and their impact on the developing brain. Prerequisites: None.

EED222 3 credits 3 periods

Introduction to the Exceptional Young Child

Overview of the exceptional learner (birth - age 5), one who differs from the average or the norm, with emphasis on observation, techniques, characteristics, identification, types of programs, and work with families. Issues related to learning exceptionalities, sensory and communication disorders, social and emotional problems, physical and health related disorders, and giftedness. Includes field experience. Prerequisites: None.

EED250 3 credits 3 periods

Early Literacy Development

Overview of emergent literacy, early literacy development, and appropriate early experiences with books, reading, and writing. Emphasis placed on reading and writing readiness, methods to enhance literacy development, and strategies for selecting and using children's books. Prerequisites: None.

EED255 3 credits 3 periods

Portfolio Development and Writing for the Profession

Portfolio development, completion, and presentation. Self-assessment and educational short-term and long-term planning, professional development, writing and critical learning included. Prerequisites: Completion of twelve (12) credit hours of EED coursework and permission of Program Coordinator.

EED260 1 credit 1 period

Early Childhood Infant/Toddler Internship

Work experience with infants and toddlers in early care and education settings. 80 hours of designated work per credit. Prerequisites: Permission of department. *Course Note: May be repeated for a total of six (6) credit hours.*

EED261 1 credit 1 period

Early Childhood Preschool Internship

Work experience with preschoolers in early care and education settings. 80 hours of designated work per credit. Prerequisites: Permission of department. *Course Note: May be repeated for a total of six (6) credit hours.*

EED276 3 credits 3 periods

Global Child Development

Exploration of the ways that biology and cultures influence the well-being and development of children around the world. Considers traditional and scientific views of the child, as well as threats to the well-being of the young in the contemporary world. Prerequisites: None.

EED278 3 credits 3 periods

Early Learning: Curriculum and Instruction

Considerations and evaluations of curriculum appropriate to the developmental characteristics of learners, birth through five years. Includes how early childhood standards, philosophies, and program settings relate to the teaching, learning, and assessment process. Includes field experience. Prerequisites: EED200.

EED280 3 credits 3 periods

Standards, Observation and Assessment in Early Education

Overview of Early Education standards, observation techniques and assessment methodologies. Also includes ethical responsibilities and the application of standards within varied educational settings. Prerequisites: CFS/ECH176 or CFS205 or permission of instructor.

ECONOMICS

ECN

Social/Behavioral Sciences Division SB 130 (480) 423-6206

ECN111 3 credits 3 periods

Macroeconomic Principles

A descriptive analysis of the structure and functioning of the American economy. Emphasis on basic economic institutions and factors that determine national income and employment levels. Consideration given to the macroeconomic topics of national income, unemployment, inflation and monetary and fiscal policies. Prerequisites: None.

ECN112 3 credits 3 periods

Microeconomic Principles

Microeconomic analysis including the theory of consumer choice, price determination, resource allocation and income distribution. Includes noncompetitive market structures such as monopoly and oligopoly; and the effects of government regulation. Prerequisites: None.

Course Descriptions

EDUCATION

Social/Behavioral Sciences Division SB 130 (480) 423-6206

Students planning to enter the teaching profession should consult early with the institution to which they plan to transfer. Universities differ in their recommendations for the first two years of college work. States also differ in their certification requirements for various teaching levels (elementary or secondary) and different teaching areas (ESL, early childhood, special needs, etc.). A strong general studies transfer program and a start toward an area of subject teaching proficiency are recommended. Students planning to teach in the state of Arizona may need to include Arizona Constitution (POS221) and United States Constitution (POS222). See college advisement center for current Arizona General Education Curriculum information.

In addition, SCC offers a program that allows people with bachelor's degrees to become teachers in one year. A fast-track schedule is designed to help ease the state's teacher shortage (see Programs section, page 115). Applications into this program will be accepted from adults who have earned a bachelor's degree in any discipline and are seeking a career in the teaching profession. For further information on this program, contact the program director at (480) 423-6217.

EDU208 1 credit 1 period Introduction to Structured English Immersion

Emphasis on understanding English Language Learners (ELL) in the mainstream classroom. Brief history, culture, theory, methods, and an introduction to both the English Language Proficiency (ELP) standards and the Arizona Structured English Language Proficiency (SELP) test covered. Includes review of alternative methods of assessment. Prerequisites: None.

EDU217 3 credits 3 periods Methods for the Structured English Immersion (SEI)/ESL Student

Methods of planning, developing, and analyzing lesson plans in all content areas to meet English Language Learners (ELL) Standards. Emphasis on components of curriculum content, teaching strategies, development and evaluation/adaptation of teaching materials, and the role of culture in learning. Examines the alignment of ELL Proficiency Standards to the Arizona Language Arts Academic Standards. Covers multiple assessment techniques, tracking of student progress using the Stanford English Language Proficiency (SELP), and use of assessment results for placement and accommodation. Prerequisites: Formal admission to a state approved undergraduate teacher preparation program and EDU225. *Course Note: Approved school-based practicum is required. This course incorporates curricular framework for the 45-clock hour requirement for SEI endorsement through the Arizona Department of Education. Designed for undergraduate students.*

EDU221 3 credits 3 periods Introduction to Education

Overview of the historical, political, economic, social, and philosophical factors that influence education and make it so complex. Opportunity for students to assess their interest and suitability for teaching. Prerequisites: None. *Course Note: Requires minimum of 30 hours of field experience in elementary or secondary classroom environment.*

EDU

EDU222 3 credits 3 periods Introduction to the Exceptional Learner

Overview of the exceptional learner, one who differs from the average or normal, with emphasis on factors relating to current practices, identification, characteristics, and educational adaptations. Issues related to mildly disabled, severely disabled, emotionally and behaviorally disordered, mentally retarded, and gifted students. Prerequisites: None. *Course Note: May include approved school-based practicum.*

EDU223AF 3 credits 3 periods Assessment in Special Education

Investigation into the concepts, laws, issues, and procedures that relate to the formal and informal assessment of students with disabilities. Covers educational achievement tests and standardized diagnostic tests for students with disabilities as well as intelligence and adaptive behavior measurements. Includes school-based practicum. Prerequisites: Baccalaureate Degree and formal admission to a state approved post-baccalaureate teacher preparation program and (EDU223AA, or EDU223AB, or EDU223AC, or EDU223AD) and EDU222 and EDU226.

EDU225 3 credits 3 periods Foundations for Serving English Language Learners (ELL)

Rationale for and current educational and legal issues for English Language Learners (ELL). Comparison and evaluation of various types of language educational models including Structured English Immersion (SEI), English as a Second Language (ESL) and bilingual. Prerequisites: None. *Course Note: Approved school-based practicum is required. This course meets the Arizona Department of Education requirement for the provisional SEI Endorsement.*

EDU228 3 credits 3 periods Structured English Immersion (SEI) and English as a Second Language (ESL) Teaching Methods

Methods of developing lesson plans in language arts, science, math, social studies, and culture for the English Language Learners (ELL). Emphasis on components of curriculum content, teaching techniques, development and evaluation of teaching materials. Prerequisites: Must hold a provisional or standard elementary, secondary or special education teaching certificate and (EDU225 or departmental approval).

EDU230 3 credits 3 periods Cultural Diversity in Education (EPD230)

Examination of the relationship of cultural values to the formation of the child's self-concept and learning styles. Examination of the role of prejudice, stereotyping and cultural incompatibilities in education. Emphasis on teacher preparation (preservice and/or inservice) to offer an equal educational opportunity to students of all cultural groups. Prerequisites: None.

EDU240 3 credits 3 periods Methods for Teaching Structured English Immersion (SEI) and English as a Second Language (ESL)

Methods of developing lesson plans in language arts, science, math, social studies, and culture for English Language Learners (ELL). Emphasis on components of curriculum content, teaching techniques, development and evaluation of teaching materials. Includes school-based practicum. Prerequisites: Baccalaureate Degree and formal admission to a state approved post-baccalaureate teacher preparation program and (EDU225 or departmental approval), or must have a provisional or standard elementary, secondary, or special education teaching certificate.

Course Descriptions

EDU243 3 credits 3 periods
Reading and Writing in an English as a Second Language (ESL)/Bilingual Setting
Introduction to English as a Second Language (ESL) terminology, second language acquisition theories and reading terminology. Teaching techniques, strategies, and learning activities as well as reading comprehension skills and writing skills covered. Prerequisites: EDU225 and must hold a provisional or standard elementary, secondary or special education teaching certificate.

EDU246 3 credits 3 periods
Teaching and Assessment of English Language Learners (ELL)
Teaching and assessment of English Language Learners (ELL). Covers differentiated instruction, special education needs vs. language needs, learning environments in multilingual and multicultural classrooms, identification, exiting, and ongoing assessment of student learning. Legal issues and historical perspectives also covered. Linking assessment to instruction and the review of methods and techniques employed for language and academic assessment included. Standards emphasized. Prerequisites: EDU225.

EDU247 3 credits 3 periods
Practicum for English as a Second Language (ESL)/Bilingual Teachers
Provides an opportunity to receive guided practical, on-site experience working with English Language Learners (ELL). Requires observations of ELL students in a variety of settings, evaluation of teaching techniques, and critical review of academic standards as they relate to English as a Second Language (ESL) learners. Prerequisites: (EDU225 and EDU230 and ENG213), and (EDU228 or EDU240 or EDU241), and must hold a provisional or standard elementary, secondary or special education teaching certificate.

EDU250 3 credits 3 periods
Overview of the Community Colleges
The history, functions, organization and current issues in the community/junior college with emphasis on the Arizona community colleges. Prerequisites: None.

EDU269 3 credits 3 periods
Methods of Integrating Technology into Curriculum
Overview and practical application of teaching methodology for integrating technology into curriculum development for teachers. Examination of the necessary skills students need to meet national technology standards. Lesson plan development emphasized. Prerequisites: EDU260 or Permission of Department.

EDU270 3 credits 3 periods
Learning and the Brain
Teaching and learning issues within a cognitive processes content. Covers emotion, memory, and recall as well as early brain development and its relationship to learning. Emphasis on current neuroscientific brain research and how it impacts teaching practice in preK-12 classrooms. Prerequisites: None.

EDU270AA 3 credits 3 periods
Elementary Reading and Decoding
Focus on the theories, methods and models of the teaching and learning processes of reading in the elementary grades. Approved school-based practicum required. Prerequisites: None.

EDU270AB 3 credits 3 periods
Secondary Reading and Decoding
Focus on the theories, methods and models of teaching literacy and decoding in the content areas of secondary grades. Prerequisites: Must be a certified K-12 teacher or have permission of department chair or program director.

EDU271 3 credits 3 periods
Phonics Based Reading and Decoding
Overview of research, curricular content, and instructional practices associated with Research Based Systematic Phonics Instruction (RBSPI) and other methods for teaching reading. Emphasis on methods mandated by Arizona legislation. Covers the history of written language, alphabetic reading and writing systems, and implementation of effective methods for reading instruction. Approved school-based practicum required. Prerequisites: None.

EDU272 3 credits 3 periods
Educational Psychology
Focus on the study and application of psychological principles, theories, and methodologies related to teaching and learning. Emphasis on developmental, learning, and motivational theories. Current trends also covered. Prerequisites: PSY101 or approval of instructor.

EDU275 3 credits 3 periods
Diagnosis and Remediation of Reading for K-12
Fundamentals of diagnosis and remediation of reading problems for K-12. Administration, analysis and interpretation of informal diagnostic procedures and use of assessment results in planning a program of remediation. The Diagnostic Teaching of Reading emphasized. Prerequisites: EDU270AA or EDU270AB, and must hold a provisional or standard elementary, secondary or special education teaching certificate.

EDU276 3 credits 3 periods
Classroom Management
Classroom management techniques. Classroom discipline models, student behavior and misbehavior, group dynamics, student self-motivation and learning styles covered. State Board of Education Professional Teaching Standards emphasized. Approved school-based practicum required. Prerequisites: None.

EDU279 3 credits 4.5 periods
Reading Practicum K-12
Focus on the practical application of current philosophical theories, methods, and models of assessment and instruction for remediation of reading. Prerequisites: EDU270AA or EDU270AB, and must hold a provisional or standard elementary, secondary or special education teaching certificate.

EDU285 2 credits 2 periods
Education Seminar
Special topics in education with an emphasis on current issues not covered in education courses. May be repeated for a total of six (6) credit hours. Prerequisites: Departmental Approval. *Course Note: The proposed courses have been reviewed by the Arizona Department of Education, the State Board of Education and the Office of Superintendent for Public Instruction. The courses cover all of the state standards. The content of the courses prepares the student to apply for state teaching certification. A Bachelors degree is also required for this certification.*

Course Descriptions

EDU285AA 1 credit 1 period
Education Program Seminar
Overview of the teacher education program model, State Teaching Standards and the Arizona Educator Proficiency Assessments. Educational program policies and procedures emphasized. Includes basic skills assessment and fingerprinting regulations. Prerequisites: None.

EDU285AB 1 credit 1 period
Current Perspectives in Education
Focus on the importance of state standards and their relationship to teaching and learning. Instructional design tools for standard based activities and their application in the classroom emphasized. Includes instructional design, resource management, and assessment rubrics. Educational program policies and procedures also covered. Prerequisites: Formal admission to a state approved undergraduate teacher preparation program.

EDU288AA 8 credits 5 periods
Student Teaching Lab - Elementary
Supervised student teacher practicum. Emphasis on the provision of instruction to learners. Covers lesson plan development, classroom procedures, classroom management, and educator professionalism. Includes learner preparation, learner engagement, and learner outcome awareness. Prerequisites: Baccalaureate Degree and formal admission to a state approved post-baccalaureate teacher preparation program, and (EDU240, EDU285AC, EDU287AC, EDU290, EDU293, and EDU295) and departmental approval.

EDU288AC 8 credits 5 periods
Student Teaching Lab - Special Education
Supervised student teacher practicum. Emphasis on the provision of instruction to learners. Covers lesson plan development, classroom procedures, classroom management, and educator professionalism. Includes learner preparation, learner engagement, and learner outcome awareness. Prerequisites: Baccalaureate Degree and formal admission to a state approved post-baccalaureate teacher preparation program, and (EDU223AA, EDU223AB, EDU223AC, EDU223AD, EDU223AF, EDU226, EDU285AC, EDU287AC, and EDU293) and Departmental Approval.

EDU290 3 credits 3 periods
Science Methods and Curriculum Development
Overview and practical application of teaching elementary science. Covers teaching strategies, learning environments, teaching resources, and use of technology. Emphasis on State Board of Education Professional Teaching Standards. Approved school-based practicum required. Prerequisites: Baccalaureate Degree and formal admission to a state approved post-baccalaureate teacher preparation program.

EDU291 3 credits 3 periods
Children's Literature (ENH291)
Review of folk and modern literature from a variety of world cultures, including application of literary criteria to folk and modern literature for children. Prerequisites: None.

EDU293 3 credits 3 periods
Mathematics Methods and Curriculum Development
Overview and practical application of teaching mathematics in K-8 grades. Development of lesson plans and assessment instruments emphasized. Current trends, State Board of Education Professional Teaching Standards and National Council of Teachers of Mathematics Standards also covered. Approved school-based practicum required. Prerequisites: Baccalaureate Degree and formal admission to a state approved post-baccalaureate teacher preparation program.

EDU294 3 credits 3 periods
Multicultural Folktales (ENH294, STO294)
Study of multicultural folktales, exploring the impact of the oral tradition in American society and showing classroom applications. Prerequisites: None.

EDU295 3 credits 3 periods
Social Studies Methods and Curriculum Development
Overview of teaching elementary social studies. Topics include lesson plans preparation, teaching strategies, assessments, classroom management techniques and teaching resources. Emphasis on State Board of Education Professional Teaching Standards. Approved school-based practicum required. Prerequisites: Baccalaureate Degree and formal admission to a state approved post-baccalaureate teacher preparation program.

EDU298AA 1 credit 1 period
Special Projects
Organized and tailored around the interests and needs of the individual student. Structured to provide an atmosphere of individualized research and study paralleled by professional expertise and guidance. Professional-type facilities and equipment are made available for student use. Allows the best aspects of independent study and individualized learning to be combined to maximize student development. Prerequisites: Departmental approval.

EDUCATION PROFESSIONAL DEVELOPMENT EPD

Social/Behavioral Sciences Division SB 130 (480) 423-6206

EPD243 3 credits 3 periods
Reading and Writing in an English as a Second Language (ESL)/Bilingual Setting
Introduction to English as a Second Language (ESL) terminology, second language acquisition theories and reading terminology. Teaching techniques, strategies, and learning activities as well as reading comprehension skills and writing skills covered. Prerequisites: (EDU/EPD220 or EDU225) and must hold a provisional or standard elementary, secondary or special education teaching certificate.

EPD247 3 credits 3 periods
Practicum for English as a Second Language (ESL)/Bilingual Teachers
Provides an opportunity to receive guided practical, on-site experience working with English Language Learners (ELL). Requires observations of ELL students in a variety of settings, evaluation of teaching techniques, and critical review of academic standards as they relate to English as a Second Language (ESL) learners. Prerequisites: (EDU/EPD220 or EDU225), or EDU/EPD230, or ENG213, or (EDU228 or EDU240 or EDU241), and must hold a provisional or standard elementary, secondary or special education teaching certificate.

Course Descriptions

EMERGENCY MEDICAL TECHNOLOGY EMT

Health Sciences Division Office SB 132 (480) 423-6225

EMT101 0.5 credit 0.5 period Cardiopulmonary Resuscitation/Basic Cardiac Life Support (HLR101)

Designed to train students in the skills of cardiopulmonary resuscitation to include mouth-to-mouth, mouth-to-mask and cardiac compression, stabilization of adult, infant and child victims with airway obstruction, respiratory, and cardiac arrest. Prerequisites: None.

EMT104 8 credits 9.45 periods Basic Emergency Medical Technology (FSC104)

Techniques of emergency medical care in accordance with national and state curriculum. Study of the human body, patient assessment, treatment of medically or traumatically compromised patients, special hazards, and medical operations. IV monitoring, Sudden Infant Death Syndrome (SIDS), patient-assisted medication administration, automated external defibrillators, and blood-glucose monitoring. Includes participation in two eight-hour clinical rotations through a local emergency department scheduled during the semester outside normal class hours. Requires personal pocket mask, stethoscope, pen light, and trauma scissors. Prerequisites: Must be at least 18 years of age prior to applying to the BLS (Basic Life Support) Training Program per Arizona Revised Statutes, and must have a validation in Basic Life Support (BLS) Health Care Provider/Professional Rescuer. Minimum ninth grade level reading proficiency on the Nelson-Denney Examination or appropriate Reading course placement score. Proof of: TB testing or chest x-ray with a negative result within six (6) months prior to registration; immunity to rubella (German Measles) and rubeola.

EMT200 2 credits 2.7 periods Refresher Course for Certified Emergency Medical Technicians

Designed to meet National and Arizona Department of Health Services (A-DHS) recertification for EMTs. Enhances the knowledge base of the Emergency Medical Technician (EMT) and reinforces basic skills competencies. Prerequisites: Current validation in Basic Life Support (BLS) Health Care Provider/Professional Rescuer or permission of instructor.

EMT200AA 0.6 credits 0.6 period EMT-Basic Certification Renewal Challenge

Designed to contribute to Arizona Department of Health Services (A-DHS) Bureau of Emergency Medical Services (B-EMS) recertification requirements for Emergency Medical Technician Basic (EMTB) according to the U.S. Department of Transportation (DOT) EMT-Basic National Curriculum and the Arizona EMT Basic Refresher Curriculum Guidelines. Prerequisites: Current validation in Basic Life Support (BLS) Health Care Provider/Professional Rescuer or proof of current registry with the National Registry of Emergency Medical Technicians (NREMT).

EMT200AB 1 credit 1 period EMT-Basic Certification Expanded Renewal Challenge

Designed to contribute to Arizona Department of Health Services (A-DHS) Bureau of Emergency Medical Services (B-EMS) recertification requirements for Emergency Medical Technician Basic (EMTB) according to the U.S. Department of Transportation (DOT) EMT-Basic National Curriculum and the Arizona EMT Basic Refresher Curriculum Guidelines. Prerequisites: Current Basic Life Support, American Heart Association Healthcare Provider CPR or equivalent, and current EMT Basic certification in the state of Arizona. Must be currently functioning as an EMT Basic.

EMT208 16 credits 20 periods Intermediate Emergency Medical Technology

Designed to meet U.S. Department of Transportation (U.S. DOT) Arizona Department of Health Services (A-DHS) Office of Emergency Medical Services (O-EMS) requirements for EMT-Intermediate. Provides advanced knowledge and skills related to hypoperfusion state, respiratory arrest or insufficiency, seizure states, cardiovascular emergencies, unconscious states of undetermined etiology, head injury with altered levels of consciousness, and chest trauma. Prerequisites: (MAT102 or equivalent or a satisfactory score on an applicable district placement exam) and ENG101, BIO160, EMT235, EMT236, EMT/FSC238, twenty-four hour Hazardous Materials Operations Level class or equivalent, and current course in American Heart Association Health Care provider or equivalent. Comprehensive written, oral, and practical evaluation on all prerequisite courses required prior to selection for this course. Valid Arizona Certification and be employed as an EMT for one full calendar year prior to registration in this course. Corequisites: EMT208AA.

EMT208AA 2 credits 10 periods Intermediate Emergency Medical Technology Practicum

Clinical and vehicular practicum in support of EMT208. Prerequisites or Corequisites: EMT208.

EMT215 3 credits 3 periods Stress and Emergency Services Professionals

Participative course designed to familiarize students with differences which exist in the socioeconomic, cultural, organizational, and technologic environments and the distress that can occur to emergency-care providers functioning in those arenas. Physiologic, psychologic and behavioral manifestations of distress as it relates to emergency responders. Explores distress management options with emphasis on individual techniques and organizational programs. Prerequisites: Currently employed as prehospital-care provider or registered nurse working in the prehospital setting.

EMT235 3 credits 3 periods Emergency Cardiac Care

Designed to acquaint all levels of emergency care providers with basic electrocardiographic (ECG) rhythm analysis and interpretation and related care in a clinical and prehospital setting. Required content for the identification and treatment of cardiac emergencies. Prerequisites: EMT/FSC104 or permission of instructor.



Course Descriptions

EMT236 3 credits 3 periods

Pharmacology in an Emergency Setting

Designed for the Emergency Medical Technician dealing with the administration of emergency medications in the field as outlined in current paramedic legislation. In-depth coverage of medications enumerated in the algorithms of patient care as defined by the American Heart Association (AHA), Advanced Cardiac Life Support (ACLS). Coverage of medications that interact or interfere with the AHA ACLS algorithms. Indications, therapeutic effect, contraindications, toxicology, and side effects to medications. Prerequisites: EMT/FSC104 or permission of instructor. MAT082 or equivalency suggested but not required.

EMT238 2 credits 2 periods

Vehicular Extrication and Patient Stabilization (FSC238)

Participative course designed for the Emergency Medical Technicians (EMT). Incorporates new knowledge and skills necessary to access, extricate and care for victims of crash incidents. Provides exposure to scene management, including size-up, disentanglement, victim stabilization for single and multi-victim situations, hazardous materials incidents, integration of local emergency medical services (EMS) for patient assessment and management, and standard operating procedures to selected victim scenarios. Prerequisites: Basic EMT Certification, current enrollment in an EMT-Basic program, nurse with emergency department experience, or law enforcement personnel, or permission of instructor.

EMT240 2 credits 2 periods

Advanced Cardiac Life Support

Designed to provide the healthcare professional with comprehensive information to identify emergency cardiovascular care and protocols for the patient in cardiac arrest, post-resuscitative patient management, and core cases in Advanced Cardiac Life Support (ACLS) according to current *Guidelines for Cardiopulmonary Resuscitation and Emergency Cardiovascular Care 2004*. Includes the ACLS approach to cardiovascular emergencies, elements of emergency cardiovascular care, ethical and legal issues, airway assessment and management, ventilation techniques, oxygen therapy, intravenous therapy, analyzing and interpreting the electrocardiogram (ECG), analyzing and interpreting the 12-lead ECG, myocardial ischemia, injury, and infarction, electrical interventions, cardiovascular pharmacology, acute coronary syndromes, emergency cardiovascular care algorithms, acute stroke and transient ischemic attack, and special resuscitation situations. Prerequisites: Current validation in Basic Life Support (BLS) Health Care Provider/Professional Rescuer, and (EMT235 and EMT236, or permission of instructor).

EMT241 0.5 credit 0.5 period

Advanced Cardiac Life Support Refresher

Designed to provide the healthcare professional with a review and updated information in emergency cardiovascular care and protocols for the patient in cardiac arrest, post-resuscitative patient management, and core cases in Advanced Cardiac Life Support (ACLS) according to current *Guidelines for Cardiopulmonary Resuscitation and Emergency Cardiovascular Care 2004*. Includes the ACLS approach to cardiovascular emergencies, elements of emergency cardiovascular care, ethical and legal issues, review and validation of the techniques of airway assessment and management, ventilation techniques, oxygen therapy, intravenous therapy, analyzing and interpreting the electrocardiogram (ECG), analyzing and interpreting the 12-lead ECG, myocardial ischemia, injury, and infarction, electrical interventions, cardiovascular pharmacology, acute coronary syndromes,

emergency cardiovascular care algorithms, acute stroke and transient ischemic attack, and special resuscitation situations. Prerequisites: (Current validation in Basic Life Support (BLS) Health Care Provider/Professional Rescuer or EMT240) or permission of instructor.

EMT242 1 credit 1 period

Pediatric Advanced Life Support

Didactic and psychomotor skill education and training in techniques of Pediatric Advanced Life Support. Includes endotracheal intubation, defibrillation, arrhythmia recognition, pharmacology, and intraosseous infusion. Required for American Heart Association Provider approval and validation. Prerequisites: (Current validation in Basic Life Support (BLS) Health Care Provider/Professional Rescuer or [EMT235 and EMT236]) or permission of instructor.

EMT243 0.5 credit 1.5 periods

Pediatric Advanced Life Support Refresher

Current American Red Cross or American Heart Association Health Care Provider validation. Current validation in Pediatric Advanced Life Support. Prerequisites: EMT242, or permission of instructor.

EMT245 2 credits 3.5 periods

Trauma Management I

Designed to instruct prehospital care personnel in the critical skills necessary to manage the trauma victim and the emergency scene through the Incident Command System (ICS). Enhances basic emergency medical technology (EMT) skills by focusing on emergency care interventions. Provides exposure to victim assessment, initial treatment, resuscitative techniques, victim stabilization, transportation of the victim to an emergency care facility, and documentation. Prerequisites: Basic EMT certification or nurse with emergency room experience, or permission of department.

EMT246 4 credits 4 periods

Trauma Management II

Designed to instruct advanced prehospital care personnel in the critical skills necessary to manage the trauma victim and the emergency scene through the Incident Command System (ICS). Enhances advanced emergency medical technology (EMT) skills by focusing on emergency care interventions. Provides advanced exposure to victim assessment, initial treatment, resuscitative skills, invasive techniques, electrical and pharmacologic interventions, stabilization, transportation of the victim to an emergency care facility, and documentation. Prerequisites: Certified as a Basic EMT, Intermediate EMT, Paramedic, or Arizona registered prehospital nurse, or permission of instructor.

EMT272AA 12.5 credits 17.37 periods

Advanced Emergency Medical Technology

Designed to provide the emergency medical technician with advanced knowledge about the acute critical differences in physiology, pathophysiology, and clinical symptoms, as they pertain to prehospital emergency care. Emphasis on developing diagnostic and advanced emergency treatment skills necessary to care for the acutely ill and seriously injured. Prerequisites: Prerequisites: ([MAT102 or equivalent, or a satisfactory score on an applicable district placement exam], ENG101, EMT235, and EMT236), or permission of Program Director. Comprehensive written, oral and practical evaluation on all EMT272AA. Prerequisite courses required and valid Arizona certification and employment as an EMT for one full calendar year. *Corequisites: EMT272AB and EMT272LL.*

Course Descriptions

EMT272AB 12.5 credits 17.38 periods

Advanced Emergency Medical Technology

Designed to provide the emergency medical technician with advanced knowledge about the acute critical differences in physiology, pathophysiology, and clinical symptoms, as they pertain to prehospital emergency care. Emphasis on developing diagnostic and advanced emergency treatment skills necessary to care for the acutely ill and seriously injured. Prerequisites: ([MAT102 or equivalent, or a satisfactory score on an applicable district placement exam], ENG101, EMT235, and EMT236), or permission of Program Director. Comprehensive written, oral and practical evaluation on all EMT272AB. Prerequisite courses required and valid Arizona certification and employment as an EMT for one full calendar year. *Corequisites: EMT272AA and EMT272LL.*

EMT272LL 7.5 credits 37.5 periods

Advanced Emergency Medical Technology Practicum

Clinical and vehicular practicum in support of EMT272AA and EMT272AB. *Prerequisites or Corequisites: EMT272AA and EMT272AB.*

EMT273AA 0.75 credit 0.75 period

Advanced Life Support Refresher Course: Part I

Designed to meet requirements for EMT-Intermediate and EMT-Paramedic under guidelines of the U.S. Department of Transportation (U.S. DOT), National Registry of EMTs (NREMT) as recognized by the Arizona Department of Health Services (A-DHS) Bureau of Emergency Services (B-EMS). Provides updated knowledge and skills related to communication, medical legal issues, health/safety issues pertaining to pre-hospital care, and assessment and treatment of the trauma victim. Validates requisite knowledge, validates skills, reviews and informs students of new standards and technologies. Trains and educates out-of-state applicants in knowledge, procedures, medications, and skills specific to Arizona's system. Remediate students who have been unsuccessful three times on the certification examinations, and refreshes information for those who have expired certifications and desire re-entry into the EMS system. Prerequisites: (EMT - Advanced Paramedic certification or EMT - Intermediate certification or proof of current paramedic registry with the National Registry of Emergency Medical Technicians[NREMT]) or permission of instructor.

EMT273AB 1 credit 1.25 periods

Advanced Life Support Refresher Course: Part II

Designed to meet requirements for EMT-Intermediate and EMT-Paramedic under guidelines of the U.S. Department of Transportation (U.S. DOT), National Registry of EMTs (NREMT) as recognized by the Arizona Department of Health Services (A-DHS) Bureau of Emergency Services (B-EMS). Provides updated knowledge and skills related to airway assessment and treatment, including all Basic Life Support (BLS) and Advanced Life Support (ALS) level skills, pharmacology, and assessment and treatment of the cardiac patient. Validates requisite knowledge, validates skills, reviews and informs students of new standards and technologies. Trains and educates out-of-state applicants in knowledge, procedures, medications, and skills specific to Arizona's system. Remediate students who have been unsuccessful three times on the certification examinations, and refreshes information for those who have expired certifications and desire re-entry into the EMS system. Prerequisites: (EMT - Advanced Paramedic certification or EMT - Intermediate certification or proof of current paramedic registry with the National Registry of Emergency Medical Technicians[NREMT]) or permission of instructor.

EMT273AC 0.75 credit 0.75 period

Advanced Life Support Refresher Course: Part III

Designed to meet requirements for EMT-Intermediate and EMT-Paramedic under guidelines of the U.S. Department of Transportation (U.S. DOT), National Registry of EMTs (NREMT) as recognized by the Arizona Department of Health Services (A-DHS) Bureau of Emergency Services (B-EMS). Provides updated knowledge and skills related to the assessment and treatment of the medical patient. Validates requisite knowledge, validates skills, reviews and informs students of new standards and technologies. Trains and educates out-of-state applicants in knowledge, procedures, medications, and skills specific to Arizona's system. Remediate students who have been unsuccessful three times on the certification examinations, and refreshes information for those who have expired certifications and desire re-entry into the EMS system. Prerequisites: (EMT - Advanced Paramedic certification or EMT - Intermediate certification or proof of current paramedic registry with the National Registry of Emergency Medical Technicians[NREMT]) or permission of instructor.

EMT273AD 1 credit 1.25 periods

Advanced Life Support Refresher Course: Part IV

Designed to meet requirements for EMT-Intermediate and EMT-Paramedic under guidelines of the U.S. Department of Transportation (U.S. DOT), National Registry of EMTs (NREMT) as recognized by the Arizona Department of Health Services (A-DHS) Bureau of Emergency Services (B-EMS). Provides updated knowledge and skills related to the assessment and treatment of the neonatal and pediatric patient. Validates requisite knowledge, validates skills, reviews and informs students of new standards and technologies. Trains and educates out-of-state applicants in knowledge, procedures, medications, and skills specific to Arizona's system. Remediate students who have been unsuccessful three times on the certification examinations, and refreshes information for those who have expired certifications and desire re-entry into the EMS system. Prerequisites: (EMT - Advanced Paramedic certification or EMT - Intermediate certification or proof of current paramedic registry with the National Registry of Emergency Medical Technicians[NREMT]) or permission of instructor.

ENGINEERING SCIENCE

ECE

Physical Science Department Office PS 153 (480) 423-6111
ECE Course Coordinator, Dr. Kyle Rawlings .. PS 151 (480) 423-6166

ECE101 3 credits 3 periods

Origins of Science and Engineering

Introduction to the profession of engineering from a historical perspective. Evolution of engineering from its ancient roots in China, Europe and the Mideast to the development of engineering during the Renaissance and the 18th and 19th centuries in Europe and the growth of engineering in the United States from its French and British roots to current day practices. Includes electronic research methods. Prerequisites: None.

ECE102 2 credits 4 periods

Engineering Analysis Tools and Techniques

Learning culture of engineering, engineering use of computer tools, and computer modeling as applied to engineering analysis and design. Prerequisites: Two years of high school algebra or MAT122 or departmental approval. Corequisites: MAT151 or MAT182 or MAT187.

Course Descriptions

ECE103 2 credits 4 periods
Engineering Problem Solving and Design
 Fundamentals of the design process: engineering modeling, communication and problem-solving skills in a team environment. Emphasis on process-based improvements to the design process. Introduction to engineering science as a profession. Prerequisites: ECE102 and (high school physics or PHY111).

ECE201 4 credits 6 periods
Electrical Network I
 Introduction to electrical networks. Component models, transient and steady state analysis. Prerequisites: ECE103. Prerequisites or Corequisites: MAT262, and (PHY115 and PHY116), or (PHY121 and PHY131).

ECE211 3 credits 5 periods
Engineering Mechanics - Statics
 Mathematical treatment of the basic physical principles of statics. Methods of vector algebra and vector calculus. Prerequisites: ECE103, (MAT230 or MAT231), and (PHY115 or PHY121). Corequisites: MAT241.

ECE212 3 credits 5 periods
Engineering Mechanics - Dynamics
 Kinematics and kinetics of particles, translating and rotating coordinate systems, rigid body kinematics, dynamics of systems of particles and rigid bodies, and energy and momentum principles. Prerequisites: ECE211 and MAT241.

ECE298 - SPECIAL PROJECTS: Information about ECE298 courses can be found on page 203.

ENGLISH ENG

Language/Communication Division LC 305 (480) 423-6459

ENG061 3 credits 3 periods
Basic Writing Skills
 Emphasis on preparation for college-level composition with a focus on foundational skills. Establishing effective writing strategies through six or more writing projects comprising at least 1,500 words in total. Prerequisites: Appropriate English placement test score, or permission of department/division chair.

ENG071 3 credits 3 periods
Fundamentals of Writing
 Emphasis on preparation for college-level composition with a focus on organizational skills. Developing effective writing strategies through five or more writing projects comprising at least 2,000 words in total. Prerequisites: Appropriate English placement test score, or permission of department/division chair.

ENG100AC 1 credit 1 period
The Mechanics of Written English
 Review of the mechanics of written English, including punctuation, arbitrary marks and usages, capitalization, agreement, tense, and sentence patterns. Prerequisites: Appropriate English placement test score, or a grade of C or better in ESL040, or (ESL040AA, ESL040AB and ESL040AC), or ENG071, or permission of instructor.

ENG101 3 credits 3 periods
First-Year Composition
 Emphasis on rhetoric and composition with a focus on expository writing and understanding writing as a process. Establishing effective college-level writing strategies through four or more writing projects comprising at least 3,000 words in total. Prerequisites: Appropriate English placement test score or (a grade of C or better in ENG071).

ENG102 3 credits 3 periods
First-Year Composition
 Emphasis on rhetoric and composition with a focus on persuasive, research-based writing and understanding writing as a process. Developing advanced college-level writing strategies through three or more writing projects comprising at least 4,000 words in total. Prerequisites: ENG101 with a grade of C or better.

ENG200 3 credits 3 periods
Reading and Writing About Literature
 Emphasis on critical analysis of various genres of literature; includes study of necessary terminology, introduction to methods of literary criticism, and practice in interpretation and evaluation. Prerequisites: ENG102.

ENG210 3 credits 3 periods
Creative Writing
 Skills and techniques used in the production of marketable materials for contemporary publications that buy prose fiction, poetry, and expository articles. May be repeated for a total of six (6) credit hours with departmental approval. Prerequisites: ENG102 with a grade of C or better, or permission of department.

ENG213 3 credits 3 periods
Introduction to the Study of Language
 Study of language as code; phonetics, phonology, morphology, syntax, semantics; language acquisition; historical and socio-linguistics. Prerequisites: ENG102 or ENG111 with a grade of C or better, or permission of instructor.

ENG217 3 credits 3 periods
Personal and Exploratory Writing
 Using writing to explore one's self and the world one lives in; emphasis on journal writing as a source and inspiration for public writing. Prerequisites: ENG101 or ENG107 or equivalent.

ENG235 3 credits 3 periods
Magazine Article Writing
 Basic skills and techniques used by professional writers for publication in magazines. Includes analyzing markets, identifying article slant, writing query letters, research techniques, editing, and submission procedures. Emphasis on nonfiction. Prerequisites: None.

Course Descriptions

ENGLISH AS A SECOND LANGUAGE

ESL

Language/Communication Division LC 305 (480) 423-6459

ESL Course Sequence Block Schedule

Basic - Level I:

CELSA score: 0 - 7

ESL001 Basic English as a Second Language I
RDG008 Phonics



Basic - Level II:

CELSA score: 8 - 15

ESL002 Basic English as a Second Language II
RDG008 Phonics



Level I:

CELSA score: 16 - 29

ESL010 Grammar	ESL014 Idiomatic English
ESL011 Listening & Speaking	RDG010 Reading
ESL012 Writing	



Level II:

CELSA score: 30 - 38

ESL020 Grammar	ESL024 Idiomatic English
ESL021 Listening & Speaking	RDG020 Reading
ESL022 Writing	



Level III:

CELSA score: 39 - 50

ESL030 Grammar	ESL034 Idiomatic English
ESL031 Listening & Speaking	RDG030 Reading
ESL032 Writing	



Level IV:

CELSA score: 51 - 66

ESL040 Grammar	ESL044 Idiomatic English
ESL041 Listening & Speaking	RDG040 Reading
ESL042 Writing	



Transitional ESL classes:

CELSA score: 67 - 75 Take ASSET Test for placement

CRE101 Critical/Evaluative Reading	ESL077 Fundamentals of Writing
ESL051 Pronunciation Improvement	ENG107 First-Year Composition
ESL054 American Culture	ENG108 First-Year Composition
ESL067 Basic Writing Skills	ENG109 Business Writing

TOEFL Preparation

Designed to help students prepare for the computer-based TOEFL tests. Includes pre- and post-tests, and the study of test-taking strategies. Offered as a non-credit course. For more information, contact John Liffiton, ESL Coordinator, at (480) 423-6447 or by email at john.liffiton@sccmail.maricopa.edu.

ESL

English as a Second Language

ESL001AA 1 credit 1 period

Basic ESL I: Personal Health

Listening, speaking, reading and writing in English at a basic level. Focus on survival skills related to personal health when living in the United States. Introduction to elementary grammatical patterns. Prerequisites: None. *Course Note: Credit (P) or no credit (Z). Standard grading available according to procedures outlined in catalog. May be repeated for a total of two (2) credits.*

ESL001AB 1 credit 1 period

Basic ESL I: Safety

Listening, speaking, reading and writing in English at a basic level. Focus on survival skills related to personal safety when living in the United States. Introduction to elementary grammatical patterns. Prerequisites: ESL001AA, or permission of instructor. *Course Note: Credit (P) or no credit (Z). Standard grading available according to procedures outlined in catalog. May be repeated for a total of two (2) credits.*

ESL001AC 1 credit 1 period

Basic ESL I: Services

Listening, speaking, reading and writing in English at a basic level. Focus on survival skills related to services when living in the United States. Introduction to elementary grammatical patterns. Prerequisites: ESL001AB or ESL001BA, or permission of instructor. *Course Note: Credit (P) or no credit (Z). Standard grading available according to procedures outlined in catalog. May be repeated for a total of two (2) credits.*

ESL001AD 1 credit 1 period

Basic ESL I: Employment

Listening, speaking, reading and writing in English at a basic level. Focus on survival skills related to employment when living in the United States. Introduction to elementary grammatical patterns. Prerequisites: ESL001AC, or ESL001CA, or permission of instructor. *Course Note: Credit (P) or no credit (Z). Standard grading available according to procedures outlined in catalog. May be repeated for a total of two (2) credits.*

ESL001AE 1 credit 1 period

Basic ESL I: Shopping

Listening, speaking, reading and writing in English at a basic level. Focus on survival skills related to shopping when living in the United States. Introduction to elementary grammatical patterns. Prerequisites: ESL001AD, or ESL001BB, or permission of instructor. *Course Note: Credit (P) or no credit (Z). Standard grading available according to procedures outlined in catalog. May be repeated for a total of two (2) credits.*

ESL001AF 1 credit 1 period

Basic ESL I: Everyday Life

Listening, speaking, reading and writing in English at a basic level. Focus on survival skills related to everyday life when living in the United States. Introduction to elementary grammatical patterns. Prerequisites: ESL001AE, or permission of instructor. *Course Note: Credit (P) or no credit (Z). Standard grading available according to procedures outlined in catalog. May be repeated for a total of two (2) credits.*

Course Descriptions

ESL001BA 2 credits 2 periods
Basic ESL I: Personal Health and Safety
Listening, speaking, reading and writing in English at a basic level. Focus on survival skills related to personal health and safety when living in the United States. Introduction to elementary grammatical patterns. Prerequisites: None. *Course Note: Credit (P) or no credit (Z). Standard grading available according to procedures outlined in catalog. May be repeated for a total of four (4) credits.*

ESL001BB 2 credits 2 periods
Basic ESL I: Services and Employment
Listening, speaking, reading and writing in English at a basic level. Focus on survival skills related to services and employment when living in the United States. Introduction to elementary grammatical patterns. Prerequisites: ESL001BA or permission of instructor. *Course Note: Credit (P) or no credit (Z). Standard grading available according to procedures outlined in catalog. May be repeated for a total of four (4) credits.*

ESL001BC 2 credits 2 periods
Basic ESL I: Shopping and Everyday Life
Listening, speaking, reading and writing in English at a basic level. Focus on survival skills related to shopping and everyday life when living in the United States. Introduction to elementary grammatical patterns. Prerequisites: ESL001BB or permission of instructor. *Course Note: Credit (P) or no credit (Z). Standard grading available according to procedures outlined in catalog. May be repeated for a total of four (4) credits.*

ESL002BA 2 credits 2 periods
Basic ESL II: Personal Health and Safety
Listening, speaking, reading, and writing English at a high beginning level. Focus on survival skills related to personal health and safety when living in the United States. Continuing development of grammatical patterns. Prerequisites: ESL001, or ESL001AF, or ESL001BC, or ESL001CB, or permission of instructor. *Course Note: Credit (P) or no credit (Z). Standard grading available according to procedures outlined in catalog. May be repeated for a total of four (4) credits.*

ESL002BB 2 credits 2 periods
Basic ESL II: Services and Employment
Listening, speaking, reading, and writing English at a high beginning level. Focus on survival skills related to services and employment when living in the United States. Continuing development of grammatical patterns. Prerequisites: ESL002BA or permission of instructor. *Course Note: Credit (P) or no credit (Z). Standard grading available according to procedures outlined in catalog. May be repeated for a total of four (4) credits.*

ESL002BC 2 credits 2 periods
Basic ESL II: Shopping and Everyday Life
Listening, speaking, reading, and writing English at a high beginning level. Focus on survival skills related to shopping and everyday life when living in the United States. Continuing development of grammatical patterns. Prerequisites: ESL002BB or permission of instructor. *Course Note: Credit (P) or no credit (Z). Standard grading available according to procedures outlined in catalog. May be repeated for a total of four (4) credits.*

ESL010 3 credits 3 periods
English as a Second Language I: Grammar
First level of English as a Second Language (ESL). Emphasis on basic conversational skills, pronunciation, vocabulary building and grammar. Some reading and sentence level writing. Credit (P) or no credit (Z). Standard grading available according to procedures outlined in catalog. May be repeated for a maximum of six (6) credits. Prerequisites: Appropriate ESL placement test score.

ESL011 3 credits 3 periods
English as a Second Language I - Listening and Speaking
Emphasis on listening and speaking skills involving survival skills. Asking and answering questions related to work, shopping, and personal safety. May be repeated for a maximum of six (6) credits. Prerequisites: Appropriate ESL placement test score or ESL002.

ESL012 3 credits 3 periods
ESL I - Writing with Oral Practice
Emphasis on basic conventions of writing in English. Includes introduction to the alphabet, capitalization, punctuation, and simple sentence structure. May be repeated for a maximum of six (6) credits. Prerequisites: Approximate ESL placement test score or permission of instructor.

ESL014 1 credit 1 period
Idiomatic English for ESL I
Study of idiomatic English for speakers of English as a Second Language (ESL). Emphasis on commonly misunderstood expressions. Includes practice on a computer or with audio tapes. May be repeated for a maximum of two (2) credits. Prerequisites: Appropriate ESL placement test score or permission of instructor.

ESL020 3 credits 3 periods
English as a Second Language II: Grammar
Second level of English as a Second Language (ESL). Continued emphasis on conversational skills, pronunciation, vocabulary building and grammar with some reading and sentence level writing. Credit (P) or no credit (Z). Standard grading available according to procedures outlined in catalog. May be repeated for a maximum of six (6) credits. Prerequisites: Appropriate ESL placement test score, or a grade of P or C or better in ESL010, or (ESL010AA, ESL010AB, and ESL010AC).

ESL021 3 credits 3 periods
English as a Second Language II - Listening and Speaking
Emphasis on listening and speaking skills involving social exchange. Asking and answering questions, using tag questions. Practice with question and answer patterns. Polite questions and responses. May be repeated for a maximum of six (6) credits. Prerequisites: Appropriate ESL placement test score or ESL010 or ESL011 or ESL012 or RDG010.

ESL022 3 credits 3 periods
ESL II - Writing with Oral Practice
Emphasis on basic writing skills, accompanied by recitation of short writings. Sentence patterns and introduction of paragraph writing. May be repeated for a maximum of six (6) credits. Prerequisites: Appropriate ESL course placement score, or a grade of C or better in ESL012, or permission of instructor.

Course Descriptions

ESL024 1 credit 1 period
Idiomatic English for ESL II
Study of idiomatic English for speakers of English as a Second Language (ESL). Emphasis on commonly misunderstood expressions. Includes practice on a computer or with audio tapes. May be repeated for a maximum of two (2) credits. Prerequisites: Appropriate ESL placement test score or permission of instructor.

ESL030 3 credits 3 periods
English as a Second Language III: Grammar
Third level of English as a Second Language (ESL). Emphasis on sentence structure and paragraph building. Extensive grammar study and writing practice. Credit (P) or no credit (Z). Standard grading available according to procedures outlined in catalog. May be repeated for a maximum of six (6) credits. Prerequisites: Appropriate ESL placement test score, or a grade of P or C or better in ESL020, or (ESL020AA, ESL020AB and ESL020AC).

ESL031 3 credits 3 periods
English as a Second Language III - Listening and Speaking
Emphasis on listening and speaking skills related primarily to the academic environment. Asking questions, working in small groups, using college resources, informal oral presentation. May be repeated for a maximum of six (6) credits. Prerequisites: Appropriate ESL placement test score or ESL020 or ESL021 or ESL022 or RDG020.

ESL032 3 credits 3 periods
ESL III - Writing with Oral Practice
Emphasis on complex sentence patterns in writing and speech. Introduction to the prewriting and writing process in a college setting. May be repeated for a maximum of six (6) credits. Prerequisites: Appropriate ESL course placement score, or a grade of C or better in ESL022, or permission of instructor.

ESL034 1 credit 1 period
Idiomatic English for ESL III
Study of idiomatic English for speakers of English as a Second Language (ESL). Emphasis on commonly misunderstood expressions. Includes practice on a computer or with audio tapes. May be repeated for a maximum of two (2) credits. Prerequisites: Appropriate ESL placement test score or permission of instructor.

ESL040 3 credits 3 periods
English as a Second Language IV: Grammar
Fourth level of English as a Second Language (ESL). Continued emphasis on sentence structure and paragraph building. Extensive grammar study and writing practice. Credit (P) or no credit (Z). Standard grading available according to procedures outlined in catalog. May be repeated for a maximum of six (6) credits. Prerequisites: Appropriate ESL placement test score, or a grade of P or C or better in ENG030, or (ESL030AA, ESL030AB and ESL030AC).

ESL041 3 credits 3 periods
English as a Second Language IV - Listening and Speaking
Emphasis on academic skills. Listening to lectures, note taking, peer interaction, accessing and using media resources, formal oral presentations. May be repeated for a maximum of six (6) credits. Prerequisites: Appropriate ESL placement test score or ESL030 or ESL031 or ESL032 or RDG030.

ESL042 3 credits 3 periods
ESL IV - Writing with Oral Practice
Emphasis on paragraph writing and oral recitation of complex sentences and paragraphs. Introduction to the prewriting and writing process for short essays. May be repeated for a maximum of six (6) credits. Prerequisites: Appropriate ESL course placement score, or a grade of C or better in ESL032, or permission of instructor.

ESL044 1 credit 1 period
Idiomatic English for ESL IV
Study of idiomatic English for speakers of English as a Second Language (ESL). Emphasis on commonly misunderstood expressions. Includes practice on a computer or with audio tapes. May be repeated for a maximum of two (2) credits. Prerequisites: Appropriate ESL placement test score or permission of instructor.

ESL051 3 credits 3 periods
Pronunciation Improvement for ESL Speakers
Individualized pronunciation practice and drills for English as a second language (ESL) speakers. May be repeated for a maximum of six (6) credits. Prerequisites: Appropriate ESL course placement score, or a grade of C or better in (ESL020 or ESL021 or ESL022 or RDG020), or permission of instructor.

ESL054 3 credits 3 periods
American Culture
Reading and writing about American culture including history, institutions and sports, and entertainment. Prerequisites: Appropriate ESL placement test score, or a grade of C or better in ESL040, or (ESL040AA, ESL040AB, and ESL040AC), or RDG040, or permission of instructor.

ESL067 3 credits 3 periods
Basic Writing Skills for English as a Second Language
Emphasis on basic writing skills in sentences and short paragraphs using correct, clear, and idiomatic English. Prerequisites: Appropriate English or ESL placement score, or ESL040, or ESL042, or permission of department chair.

ESL077 3 credits 3 periods
Fundamentals of Writing English as a Second Language
Emphasis on writing paragraphs and short essays using correct, idiomatic English. Prerequisites: Appropriate English or ESL placement score, or ESL040, or ENG056, or ENG061, or ESL042, or permission of department chair.

Course Descriptions



ENG107 **3 credits** **3 periods**
First-Year Composition for ESL

Equivalent of ENG101 for students of English as a Second Language (ESL). Standard American English writing skills and emphasis on expository composition. Prerequisites: Appropriate ASSET/COMPASS placement test score, or a grade of C or better in ENG071 or ESL077. *Course Note: Taking ESL040 and ESL042 may build skills tested by the ASSET/COMPASS placement.*

ENG108 **3 credits** **3 periods**
First-Year Composition for ESL

Equivalent of ENG102 for students of English as a Second Language. Continued development of standard English writing skills. Introduction to research, note taking, organization and documentation in the preparation and writing of a research paper. Not open to students who have completed ENG101. Prerequisites: Grade of C or better in ENG107.

ENG109 **3 credits** **3 periods**
Business Writing for ESL

ESL focus: Writing business letters and memos with an emphasis on persuasion and organization. Prerequisites: Appropriate ESL or ASSET placement test score, or a grade of C or better in (ENG107, or ENG108, or ENG101, or ENG102, or ENG111), or permission of instructor.

RDG Reading English as a Second Language

RDG010 **3 credits** **3 periods**
Reading English as a Second Language I

Designed for students who are learning English as a second language. Provides students with skills needed to become proficient readers in English. Teaches sound symbol relationships of the English alphabet. Expands essential vocabulary for daily communication both in isolation and context. Includes development of reading comprehension skills. Prerequisites: Appropriate ESL placement test score.

RDG020 **3 credits** **3 periods**
Reading English as a Second Language II

Designed for students who are learning English as a second language. Includes continued development of vocabulary and reading comprehension skills. Prerequisites: Appropriate ESL placement test score, or grade of C or better in RDG010, or permission of instructor.

RDG030 **3 credits** **3 periods**
Reading English as a Second Language III

Designed for students who are learning English as a second language. Includes instruction for more advanced vocabulary and reading comprehension skills. Prerequisites: Appropriate ESL placement test score, or grade of C or better in RDG020, or permission of instructor.

RDG040 **3 credits** **3 periods**
Reading English as a Second Language IV

Developed for students of English as a second language. Includes development of advanced vocabulary, comprehension skills, and culture awareness. Prerequisites: Appropriate ESL placement test score, or grade of C or better in RDG030, or permission of instructor.

ENGLISH HUMANITIES

ENH

Language/Communication Division LC 305 (480) 423-6459

ENH110 **3 credits** **3 periods**
Introduction to Literature

Introduction to international literature through various forms of literary expression, e.g., poetry, drama, essay, biography, autobiography, short story, and novel. Provides a global overview of literature with special emphasis on diverse cultural contributions of women, African Americans, Asian Americans, Hispanic Americans, and Native Americans. Prerequisites: None.

ENH120 **3 credits** **3 periods**
The Literature of Science Fiction

Surveys the last two hundred years of Science Fiction literature and various other media. Investigates the similarities between Science Fiction and other imaginative literatures and media. Examines the Science Fiction genre, sub genres, and themes from a variety of perspectives, as well as social issues. Prerequisites: None.

ENH130 **3 credits** **3 periods**
American Detective Fiction

A study of American detective fiction as a literary genre and as a reflection of American culture through the writings of significant authors. Prerequisites: None.

Course Descriptions

ENH201 3 credits 3 periods
World Literature Through the Renaissance
Includes a selection of the world's literary masterpieces in their cultural background, beginning with ancient Oriental and Occidental writings and concluding with Renaissance writings. Prerequisites: None.

ENH202 3 credits 3 periods
World Literature After the Renaissance
Includes a selection of the world's literary masterpieces from the Renaissance to modern times. Prerequisites: None.

ENH221 3 credits 3 periods
Survey of English Literature Before 1800
Emphasizes the social and political backgrounds as well as the form and content of English literature from Anglo-Saxon times to the end of the eighteenth century. Prerequisites: None.

ENH222 3 credits 3 periods
Survey of English Literature After 1800
Emphasizes the social and political backgrounds as well as the form and content of English literature in the nineteenth and twentieth centuries. Prerequisites: None.

ENH230 3 credits 3 periods
Introduction to Shakespeare
Introduces Shakespeare the playwright, the sonneteer, the linguist, and the citizen of the 17th century. Considers the major tragedies, comedies, histories, and sonnets; focuses on the use of language; and connects the writer to the time. Some emphasis on Shakespeare's influence through the centuries, noting parallels between the late 16th century and the late 20th century. Prerequisites: None.

ENH231 3 credits 3 periods
Introduction to Shakespeare: The Early Plays
Introduces Shakespeare, the playwright and linguist, and the late 16th century. Considers representative comedies, histories, and tragedies from Shakespeare's early period, from 1590-1599. Focuses on the use of language and connects the writer to his historical era. Also considers Shakespeare's relevance to our own time. Prerequisites: None. *Course Note: Student may receive credit for only one of the following: ENH230 or ENH231.*

ENH232 3 credits 3 periods
Introduction to Shakespeare: The Late Plays
Introduces Shakespeare, the playwright and linguist, and the early 17th century. Considers representative comedies, histories, tragedies, and romances from Shakespeare's late period, from 1600-1611. Focuses on the use of language and connects the writer to his historical era. Also considers Shakespeare's relevance to our own time. Prerequisites: None. *Course Note: Student may receive credit for only one of the following: ENH230 or ENH232.*

ENH241 3 credits 3 periods
American Literature Before 1860
Includes literature written prior to 1860 in the United States. Prerequisites: None.

ENH242 3 credits 3 periods
American Literature After 1860
Includes literature written after 1860 in the United States. Prerequisites: None.

ENH250 3 credits 3 periods
Classical Backgrounds in Literature
Introduction to selected readings of Greek and Latin literature in translation and to the key elements as integral aspects of Western culture through successive ages. Prerequisites: None.

ENH251 3 credits 3 periods
Mythology
Deals with the myths and legends of civilizations with the greatest influence upon the development of the literature and culture of the English speaking people, and compares those myths with myths from other cultures. Prerequisites: None.

ENH254 3 credits 3 periods
Literature and Film
Presents works of literature and their film versions and analyzes distinguishing techniques of each medium. Prerequisites: ENG101, or ENG107, or equivalent.

ENH256 3 credits 3 periods
Shakespeare on Film
Presents cinematic versions of Shakespeare's plays and explains and analyzes how the dramatist's major tragedies, comedies, histories and romances have been presented on film. Prerequisites: None.

ENH260 3 credits 3 periods
Literature of the Southwest
Investigates major themes in Southwestern American literature including the Western myth, minority roles in the region's literature, control of nature versus primacy of nature, and growth. Both prose and poetry are examined with an emphasis on contemporary Southwestern writing. Prerequisites: None.

ENH275 3 credits 3 periods
Modern Fiction
Includes novels and short stories of modern writers which reflect significant themes of our time. Prerequisites: None.

ENH285 3 credits 3 periods
Contemporary Women Writers (WST285)
Explores twentieth century literature (short stories, essays, plays, and poetry) written by women and about women. Focus on themes relevant to women's lives regardless of age, creed, or ethnic background. Prerequisites: None.

Course Descriptions

ENH290 3 credits 3 periods
Modern Irish Literature and Culture
 Literature of Ireland from 1880 to the present. Examines how uniquely Irish themes have been reflected in high and popular culture and how these cultures and themes have influenced Ireland's literary tradition. Prerequisites: None.

ENH291 3 credits 3 periods
Children's Literature (EDU291)
 Review of folk and modern literature from a variety of world cultures, including application of literary criteria to folk and modern literature for children. Prerequisites: None.

ENH292 3 credits 3 periods
Literature for Adolescents
 Reviews selected literature written for adolescents. Develops and applies literary criteria for the evaluation of adolescent literature. Prerequisites: None.

ENH294 3 credits 3 periods
Multicultural Folktales (EDU294, STO294)
 Study of multicultural folktales, exploring the impact of the oral tradition in American society and showing classroom applications. Prerequisites: None.

ENTREPRENEURIAL STUDIES EPS

Business Division Office AP 237A (480) 423-6253

EPS101 2 credits 2 periods
Rich Dad's CASHFLOW® Instructor Training
 Rich Dad's Cashflow principles, processes, and tools that represent a new paradigm for financial literacy. Concepts and principles based upon Rich Dad Poor Dad, Cashflow Quadrant, and the Rich Dad Cashflow 101 game (Copyright) (all). Prerequisites: None.

EPS102 2 credits 2 periods
Rich Dad's CASHFLOW®
 Principles, processes, and tools that represent a new paradigm for financial literacy. Concepts and principles based upon Rich Dad Poor Dad, Cashflow Quadrant, and the Rich Dad Cashflow 101 game (Copyright). Prerequisites: None.



SCC Business Institute

EQUINE SCIENCE EQS

Applied Sciences Division Office AP 237B (480) 423-6599

EQS105 3 credits 3 periods
Principles of Equine Science
 Breeds, colors and markings; horse selection; basic conformation; form to function; structures of the hoof; footfall sequences; vision, managed health program; nutrition principles and management practices. Prerequisites: None.

EQS120 3 credits 3 periods
Equine Anatomy and Physiology
 Study of structure and function of the equine. Includes cell structure and anatomy and physiology of major systems with emphasis on skeletal, muscular, and digestive systems. Prerequisites: None.

EQS130 3 credits 3 periods
Equine Business and Law
 Practices and records used in the equine business. Includes record keeping systems and basic accounting principles; taxes; personnel management practices; computer programs for record keeping and operations management. Addresses legal aspects and laws unique to equine businesses. Prerequisites: None.

EQS140 3 credits 3 periods
Equine Behavior
 Equine behavior modification using the horse's natural behavior patterns. Emphasis on intelligence level, vision, emotions, hearing, and attention span of the horse. Prerequisites: None.

EQS160 3 credits 3 periods
English Horsemanship I
 Basic ground work and safety procedures; control of the horse at the walk, trot, and canter; rider position and use of fundamental aids. Prerequisites: None.

EQS165 3 credits 3 periods
Western Horsemanship I
 Basic ground work and safety procedures; control of the horse at the walk, jog, and lope; rider position and use of fundamental aids. Prerequisites: None.

EQS175 3 credits 4 periods
Introduction to Equine Massage
 Designed to acquaint students with the major muscle groups of the horse and the relationship that exists between the muscular system and equine locomotion. Instruction and practice in basic equine massage techniques designed to aid muscle relaxation. Course is not designed to train or certify individuals to massage horses on a professional basis. Prerequisites: None.

EQS180 3 credits 3 periods
English Horsemanship II
 Increase control, balance, form and finesse in the balanced seat style of English riding. Emphasis on developing the rider's ability to apply precise, prompt, smooth aids, and attain harmony with the horse through use of body language. Prerequisites: EQS160 or department approval.

Course Descriptions

EQS185 3 credits 3 periods
Western Horsemanship II
Refinement of basic riding skills; weight, leg, and rein aids; gathering and checking; two-track; trail obstacles; simple change of lead; elements of a Western riding pattern. Prerequisites: EQS165 or department approval.

EQS200 3 credits 3 periods
Principles of Equine Nutrition
Basic principles of equine nutrition and digestion. Proper selection, evaluation, and utilization of feeds. Emphasis on nutrient content and ration evaluation, general health and feed management. Prerequisites: EQS105 and EQS120, or permission of department.

EQS215 3 credits 3 periods
Feeding Programs for Production and Performance
Explores the feeding and care of the equine in various stages of production, growth and performance. Identifies specific nutritional needs of each class of equine and formulates feeding programs based on these specific needs. Prerequisites: EQS200 or permission of department.

EQS220 3 credits 3 periods
Equine Reproduction
Reproductive anatomy and physiology; care and management of the breeding stallion; breeding procedures and artificial insemination. Care of pregnant mare; foaling procedures. Prerequisites: (EQS105 and EQS120) or permission of department.

EQS225 3 credits 3 periods
Equine Health and Disease Management
Aspects of equine health and disease prevention. Emphasis on preventive maintenance. Preventive medicine and necessary managerial practices needed to keep the equine athlete, broodmare, or family horse in good health. Prerequisites: (EQS105 and EQS120) or department approval.

EQS250 3 credits 6 periods
Equine Evaluation
Fundamental relationship between good conformation and ability of the horse to remain sound and useful. Includes basic skeletal structure, common blemishes and unsoundness, breed standards, and performance events for the American Quarter Horse, Arabian, Thoroughbred, Morgan, American Saddlebred, and National Show Horse. Prerequisites: EQS105 and EQS120, or department approval.

EQS280 2 credits 10 periods
Equine Science Internship
Equine industry work experience in the area of choice. May include any type of departmentally approved equine facility or equine-related business. Prerequisites: Completion of all 100-level EQS courses and EQS250.

EQS282 1 credit 5 periods
Special Event Internship
Hands-on career track experience before, during and after a major equine event. Emphasis on event coordination and management issues. May be repeated for a total of four (4) credits with department permission. Prerequisites: Enrollment in the Equine Science program.

FAMILY AND CONSUMER SCIENCE FCS

Social/Behavioral Sciences Division SB 130 (480) 423-6206

ALSO SEE: Child/Family Studies (CFS), page 134
Early Childhood Development (ECH), page 150
Early Education (EED), page 151
Infant/Toddler Development (ITD), page 175

FCS250 3 credits 3 periods
Portfolio Development and Professional Writing
Techniques of portfolio development to document prior learning gained through experience, training, and/or previous education. Includes study of learning styles and levels, analysis of personal and vocational experiences, synthesis of these with competencies for specific courses, and integration of the above with other material to create a portfolio to be introduced for evaluation for credit. Prerequisites: Completion of twelve (12) credit hours of CFS and/or FCS coursework and permission of Program Coordinator.

FCS260 1 credit 1 period
Family and Consumer Science Internship
Work experience in community-based, family-focused service and/or educational organizations. 80 hours of designated work per credit. Prerequisites: Permission of instructor.

FIRE SCIENCE TECHNOLOGY FSC

Health Sciences Division Office SB 132 (480) 423-6225

FSC102 11 credits 19.6 periods
Fire Department Operations
Introductory fire science course primarily designed for the fire department recruit. Includes fire fighting skills, equipment, and administrative policies, fire department operations, personnel policies, and International Fire Service Accreditation Congress Practical Skills Testing. Prerequisites: (EMT104, FSC105 and FSC130) and permission of instructor. Corequisites: FSC134.

FSC104 8 credits 9.45 periods
Basic Emergency Medical Technology (EMT104)
Techniques of emergency medical care in accordance with national and state curriculum. Study of the human body, patient assessment, treatment of medically or traumatically compromised patients, special hazards, and medical operations. IV monitoring, Sudden Infant Death Syndrome (SIDS), patient-assisted medication administration, automated external defibrillators, and blood-glucose monitoring. Includes participation in two eight-hour clinical rotations through a local emergency department scheduled during the semester outside normal class hours. Requires personal pocket mask, stethoscope, pen light, and trauma scissors. Prerequisites: Must be at least 18 years of age prior to applying to the BLS (Basic Life Support) Training Program per Arizona Revised Statutes, and must have a validation in Basic Life Support (BLS) Health Care Provider/Professional Rescuer. Minimum ninth grade level reading proficiency on the Nelson-Denney Examination or appropriate Reading course placement score. Proof of: TB testing or chest x-ray with a negative result within six (6) months prior to registration; immunity to rubella (German Measles) and rubeola.

Course Descriptions

FSC105 3 credits 3 periods
Hazardous Materials/First Responder

Basic methods of recognition and identification based upon the chemical and physical properties of hazardous materials; basic safety procedures when utilizing specific types of protective clothing and equipment; basic tactical information relating to scene management. Confined space operations in accordance with the National Fire Protection Agency. Prerequisites: None.

FSC106 3 credits 3 periods
Introduction to Fire Protection

History and evaluation of fire department organization. Role of the fire service in the community. Responsibilities of the fire administrator including organization, departmental functions, interdepartmental relationships, management of buildings and equipment; techniques of fire fighting. Also includes emergency medical services and fire prevention. Prerequisites: None.

FSC108 3 credits 3 periods
Fundamentals of Fire Prevention

Fundamentals of fire prevention. Includes techniques, procedures, regulations, and enforcement. Also includes discussion of hazards in ordinary and special occupancies. Field trips and lectures from industry also included. Prerequisites: None.

FSC110 2 credits 2 periods
Wildland Firefighter

Basic-level course for individuals with little or no experience in the wildland environment. Preparation for performing as a beginning-level wildland firefighter with an organized fire department engine or hand crew. Prerequisites: None.

FSC113 3 credits 3 periods
Introduction to Fire Suppression

Characteristics and behavior of fire, fire hazard properties of ordinary materials, extinguishing agents, fire suppression organization and equipment, basic fire fighting tactics, and public relations as affected by fire suppression. Prerequisites: None.

FSC117 3 credits 3 periods
Fire Apparatus

Principles of care, maintenance and operation of fire apparatus and pumps. Includes pump construction and accessories, pumping techniques, power development, and transmission. Driving, troubleshooting and producing effective fire streams. Prerequisites: None.

FSC118 3 credits 3 periods
Fire Hydraulics

Review of basic mathematics. Hydraulic laws and formulas as applied to the fire service. Application of formulas and mental calculations to hydraulic problems, water supply variables, and discharge requirements for pumps. Prerequisites: None.

FSC134 3 credits 4.6 periods
Fitness and Conditioning for Firefighters

Overview of all aspects of fitness for current and prospective firefighters. Includes physical and mental aspects of performance for optimal achievement on fire department agility tests and fire fighting tasks; individual conditioning strategies, nutritional guidelines, protective clothing concepts, and basic exercise principles. Pre-employment, evaluation, and lifelong fitness and conditioning. Prerequisites: None.

FSC139 3 credits 3 periods
Emergency Response to Terrorism (AJS139)

Fundamentals of emergency response to suspected terrorist events. Historical perspective of terrorist activities and methods by which responders can identify and protect themselves and the public from these threats. Coordination of responding agencies. Prerequisites: None.

FSC204 3 credits 3 periods
Firefighting Tactics and Strategy

Methods of coordinating personnel, equipment, and apparatus on the fireground. Practical methods of controlling and extinguishing structural and other types of fires. Includes simulation exercises. Prerequisites: FSC113, or permission of instructor or equivalent.

FSC208 3 credits 3 periods
Firefighter Safety and Building Construction

Actions necessary to provide for the safety of firefighters operating on the fireground. Effects that fire and heat may have on various types of building construction resulting in the loss of structural integrity. Includes signs and symptoms of structural damage. Prerequisites: FSC113, or permission of instructor, or equivalent.

FSC209 3 credits 3 periods
Fire Investigation

Methods of determining point of fire origin, path of fire travel, and fire cause. Includes recognizing and preserving evidence; interviewing witnesses; arson laws and types of arson fires; and court testimony, reports, and records. Prerequisites: None.

FSC211 3 credits 3 periods
Fundamentals of Flammable Hazardous Materials

Fundamentals of chemistry used in fire service, chemistry of flammable hazardous materials, containers used to store and transport flammable hazardous materials, and equipment and materials used in controlling emergencies involving flammables. Also includes tactics for hazardous materials emergencies, and laws at federal, state and local levels pertaining to the use, storage, and transportation of hazardous materials and hazardous wastes. Prerequisites: FSC105.

FSC212 3 credits 3 periods
Dangerous and Explosive Hazardous Materials

The chemistry of reactive and unstable hazardous materials, the toxicology of dangerous chemicals, and the measures taken to protect responders, the community, and the environment of chemical accidents. Also includes an introduction to field sampling of unknown substances. Prerequisites: FSC211.

Course Descriptions

FSC214 3 credits 3 periods

Human Resource Management in Fire Service

Management of fire service personnel functions. Includes selection procedures, employee discipline, performance ratings, elements of supervision. Labor relations and related personnel responsibilities. Prerequisites: FSC202 or four years in the fire service.

FITNESS AND WELLNESS CENTER

See PHYSICAL EDUCATION (PED), page 195.

FOOD AND NUTRITION FON

Health Sciences Division Office SB 132 (480) 423-6225

FON100 3 credits 3 periods

Introductory Nutrition

Basic nutrition concepts for health and fitness. Emphasizes current dietary recommendations for maximizing well-being and minimizing risk of chronic disease. Focuses on use of tables, food guides, and guidelines for making healthy food choices. Includes unique nutrition needs for selected stages of the life cycle, methods for evaluating credibility of nutrition claims, principles of vegetarian nutrition, safe and economic use of supplements, principles of energy balance, basic elements of food safety, diet for exercise and sports, and personal dietary evaluation techniques. Not for pre-dietetics or selected other preprofessional majors. May not be taken for credit if credit has been earned in FON100AA and/or FON100AC. Prerequisites: None.

FON241 3 credits 3 periods

Principles of Human Nutrition

Scientific principles of human nutrition. Emphasis on health promotion and concepts for conveying accurate nutrition information in a professional setting. Addresses therapeutic nutrition principles for treatment of common health conditions. Includes exploration of food sources of nutrients, basic metabolism of nutrients in the human body, relationship between diet and other lifestyle factors, use of supplements, current recommendations for food selection throughout the life cycle, and use of nutrition tools for planning food intake or assessment of nutritional status. Prerequisites or Corequisites: One year high school chemistry with grade of C or better, or CHM130 and CHM130LL, or approval of instructor.

FOREIGN LANGUAGES

Language/Communication Division LC 305 (480) 423-6459

The foreign language conversation courses (115, 116, 225, 226) qualify as general elective credit. Courses numbered 201 and 202 qualify as a global awareness requirement or for fulfillment of the foreign language requirement at the state universities. Courses numbered 265 and 266 qualify as a global awareness and humanities requirement. These language courses are offered:

- Chinese (CHI) - see page 135
- French (FRE) - see page 167
- German (GER) - see page 170
- Italian (ITA) - see page 177
- Japanese (JPN) - see page 178
- Pima (PIM) - see page 197
- Spanish (SPA) - see page 203

ALSO OFFERED: American Sign Language (SLG), page 200.

FORENSIC SCIENCE FOR

Applied Sciences Division Office AP 237B (480) 423-6599

FOR105 4 credits 6 periods

Forensic Science: Physical Evidence

Scientific analysis and examination of physical evidence for forensic purposes. Covers fingerprints, shoe prints, tool marks, glass, soil and mineral evidence, firearms identification, paint chips, and arson and explosive evidence. Includes the history of forensic science, functions of the crime lab and criminalist career specialties. Prerequisites: None.

FOR223 3 credits 3 periods

Forensic Pathology: Death Investigation (AJS223)

An examination of the medical investigation of sudden, unnatural, unexplained or violent deaths. Explains the legal and medical roles of death investigators and medical examiners. Additional topics include the autopsy, documenting and evaluating the body, routine and special investigative techniques, and death event reconstruction. Prerequisites: None.

FOR245 3 credits 3 periods

Forensic Pathology: Advanced Death Investigation (AJS245)

An advanced examination of the role of the medical examiner in crime scene investigations, mass disasters, motor vehicle accidents, and other unnatural deaths. Covers basic forensic biomechanics, advanced forensic anthropology and the role of the medical examiner as an expert court witness. Prerequisites: AJS223.

FRENCH LANGUAGE FRE

Language/Communication Division LC 305 (480) 423-6459

FRE101AA 4 credits 5 periods

Elementary French I

Basic grammar, pronunciation and vocabulary of the French language. Includes the study of French culture; practice of listening, speaking, reading and writing skills. Prerequisites: None.

FRE102AA 4 credits 5 periods

Elementary French II

Continued study of grammar and vocabulary of the French language along with the study of French culture. Emphasis on speaking, listening, reading and writing skills. Prerequisites: FRE101 or equivalent.

FRE115 3 credits 3 periods

Beginning French Conversation I

Conversational French. Basic sentence structure, pronunciation and vocabulary necessary to develop speaking ability in French. Designed for students seeking speaking and listening abilities with little emphasis on grammar. Prerequisites: None.

FRE116 3 credits 3 periods

Beginning French Conversation II

Continued development of speaking and listening skills for effective communication in French. Prerequisites: FRE115 or equivalent.

Course Descriptions

FRE201 4 credits 4 periods

Intermediate French I

Review of essential grammar of the French language and study of French culture. Continued practice and development of reading, writing, and speaking skills. Prerequisites: FRE102 with a grade of C or better, two years of high school French with an average of C or better, or departmental approval.

FRE202 4 credits 4 periods

Intermediate French II

Review of grammar, continued development of French language skills, and continued study of the French culture. Prerequisites: FRE201 with a grade of C or better, or three years of high school French with an average of C or better.

FRE225 3 credits 3 periods

Intermediate French Conversation I

Continued development of skills in conversational French for business or travel. Prerequisites: FRE116 or departmental approval.

FRE226 3 credits 3 periods

Intermediate French Conversation II

Development of intermediate-level skills in conversational French for business or travel. Prerequisites: FRE225 or departmental approval.

FRE265 3 credits 3 periods

Advanced French I

In-depth exploration of a selected theme related to French culture. Involves reading selections from French literature, writing reports, and discussions in French. Emphasis on enhancing reading, writing and speaking skills. Prerequisites: FRE202 or departmental approval.

FRE266 3 credits 3 periods

Advanced French II

Continuation of FRE265. Reading selections from French literature, written reports, and discussions in French designed to further develop reading, writing and speaking skills. Prerequisites: FRE202 or departmental approval.



GENERAL TECHNOLOGY

GTC

Applied Sciences Division OfficeAP 237B (480) 423-6599

ALSO SEE: Architectural Technology (ARC), page 123
Building Safety Technology (BLT), page 130
Civil Engineering Technology (CET), page 136

GTC124 3 credits 3 periods

Methods and Materials of Construction

Modern methods of construction and materials for residential, multiple, and commercial building, including the four types of structures used: wood, concrete, steel and masonry. Methods of assembly and how different materials can be used to create desired designs. Requirements of most recent building codes and the F.H.A. standards. Prerequisites: None.

GEOGRAPHY

GCU and GPH

Social/Behavioral Sciences Division SB 130 (480) 423-6206

The cultural geography courses (GCU), which provide social/behavioral science credit, are listed first, followed by the physical geography courses (GPH), which provide natural science credit.

GCU

Cultural Geography

GCU102 3 credits 3 periods

Introduction to Human Geography

Systematic study of human use of the earth. Spatial organization of economic, social, political, and perceptual environments. Prerequisites: None.

GCU121 3 credits 3 periods

World Geography I: Eastern Hemisphere

Description and analysis of areal variations in social, economic, and political phenomena in major world regions. Emphasis on Europe, Russia, North Africa, and the Asian world. Prerequisites: None.

GCU122 3 credits 3 periods

World Geography II: Western Hemisphere

Description and analysis of variations in social, economic, and political phenomena in major world regions. Emphasis on Sub-Saharan Africa, Latin America, and Anglo America. Prerequisites: None.

GCU194 3 credits 3 periods

Special Topics in Cultural Geography

Detailed study of specific regions, topics, or current issues in cultural geography. Topics may include origins, diffusion, and division of cultural areas. Examines cultural patterns and spatial organization which may include population, religion, economic, social and political characteristics. Studies interrelationships between humans and the physical environment (i.e. environmental ecosystems, physical processes and natural resources). Prerequisites: None.

GCU221 3 credits 3 periods

Arizona Geography

The historical to modern development of Arizona. The interplay between the physical, cultural and economic factors affecting Arizona today. Prerequisites: None.

Course Descriptions

GPH Physical Geography

GPH111 4 credits 6 periods
Introduction to Physical Geography
Spatial and functional relationships among climates, landforms, soils, water, and plants. Prerequisites: None.

GPH194 3 credits 3 periods
Special Topics in Physical Geography
Detailed study of specific regions, topics, or current issues in physical geography. Emphasis on relationships within and between the atmosphere, lithosphere, hydrosphere, biosphere, and how humans relate to their environment. Topics may include environmental ecosystems, physical processes (i.e., weather, climate, geomorphology, oceanography), natural resources and the impacts of human population (i.e., pollution, politics, religion, economic activities). Field trips may be used as a mandatory component of the course. Prerequisites: None.

GPH210 3 credits 3 periods
Introduction to Environmental Geography
Principles of physical geography relating to environmental problems pertinent to contemporary society. Pollution, maladjusted land use, resource exploitation. Prerequisites: ENG101 or ENG107 or equivalent.

GPH212 3 credits 3 periods
Introduction to Meteorology I
Atmospheric processes and elements. General and local circulation, heat exchange and atmospheric moisture. Prerequisites: None.

GPH214 1 credit 3 periods
Introduction to Meteorology I Lab
Basic meteorological and climatological measurements. Prerequisites: None. Corequisites: GPH212.

GPH213 3 credits 3 periods
Introduction to Climatology
Study of atmospheric phenomena over periods of time measured in months, years or longer. Includes average weather conditions, infrequent and unusual types of weather, and the influence of weather on the cultural and human landscape. Prerequisites: None.

GPH215 1 credit 3 periods
Introduction to Climatology Laboratory
A mathematical, statistical, and spatial analysis of climatological phenomena. Prerequisites: None. Corequisites: GPH213.

GEOLOGY **GLG**

Mathematics/Sciences Division PS 153 (480) 423-6111

The geology curriculum is designed to satisfy the requirements for the first two years of most four-year curricula leading to the preparation of a student to enter such career fields as paleontology, petroleum geology, geological research, geology teacher or other professional geological science careers. The curriculum assumes the student has had a strong science and mathematics background in high school, including a year of chemistry, a year of physics and three years of mathematics. Students who have not had this kind of background should consult a science advisor as to what courses should be taken to strengthen their science and mathematics background before pursuing the geology curriculum. Recommended courses to be taken during the first two years are GLG100 and GLG100LL or GLG101 and GLG103. GLG102 and GLG104 are also recommended. Supporting courses include CHM150/151, CHM152, CHM154, PHY111, PHY112, MAT122 or MAT152. Consultation with the catalog of the college to which the student plans to transfer may recommend a more rigorous math sequence as follows: MAT152, MAT182, MAT220 and MAT230. Since there is some variation in the specific courses required by various universities and colleges, students should consult the catalog of the school to which they will transfer and select courses accordingly.

GLG101 3 credits 3 periods
Introduction to Geology I - Physical Lecture
A study of the kind and arrangement of materials composing the earth's crust and the geological processes at work on and within the earth's surface. Prerequisites: None.

GLG102 3 credits 3 periods
Introduction to Geology II - Historical Lecture
Outlines the origin and history of the earth with emphasis on North America—its dynamic, geographic, and climatic changes; animals and plants of the past; the evolution of life. Prerequisites: None.

GLG103 1 credit 3 periods
Introduction to Geology I - Physical Lab
May accompany GLG101. Study of common rock-forming minerals, rocks, and maps. Prerequisites: None.

GLG104 1 credit 3 periods
Introduction to Geology II - Historical Lab
May accompany GLG102. Study of geological structures and rocks, fossils, and geologic maps. May require field trips. Prerequisites: None.

GLG105 4 credit 6 periods
Introduction to Planetary Science
A survey of solar system objects and their geologic evolution, surfaces, interiors, and atmospheres, and the methods used to study them; weekly laboratory for data analysis and experiments; possible weekend field trip. Prerequisites: None.

GLG110 3 credits 3 periods
Geological Disasters and the Environment
Acquaints students with the use and importance of geological studies as they apply to the interactions between people and the earth. Includes geological processes and hazards such as floods, earthquakes, and landslides; use of fossil fuels; mining of raw materials. Prerequisites: None.

Course Descriptions

GLG111 1 credit 3 periods

Geological Disasters and the Environment Lab

May accompany GLG110. Basic geological processes and concepts. Emphasis on geology-related environmental problems concerning Arizona. Case histories and field studies. May require field trips. Prerequisites: None.

GERMAN LANGUAGE

GER

Language/Communication Division LC 305 (480) 423-6459

GER101AA 4 credits 5 periods

Elementary German I

Basic grammar, pronunciation and vocabulary of the German language. Includes the study of German culture, practice of listening, speaking, reading and writing skills. Prerequisites: None.

GER102AA 4 credits 5 periods

Elementary German II

Continued study of grammar and vocabulary of the German language along with the study of German culture. Emphasis on German language skills. Prerequisites: GER101 or equivalent.

GER115 3 credits 3 periods

Beginning German Conversation I

Conversational German. Basic sentence structure, pronunciation and vocabulary necessary to develop speaking ability in German. Designed for students seeking speaking and listening abilities with little emphasis on grammar. Prerequisites: None.

GER116 3 credits 3 periods

Beginning German Conversation II

Continued development of speaking and listening skills for effective communication in German. Prerequisites: GER115, one year of high school German, or departmental approval.

GER201 4 credits 4 periods

Intermediate German I

Review of essential grammar of the German language and study of the German culture. Continued practice and development of reading, writing and speaking skills. Prerequisites: GER102, two years of high school German, or departmental approval.

GER202 4 credits 4 periods

Intermediate German II

Continued development of German language skills and continued study of the German culture. Prerequisites: GER201 or equivalent or departmental approval.

GER225 3 credits 3 periods

Intermediate German Conversation I

Continued development of skills in conversational German. Prerequisites: One year of German or departmental approval.

GER226 3 credits 3 periods

Intermediate German Conversation II

Further development of skills in conversational German. Prerequisites: One year of college German, GER225, three semesters of high school German or departmental approval.

HEALTH CARE RELATED

HCR

Health Sciences Division Office SB 132 (480) 423-6225

HCR240 4 credits 4 periods

Human Pathophysiology

Chemical, biological, biochemical, and psychological processes as a foundation for the understanding of alterations in health. The structural and functional pathophysiology of alterations in health; selected therapeutics considered. Prerequisites: BIO202 or BIO205 or equivalent.

HCR240AA 2 credits 2 periods

Human Pathophysiology I

Chemical, biological, biochemical, and psychological processes as a foundation for the understanding of alterations in health. The structural and functional pathophysiology of alterations in health; selected therapeutics considered. Prerequisites: BIO202 or BIO205 or equivalent. Corequisites: HCR240AB or permission of instructor.

HCR240AB 2 credits 2 periods

Human Pathophysiology II

Chemical, biological, biochemical, and psychological processes as a foundation for the understanding of alterations in health. The structural and functional pathophysiology of alterations in health; selected therapeutics considered. Prerequisites: BIO202 or BIO205 or equivalent. Corequisites: HCR240AA or permission of instructor.

HEALTH CORE CURRICULUM

HCC

Health Sciences Division Office SB 132 (480) 423-6225

HCC109 0.5 credit 0.5 period

CPR for Health Care Provider (RES109)

Current American Heart Association standards for one and two rescuer cardiopulmonary resuscitation (CPR) and obstructed airway procedures on the adult, infant, and pediatric victim. Use of automated, external defibrillation and resuscitation equipment. Prerequisites: None.

HCC109AA 0.25 credit 0.25 period

CPR for Healthcare Providers Renewal (RES109AA)

Renewal course for Healthcare Provider cardiopulmonary resuscitation (CPR) training. Condensed review of new American Heart Association skills and standards prior to skill testing. Skill testing includes one- and two-rescuer CPR and obstructed airway procedures on the adult, infant, and pediatric victim. Prerequisites: Current Healthcare Provider CPR card at time of course.



Course Descriptions

HISTORY

Social/Behavioral Sciences Division SB 130 (480) 423-6206

HIS100 **3 credits** **3 periods**

History of Western Civilization to Middle Ages

Survey of the origin and development of Western civilization and its institutions from prehistory through the Ancient World and the Middle Ages. Prerequisites: None.

HIS101 **3 credits** **3 periods**

History of Western Civilization Middle Ages to 1789

Survey of the origin and development of Western civilization and its institutions from the Renaissance and Reformation through Age of Enlightenment. Prerequisites: None.

HIS102 **3 credits** **3 periods**

History of Western Civilization 1789 to Present

Survey of origin and development of Western civilization and its institutions from French Revolution through the present. Prerequisites: None.

HIS103 **3 credits** **3 periods**

United States History to 1870

The political, economic, and social development of United States from Colonial through Reconstruction period. Prerequisites: None.

HIS104 **3 credits** **3 periods**

United States History 1870 to Present

The political, economic, and social development of United States from Reconstruction period up to present time. Prerequisites: None.

HIS105 **3 credits** **3 periods**

Arizona History

The prehistoric and contemporary Native American experience, Spanish colonial times, the Mexican National period, the U.S. federal territorial years, and Arizona's political and economic development during the twentieth century. Prerequisites: None.

HIS106 **3 credits** **3 periods**

Southwest History

Survey of Hispanic, Anglo, African-American and Native cultures of the peoples who have settled the American Southwest. Emphasis on cattle, mining, fur trade and transportation industries and role development of the region. Prerequisites: None.

HIS107 **3 credits** **3 periods**

Selected Issues in United States History

Survey of selected major issues in history of United States from early times to present. Prerequisites: None.

HIS108 **3 credits** **3 periods**

United States History 1945 to the Present

Survey of American history from 1945 to the present. Focuses on the political, social, economic and cultural history of the United States from the end of World War II to the present time. Includes domestic developments and foreign policy. Prerequisites: None.

HIS

HIS110 **3 credits** **3 periods**

World History to 1500

Survey of the economic, social, cultural, and political elements of world history from the beginning of human civilization to 1500. Prerequisites: None.

HIS111 **3 credits** **3 periods**

World History 1500 to the Present

Survey of the economic, social, cultural, and political elements of world history from 1500 to the present. Prerequisites: None.

HIS140 **3 credits** **3 periods**

American Indian History (AIS140)

Survey of American Indian history with emphasis on the last 200 years including developments in the 20th century. Focuses on selected groups such as the Cherokee, Iroquois Confederation, Navajo, Sioux and Indians of the Southwest in relation to cultural, economic, political and social continuity and changes. Topics include development and influence of federal policies, past and present issues confronting Native Americans and how Native American individuals and communities maintain their identities as they confront social changes. Prerequisites: None.

HIS173 **3 credits** **3 periods**

United States Military History

Focuses on the impact of the United States military in both peace and war on American society, politics and foreign relations from the colonial period to the present. Prerequisites: None.

HIS201 **3 credits** **3 periods**

History of Women in America

Introduction to women's history from the colonial period to the present. Deals chronologically with changes and developments which have influenced the lives of women. Prerequisites: None. *(HIS201 not offered every semester.)*

HIS203 **3 credits** **3 periods**

African-American History I

History and cultural heritage of African-Americans from their beginnings in Ancient Africa through the experience of chattel slavery in the Americas to their eventual emancipation and participation in the American Civil War. Prerequisites: None. *(HIS203 not offered every semester.)*

HIS204 **3 credits** **3 periods**

African-American History II

Multifaceted experiences of African-American people from the post-Civil War period (1865) to the present, including the collective struggle for freedom, equality, and self-determination in the United States. Prerequisites: HIS203. *(HIS204 not offered every semester.)*

HIS251 **3 credits** **3 periods**

History of England to 1700

History of England to 1660. Analysis of the major political, cultural, social, and intellectual, and social factors in English historical development from its earliest times till 1660. Prerequisites: None. Survey of the United States experience in Vietnam, 1945-1975, in view of political, economic and social forces of the Cold War. Prerequisites: None.

Course Descriptions

HIS252 3 credits 3 periods
History of England 1700 to Present
 Analysis of the major political, cultural, social, and intellectual factors in English historical development from 1650 to present. Prerequisites: None.

HIS254 3 credits 3 periods
History of Ireland 1603 to the Present
 Survey of the history of Ireland, including the contemporary Republic of Ireland and Northern Ireland, from 1603 to the present. Prerequisites: None.

HIS273 3 credits 3 periods
United States Experience in Vietnam 1945-1975
 Survey of the United States experience in Vietnam, 1945-1975, in view of political, economic and social forces of the Cold War. Prerequisites: None.

HIS275 3 credits 3 periods
Soviet Union and Slavic World
 Survey of the principal political, military, economic, social, and cultural developments in the Soviet Union from the Communist seizure of power in 1917 to the present. Includes a brief review of the geography, politics, and culture of pre-1917 Russia as a background. Prerequisites: None. (*HIS275 not offered every semester.*)

HIS277 3 credits 3 periods
The Modern Middle East
 Survey of the political and economic development of the Middle East since 1500. Emphasis on the decline of the Moslem empire, the resurgence of contemporary Pan-Arabian, the Palestinian-Israeli question and the impact of oil production on the region and the rest of the world. Prerequisites: None.

HOSPITALITY & TOURISM MANAGEMENT HRM **Hotel, Golf and Restaurant Management**

Hospitality, Tourism and Culinary Arts
 Division Office AP 237A (480) 423-6578

ALSO SEE: Culinary Arts (CUL), page 145
 Recreation (REC), page 199

HRM110 3 credits 3 periods
Introduction to Hospitality and Tourism Management
 A fundamental overview of the hotel, restaurant, and tourism segments of the hospitality and tourism industry. Provides an overview of the operational sectors of the industry and reviews management components and skills. Contains components to develop communication skills and a professional career plan. Prerequisites: None.

HRM120 3 credits 3 periods
Hotel Facility Management
 Fundamental duties and responsibilities of hotel facility management. Emphasis on detail tasks, including personnel, cleaning, purchasing, equipment, textiles, maintenance, and safety. Examines basic systems for hotel facility management record keeping. Prerequisites: None.

HRM130 3 credits 3 periods
Guest Services Management
 Examines organization and management of the hotel front office and guest service operations. Explores key front office functions and related systems and skills necessary to ensure guest satisfaction and efficient operations. Prerequisites: None.

HRM140 3 credits 3 periods
Food Production Concepts
 Concepts related to preparation of hot foods, pantry, and bakery items for commercial kitchens. Emphasis on essential components and techniques of food production, food cost control, setting standards, ordering, and inventory. Prerequisites: None.

HRM145 3 credits 3 periods
Events Management
 Introduction to organizing special events from concept through completion, including planning, coordination, marketing, financing and risk management. Overview of the critical stages and functions involved in staging and managing special events including meetings, conferences, entertainment, expositions, conventions and sporting events. Prerequisites: HRM110.

HRM150 3 credits 3 periods
Hospitality and Tourism Information Systems I
 Overview of current computer technology, concepts and terminology as it applies to the hospitality and tourism industry. Use of software applications including word processing, spreadsheet, database and presentation graphics. Discussion of social and ethical issues related to computers. Exploration of relevant and emerging technologies in the industry. Prerequisites: HRM110.

HRM220 3 credits 3 periods
Hospitality Managerial Accounting
 Study of financial statement analysis, asset management, ratio analysis, analytical techniques, and investment decision making. Emphasis on planning, budgeting, and management decisions. Prerequisites: ACC211.

HRM230 3 credits 3 periods
Beverage Management
 Identification, production, purchasing, and service of spirits, wine and beer products. Marketing, menu development, and cost controls of a beverage operation. Special emphasis on staffing, training and legal regulations for beverage sales. Prerequisites: None.

HRM235 3 credits 3 periods
Club Management
 Examines organization and management of private clubs. Emphasis on member services and operations management. Explores key functions including food and beverage, golf operations, fitness and recreation programs. Prerequisites: HRM110.

HRM240 3 credits 3 periods
Commercial Food Production
 Application of food preparation principles, procedures and techniques to small and large quantity food production. Emphasis on techniques and procedures used in contemporary commercial kitchens. Prerequisites: HRM110 and HRM140.

Course Descriptions

HRM250 3 credits 3 periods
Hospitality and Tourism Information Systems II

Use of computer systems to generate information needed for management of lodging, tourism and food service businesses. Emphasis on computer-based hotel property and restaurant management systems. Includes basic ledger principles. Prerequisites: (HRM110 and HRM150) or permission of instructor.

HRM260 3 credits 3 periods
Hospitality Human Resource Management

Examines concepts and applications of human resource management in the hospitality industry. Topics include recruitment, selection, training and evaluation. Emphasis on current management methods and productivity in the service environment. Prerequisites: HRM110 or approval of instructor.

HRM270 3 credits 3 periods
Hospitality Marketing

Essential skills of defining a service market, developing a market plan and directing personnel to follow marketing plan. Emphasis on marketing in the hospitality industry and understanding segmentation, positioning and promotion in that market. Prerequisites: None.

HRM275 3 credits 3 periods
Restaurant Management

Overview of restaurant industry with focus on the major segments. Emphasis on developing plans for marketing, accounting system, staffing, training, menu development and cost controls for restaurant operation. Special emphasis on safety and sanitation, and legal regulations in the restaurant industry. Prerequisites: None.

HRM280 3 credits 3 periods
Hospitality and Tourism Law

Examines legal aspects of hotel, restaurant and tourism management. Uses case study approach to develop understanding of the laws and regulations governing guest relationships, contracts, employee relations, civil rights, alcoholic beverages, safety and product liability. Prerequisites: HRM110.

HRM285 3 credits 3 periods
Gaming Management

History, development, and management of casinos and gaming. Emphasis on environment, operations, regulation, accounting, auditing, and taxation of casinos and gaming operations. Prerequisites: None.

HRM290 3 credits 3 periods
Ecotourism

Overview of ecotourism planning and development with emphasis on contemporary issues associated with environmentally sound, culturally sensitive and economically viable tourism development. Examines the history and emergence of ecotourism and the establishment of policies and management practices associated with sustainable development that conserves natural resources while providing economic benefits. Prerequisites: HRM110.

HRM291 3 credits 15 periods
Directed Field Study – International

Directed international field study in hospitality or tourism at an approved site working with industry, government or the nonprofit sector. A supervised, independent field study project may be substituted with approval of the instructor. Designed to provide students the opportunity to integrate theories, principles, and practices from their program of study through practical application in an international setting. Includes a minimum of 240 documented hours of contact with the employer/subject of study at minimum. Prerequisites: Completion of 15 credits in the Hospitality and Tourism Program, a 3.0 or higher grade point average, and permission of the program director. *Course Note: May be repeated for a total of six (6) credits with program permission.*

HUMANITIES

HUM

Communication Arts Office LC 305 (480) 423-6076
Fine Arts Division Office MB 139 (480) 423-6328

HUM105AB 1 credit 1 period
Cultural Perspectives: Native American Ideas and Values

An interdisciplinary examination of the history, arts, ideas and values of Native Americans and their contribution to life in the United States. Prerequisites: None. *(HUM105AB not offered every semester.)*

HUM190AA-AI 1 credit 1 period
Honors Forum

Interdisciplinary studies of selected issues confronting the individual and society. Formal lectures followed by informal discussions with outstanding scholars and social leaders. Supplemented by readings and pre- and post-forum discussion and critique. Varied content from module to module due to changing forum themes and issues. Prerequisites: Admission to the College Honors Program or permission of instructor.

HUM205 3 credits 3 periods
Introduction to Cinema (THE205)

Survey of the history and development of the art of motion pictures, including criticism of aesthetic and technical elements. Prerequisites: None.

HUM209 3 credits 3 periods
Women and Films (WST209)

Analysis of images of women in films from both historical and contemporary perspectives. Prerequisites: None.

HUM210 3 credits 3 periods
Contemporary Cinema (THE210)

A study of contemporary films, directors and critics with emphasis on evaluating film as an art form. Prerequisites: None.

Course Descriptions

HUM211AA 3 credits 3 periods

Foreign Films: Classics

Analysis of contributions of foreign directors to the art and history of motion pictures through a study of selected films. Prerequisites: None.

HUM250 3 credits 3 periods

Ideas and Values in the Humanities

An historical analysis of the interrelationships of art, architecture, literature, music, and philosophy from the early civilizations to the Renaissance, including western and non-western cultures. Prerequisites: ENG101. (*HUM250 offered Fall semester only.*)

HUM251 3 credits 3 periods

Ideas and Values in the Humanities

An historical analysis of the interrelationships of art, architecture, literature, music, and philosophy from the Renaissance to modern period, including western and non-western cultures. Prerequisites: ENG101. (*HUM250 offered Spring semester only.*)

HUM260 3 credits 3 periods

Intercultural Perspectives

Cultural, literary, and artistic expressions of Native, Hispanic and African Americans. Includes traditional and modern work and contribution to American civilization. Prerequisites: None. (*HUM260 not offered every semester.*)

INFANT/TODDLER DEVELOPMENT

ITD

Social/Behavioral Sciences Division SB 130 (480) 423-6206

ALSO SEE: Child/Family Studies (CFS), page 134,
Early Childhood Development (ECH), page 150
Early Education (EED), page 151
Family and Consumer Science (FCS), page 165

ITD183 1 credit 1 period

Infant/Toddler Learning Materials (ECH183)

Safety and design features of commercial, homemade, and household learning materials for children from birth through 30 months of age. Focus on matching items with children's developmental levels. Prerequisites: None.

ITD205 1 credit 1 period

Emerging Individuality

An overview of the range of differences among infants and toddlers as they develop in the first three years of life. Includes consideration of physical variation, temperaments and multiple intelligences. Prerequisites: None.

ITD260 1 credit 2 periods

Reflective Case Study

An extended relationship with an infant or toddler and their primary caregiver in the child's own home setting. Weekly visits with the child and family members, reflective journal keeping and regular class meetings with fellow students and instructor. May be repeated for up to four credits. Prerequisites: Current enrollment in Infant/Toddler Program; must have completed at least five program credit hours, and permission of instructor.

INFORMATION STUDIES

IFS

Library Division Office LB 162 (480) 423-6653

IFS101 3 credits 3 periods

Information Skills in the Digital Age

Development of skills and competency in accessing, evaluating and using information resources while examining the social and historical context as well as the technological implications of the use and organization of information. Prerequisites: ENG101, or ENG107, or equivalent.



INTERIOR DESIGN

INT

Applied Sciences Division Office AP 237B (480) 423-6599

INT105 3 credits 3 periods

Introduction to Interior Design

Introduction to the profession of interior design, including design process, elements and principles of design, and basic concepts of space planning and furniture layout. Development of design vocabulary relative to architectural details, furnishings, and finishes. Prerequisites: None.

INT115 3 credits 3 periods

Historical Architecture and Furniture

Historical survey of the development of furniture, interiors, and architecture from antiquity to the 19th Century. Prerequisites: None.

INT120 3 credits 3 periods

Modern Architecture and Furniture

Survey of the development of furniture, interiors, and architecture from the 19th Century to the present. Emphasis is on modern architects and designers. Prerequisites: None.

INT145 3 credits 6 periods

Drawing and Rendering

Development of basic freehand sketching and perspective drawing skills. Explores styles and techniques with emphasis on quick sketch and presentation type drawings as used by design professionals. Prerequisites: ARC121 or DFT121.

Course Descriptions

<p>INT150 Color and Design Introduction to the theory and application of color as related to the elements and principles of design. Light and its effect on color. Emphasis on the development of presentation skills for the field of interior design. Prerequisites: None.</p>	<p>3 credits 6 periods</p>
<p>INT160 Fabrics for Interiors Study of the properties, design, and performance characteristics of interior fabrics. Psychological and cultural impact of textiles on the built environment. Role of the interior designer in working with textiles. Introduction to regulations and codes within the textile industry. Prerequisites: None.</p>	<p>3 credits 3 periods</p>
<p>INT170 Interior Materials Properties, performance, maintenance, sustainability and general characteristic of interior finishes, furnishings, and equipment. Emphasis on building a resource file of interior finishes, furnishings, and equipment sources. Prerequisites: INT105. Prerequisite or Corequisite: INT160.</p>	<p>3 credits 6 periods</p>
<p>INT190 Space Planning Study of creative, critical, analytical and strategic thinking as it relates to human behavior and the built environment. Emphasis on the design process and tasks within each phase of the process. Stresses creative expression through the utilization of design elements and principles. Prerequisites: INT105 and (ARC121 or DFT121). INT140 or (ARC141 or DFT105) recommended but not required.</p>	<p>3 credits 6 periods</p>
<p>INT210 Interior Sales and Marketing Marketing procedures and sales techniques for interior designers. Prerequisites: INT190.</p>	<p>3 credits 3 periods</p>
<p>INT215 Professional Practices Marketing and business processes used in interior design studios. Ethical issues facing interiors industry. Development of business plan. Prerequisites: INT190. (<i>Note: Students must be enrolled in the SCC INT third-year Professional Level Certificate Program.</i>)</p>	<p>3 credits 3 periods</p>
<p>INT225 History of Decorative Arts Survey of historical art, furniture and interiors with an emphasis on decorative arts from various cultures. Prerequisites: INT115 and INT120.</p>	<p>3 credits 3 periods</p>
<p>INT230 Presentation Techniques Advanced freehand sketching and perspective drawing skills. Explores a variety of styles and techniques with emphasis on presentation type drawings and portfolio development techniques used by design professionals. Prerequisites: INT145.</p>	<p>3 credits 6 periods</p>

<p>INT240 Kitchen and Bath Design Exploration into the specific requirements associated with kitchen and bath design. Emphasis on the design process and computer-based tools for interior design. Prerequisites: INT190 and [(ARC141 or DFT105) or INT140].</p>	<p>3 credits 6 periods</p>
<p>INT260 Interior Codes and Regulations Study of interior building codes, regulations, and standards and their impact on the health, safety, and welfare of the public. Emphasis on occupancy classifications, means of egress, fire protection, finish/furniture standards and testing, and Americans with Disabilities Act Accessibility Guidelines (ADAAG). Prerequisites: AAS Degree in Interior Design or permission of department.</p>	<p>3 credits 3 periods</p>
<p>INT265 Building Systems Study of building systems and their impact on the health, safety and welfare of the public. Prerequisites: AAS Degree in Interior Design or permission of department.</p>	<p>3 credits 3 periods</p>
<p>INT268 Lighting Design Study of interior lighting design and its impact on the health, safety and welfare of the public. Prerequisites: AAS Degree in Interior Design or permission of department.</p>	<p>3 credits 6 periods</p>
<p>INT270 Commercial Design Creation of design solutions for commercial spaces. Focuses on issues affecting the health, safety and welfare of the public. Prerequisites: AAS Degree in Interior Design or permission of instructor.</p>	<p>3 credits 6 periods</p>
<p>INT271AA Interior Design Internship Interior design work experience in the interiors industry. Required to work 80 hours. Supervised and evaluated by a faculty coordinator. Prerequisites: Departmental approval. <i>Course Note: May be repeated for a total of four (4) credits with department permission.</i></p>	<p>1 credit 5 periods</p>
<p>INT271AB Interior Design Internship Interior design work experience in the interiors industry. Required to work 160 hours. Supervised and evaluated by a faculty coordinator. Prerequisites: Departmental approval. <i>Course Note: May be repeated for a total of four (4) credits with department permission.</i></p>	<p>2 credits 10 periods</p>
<p>INT271AC Interior Design Internship Interior design work experience in the interiors industry. Required to work 240 hours. Supervised and evaluated by a faculty coordinator. Prerequisites: Departmental approval.</p>	<p>3 credits 15 periods</p>
<p>INT274AA Interior Design Study Tour A tour of the interior design industry outside of the metropolitan Phoenix area. Includes a variety of experiences and activities to enhance knowledge about this multi-faceted career. Prerequisites: Departmental approval.</p>	<p>1 credit 5 periods</p>

Course Descriptions

INTERNATIONAL BUSINESS

IBS

Business Division Office AP 237A (480) 423-6253

IBS101 3 credits 3 periods

Introduction to International Business

A basic overview of international business to introduce students to international trade concepts. Focus of the course is on international business environment issues that influence global business practices, decisions and applications. Prerequisites: None.

IBS201 3 credits 3 periods

International Studies for Business (*Fastrack*)

Provides an overview of the major issues faced by managers in international business. Focuses on cultural sensitivity issues and applying concepts to real-world business situations through case studies and experiential exercises. Prerequisites: None. (*Offered in both on-campus and online formats.*)

ITALIAN LANGUAGE

ITA

Language/Communication Division LC 305 (480) 423-6459

ITA101 4 credits 4 periods

Elementary Italian I

Basic grammar, pronunciation and vocabulary of the Italian language. Includes the study of Italian culture. Practice of listening, speaking, reading and writing skills. Prerequisites: None.

ITA101AA 4 credits 5 periods

Elementary Italian I

Basic grammar, pronunciation and vocabulary of the Italian language. Includes the study of Italian culture. Practice of listening, speaking, reading and writing skills. Prerequisites: None.

ITA102 4 credits 4 periods

Elementary Italian II

Continued study of grammar and vocabulary along with the study of Italian culture. Emphasis on speaking, reading and writing skills. Prerequisites: ITA101 or equivalent.

ITA102AA 4 credits 5 periods

Elementary Italian II

Continued study of grammar and vocabulary along with the study of Italian culture. Emphasis on speaking, reading and writing skills. Prerequisites: ITA101 or equivalent.

ITA115 3 credits 3 periods

Beginning Italian Conversation I

Conversational Italian. Basic sentence structure, pronunciation and vocabulary necessary to develop speaking ability in Italian. Designed for students seeking speaking and listening abilities with little emphasis on grammar. Prerequisites: None.

ITA116 3 credits 3 periods

Beginning Italian Conversation II

Continued development of speaking and listening skills for effective communication in Italian. Prerequisites: ITA115 or equivalent or departmental approval.

ITA201 4 credits 4 periods

Intermediate Italian I

Review of essential grammar of the Italian language and study of the Italian culture. Continued practice and development of reading, writing, and speaking skills. Prerequisites: ITA102 or equivalent or departmental approval.

ITA202 4 credits 4 periods

Intermediate Italian II

Continued development of Italian language skills and continued study of the Italian culture. Prerequisites: ITA201, or equivalent, or departmental approval.

ITA225 3 credits 3 periods

Intermediate Italian Conversation I

Continued development of skills in conversational Italian for effective communication. A review of grammar and development of vocabulary. Intensified study of Italian life and culture. Prerequisites: ITA116, or ITA102, or departmental approval.

ITA226 3 credits 3 periods

Intermediate Italian Conversation II

Continued development of skills in conversational Italian for effective communication. A review of grammar including the extensive use of grammatical concepts. Continued development of vocabulary. Intensified study of Italian life and culture. Prerequisites: ITA225, or ITA201, or departmental approval.



Course Descriptions

JAPANESE LANGUAGE

Language/Communication Division LC 305 (480) 423-6459

JPN101 **5 credits** **6 periods**

Elementary Japanese I

Basic grammar, pronunciation, and vocabulary of Japanese. Study of Japanese culture. Development of speaking, listening, reading and writing skills. Prerequisites: None.

JPN102 **5 credits** **6 periods**

Elementary Japanese II

Continued study of basic grammar, pronunciation and vocabulary of Japanese. Study of the Japanese culture. Intensive practice in oral communication and development of reading and writing skills. Prerequisites: JPN101 or departmental approval.

JPN115 **3 credits** **3 periods**

Beginning Japanese Conversation I

Conversational Japanese. Basic sentence structure, pronunciation, and vocabulary necessary to develop speaking ability in Japanese. Designed for students seeking speaking and listening abilities with little emphasis on grammar, reading, or writing. Prerequisites: None.

JPN116 **3 credits** **3 periods**

Beginning Japanese Conversation II

Continuation of conversational Japanese for survival in everyday business and social situations. Expansion of vocabulary and sentence structure through aural/oral practice. Practice in reading and writing Kana. Prerequisites: JPN115.

JPN201 **5 credits** **6 periods**

Intermediate Japanese I

Expansion of sentence structure through oral/aural practice. Increased emphasis on reading and writing in Japanese and study of Japanese culture. Prerequisites: JPN102 or equivalent.

JPN202 **5 credits** **6 periods**

Intermediate Japanese II

Extensive review of Japanese grammar; development of vocabulary and idiomatic expressions through reading and writing. Continued practice of oral communication skills and study of Japanese culture. Prerequisites: JPN201 or equivalent.

JOURNALISM

Language/Communication Division LC 305 (480) 423-6459

JRN201 **3 credits** **5 periods**

News Writing

Writing news for the print media. Composing at the computer keyboard. Associated Press editing style, writing skills and organizational structure for news. Prerequisites: ENG101 or ENG107 or equivalent.

JRN212 **3 credits** **5 periods**

Broadcast Writing

Writing techniques for basic broadcast scripts: promotions, commercials, public service announcements, news leads, news stories, audio and video, sports, weather, traffic checks, five-minute newscasts, reports, using broadcast style rules. Prerequisites: ENG101.

JPN

JRN215 **3 credits** **5 periods**

News Production

Writing, editing and publishing the student newspaper. Emphasis on news judgment, page design, computer pagination, photo usage, headline writing, editorial writing, newsroom management, and legal and ethical considerations. Emphasis may vary according to student goals. Prerequisites: None.

JRN234 **3 credits** **3 periods**

Feature Writing

Emphasis on crafting stylized stories for publications. Includes research, interviewing, writing techniques, editing and professional concerns. Prerequisites: ENG101 or ENG107 or equivalent.

LEADERSHIP

LDR

Communication Arts Dept. Office LC 305 (480) 423-6076
Fine Arts Division Office MB 139 (480) 423-6328

LDR101 **2 credits** **2 periods**

Emerging Leaders I

Concepts and application of leadership skills and service learning to promote social change and value clarification. Development of organizational leadership skills through experiential learning. Prerequisites: None.

MANAGEMENT

MGT

Business Division Office AP 237A (480) 423-6253

See requirements listed for certificate programs and associate degrees under Business, Business (Fastrack), Hospitality and Tourism/Golf Management, Hospitality and Tourism/Hotel Management, Hospitality and Tourism/Restaurant, and Office Automation Systems.

MGT101 **3 credits** **3 periods**

Techniques of Supervision

Overview of the foundations of supervision and how to get things done within an organization through other people. The functions of planning, organizing, staffing, motivating and controlling presented. Prerequisites: None.

MGT109 **3 credits** **3 periods**

Development of Professional Skills and Standards (Fastrack)

Explores the skills and qualities necessary to develop and maintain a successful professional life. Topics include management/leadership skill development, effective job search, image development, career advancement, gender issues, professional conduct, time/financial management, and human relations. Prerequisites: None. (*Offered in both on-campus and online formats.*)

MGT113 **3 credits** **3 periods**

Proposal Writing (AIS113)

Provides an overview of funding sources for grants. Reviews techniques and skills necessary to develop successful proposals. Focuses on the design and writing of a complete grant proposal related to a selected problem or issue. Prerequisites: None.

Course Descriptions

MGT126 3 credits 3 periods
Customer Service Skills and Strategies (Fastrack)
 Explores strategies to help improve job performance and develop a service-oriented philosophy. Uses practical training concepts and techniques to demonstrate how superior customer service can lead to competitive advantage and profitability in business. Focuses on both internal and external customers, interactions among people, processes, and systems within the organization and how to integrate these areas into a total quality delivery program. (*Offered in both on-campus and online formats.*)

MGT127 3 credits 3 periods
Managing and Leading for Competitive Advantage (Fastrack)
 Practical training in the development of skills and expertise necessary to achieve organizational goals, with and through people. Examines functions and work activities that result in a more productive and harmonious workforce. Prerequisites: None. (*Offered in both on-campus and online formats.*)

MGT172 1 credit 1 period
Organizations, Paradigms and Change
 Examines the nature of organizations, paradigms, and change as organizations manage for excellence. Focuses on current practices and future trends in total quality management. Includes ethics and the future of organizations in a global economy. Prerequisites: None.

MGT175 3 credits 3 periods
Business Organization and Management
 Covers basic principles of managing quality and performance in organizations. Covers management functions: planning, organizing, leading, and controlling. Emphasizes continual improvement, ethics and social responsibility. Prerequisites: None.

MGT179 3 credits 3 periods
Utilizing the Human Resources Department (Fastrack)
 Provides the opportunity to learn how to appropriately utilize the human resources department within an organization in order to improve job performance. Topics include staffing, training and development, manpower planning, compensation and benefits, federal labor laws and why people seek outside representation. Prerequisites: None. (*Offered in both on-campus and online formats.*)

MGT201 1 credit 1 period
Tribal Management Seminar I (AIS201)
 Discussion of the relationship between general management issues and their specific application to tribal government situations. Special consideration given to application of management theory and to the unique status and situation of tribal governments. Prerequisites: None.

MGT202 1 credit 1 period
Tribal Management Seminar II (AIS202)
 Discussion of the relationship between general management issues and their specific application to tribal government situations. Special consideration given to application of management theory and to the unique status and situation of tribal governments. Prerequisites: MGT201 or permission of instructor.

MGT203 3 credits 3 periods
Fundamentals of Economic Development for Indigenous Nations (AIS203)
 Provides a practical understanding of the economic development process. Examines ways in which development can be initiated and financed. Focuses on how budget systems can be used as management tools. Reviews fundamentals of proposal writing and budget management for grants. Prerequisites: ACC230 or permission of instructor.

MGT206 3 credits 3 periods
Business Research Project (Fastrack)
 Reviews basic principles and techniques for conducting research. Includes criteria for evaluation of research. Involves an in-depth analysis of a selected topic related to contemporary business. Focuses on selection of topic, research design, collection and analysis of data, and preparation and presentation of a research report. Prerequisites: Completion of a minimum of 15 credits in the Business Fastrack Program with a grade of C or better.

MGT251 3 credits 3 periods
Human Relations in Business
 Analysis of motivation, leadership, communications, and other human factors. Cultural differences that may create conflict and affect morale individually and within organizations. Prerequisites: None. MGT101, or MGT175, or MGT229 suggested but not required.

MGT253 3 credits 3 periods
Owning and Operating a Small Business
 Starting, organizing, and operating a small business, including location, finance management processes, advertisement and promotion, credit, inventory control and ethics. Prerequisites: None. (*Offered in both on-campus and online formats.*)

MGT276 3 credits 3 periods
Personnel/Human Resource Management
 Human resource planning, staffing, training, compensating, and appraising employees in labor-management relationships. Prerequisites: None. MGT101, or MGT175, or MGT229 suggested but not required.

MARKETING **MKT**
 Business Division Office AP 237A (480) 423-6253
See requirements listed for certificate programs and associate degrees under Business.

MKT101 3 credits 3 periods
Introduction to Public Relations
 Emphasizes public relations techniques used both within and outside the business organization, including operation of a PR counseling firm. Prerequisites: None.

MKT109 3 credits 3 periods
Introduction to Fashion Merchandising (TEC109)
 Explores the various levels and specialized segment of the fashion industry, the principles of fashion, the fundamentals of merchandising apparel, consumers influence on demand and marketing activities. Prerequisites: None.

Course Descriptions

MKT151 3 credits 4 periods
Display and Visual Merchandising (TEC151)

An examination of the principles of design including line, color, balance, and texture as they relate to the display of merchandise. Participation in displays, field trips, and individual projects. Prerequisites: None.

MKT200 3 credits 3 periods
Retail Buying (TEC200)

Examines management/buyer role in investment, pricing, planning, controlling sales and inventories. Prerequisites: None. Any BPC/CIS spreadsheet course recommended.

MKT210 3 credits 3 periods
Applied Marketing Strategies (Fastrack)

Examines the principles and terminology utilized in the marketing function and their value and application in the day-to-day operation of a business. Focuses on marketing planning, market segmentation, positioning, targeting and aspects of international marketing. Reviews product development, pricing, promotion and distribution and explores careers in marketing. Prerequisites: None. (*Offered in both on-campus and online formats.*)

MKT263 3 credits 3 periods
Advertising Principles

Introduces the advertising function within business, including media study, creative strategies, and advertising campaigns. Prerequisites: None. MKT271 suggested, but not required.

MKT267 3 credits 3 periods
Principles of Salesmanship

Analyzes and applies the steps and techniques used in personal selling. Highlights the role of the professional sales representative and his/her functions as they relate to the company's mission and customer expectations. Prerequisites: None.

MKT268 3 credits 3 periods
Merchandising

Surveys structure and operation of retail organizations. Emphasizes merchandising to include price, location, time promotion and quantity. Prerequisites: None. MKT271 suggested but not required. (*Offered in both on-campus and online formats.*)

MKT271 3 credits 3 periods
Principles of Marketing

An analysis of the marketing process and environment with regard to the product, pricing, distribution and communication in order to satisfy buyer needs. Prerequisites: None.

MASS COMMUNICATION

Language/Communication Division LC 305 (480) 423-6459

MCO

MCO120 3 credits 3 periods
Media and Society

Study of historical and contemporary roles of media and its pervasiveness in society as it relates to politics, education and culture. Prerequisites: ENG101 or ENG107 or equivalent.

MATHEMATICS

MAT

Mathematics/Sciences Division PS 153 (480) 423-6111

Mathematics Value Statement

Rapid change and growing complexity characterize our world. In this context, the ability to think critically is an increasingly important skill.

As a discipline that encompasses many forms of reasoning, mathematics is in a position to foster critical thinking and other higher-order thinking skills.

Students become critical thinkers in mathematics not only through the acquisition of course-specific knowledge and skills, but also through the development of skills in problem solving, decision making, and communication. Accordingly, all mathematics courses in the Maricopa Community College District are designed to help develop the following:

To foster critical thinking, students interpret evidence, identify arguments pro and con, analyze and evaluate alternative points of view, reach conclusions, justify results and procedures, and explain assumptions and reasons.

When solving problems, students identify the problem to be solved, determine the strategy(ies) to solve the problem, apply the selected strategy(ies), judge the correctness and appropriateness of the solution, and interpret and communicate the solution.

When making decisions, students identify the various options that could be used, select an appropriate or reasonable option(s), justify the option(s) selected, and verify the reasonableness or validity of their conclusions. To develop effective communication skills, students use mathematical language and vocabulary; explain a problem-solving or decision-making process in an understandable and logical sequence; use a variety of resources, materials, or methods; and interpret and respond to mathematical communication received from others.

MAT081 4 credits 4 periods
Basic Arithmetic

Primary emphasis placed on fundamental operations with whole numbers, fractions, decimals, integers, and rational numbers; proportions; and percentages. Other topics include representations of data, geometric figures, and measurement. Prerequisites: None.

MAT082 3 credits 3 periods
Basic Arithmetic

Primary emphasis placed on fundamental operations with whole numbers, fractions, decimals, integers, and rational numbers; proportions; and percentages. Other topics include representations of data, geometric figures, and measurement. Prerequisites: None.

MAT090 5 credits 5 periods
Developmental Algebra

Linear behavior; linear equations and inequalities in one and two variables; graphs; systems of equations in two variables; function notation, graphs, and data tables; operations on polynomials; properties of exponents; applications. May receive credit for only one of the following: MAT090, MAT091, MAT092, or MAT093. Prerequisites: Grade of C or better in MAT082, or MAT102, or equivalent, or satisfactory score on District Placement exam.

Course Descriptions

MAT091 **4 credits** **4 periods**
Introductory Algebra
Linear behavior; linear equations and inequalities in one and two variables; graphs; systems of equations in two variables; function notation, graphs, and data tables; operations on polynomials; properties of exponents; applications. May receive credit for only one of the following: MAT090, MAT091, MAT092, or MAT093. Prerequisites: Grade of C or better in MAT082, or MAT102, or equivalent, or satisfactory score on District placement exam.

MAT092 **3 credits** **3 periods**
Introductory Algebra
Linear behavior; linear equations and inequalities in one and two variables; graphs; systems of equations in two variables; function notation, graphs, and data tables; operations on polynomials; properties of exponents; applications. May receive credit for only one of the following: MAT090, MAT091, MAT092, or MAT093. Prerequisites: Grade of C or better in MAT082, or MAT102, or equivalent, or satisfactory score on District placement exam.

MAT102 **3 credits** **3 periods**
Mathematical Concepts/Applications
A problem-solving approach to mathematics as it applies to life and the world of work. Development, demonstration, and communication of mathematical concepts and formulas that relate to measurement, percentage, statistics, and geometry. Prerequisites: Grade of C or better in MAT082, or equivalent, or satisfactory score on District placement exam.

MAT120 **5 credits** **5 periods**
Intermediate Algebra
Quadratic, rational, radical, exponential, and logarithmic functions and equations; graphs of quadratic, exponential, and logarithmic functions; equations quadratic in form; operations on rational expressions, radical expressions, and complex numbers; rational exponents; applications. May receive credit for only one of the following: MAT120, MAT121, or MAT122. Prerequisites: Grade of C or better in MAT090, MAT091, MAT092, or MAT093, or equivalent, or a satisfactory score on the District placement exam.

MAT121 **4 credits** **4 periods**
Intermediate Algebra
Quadratic, rational, radical, exponential, and logarithmic functions and equations; graphs of quadratic, exponential, and logarithmic functions; equations quadratic in form; operations on rational expressions, radical expressions, and complex numbers; rational exponents; applications. May receive credit for only one of the following: MAT120, MAT121, or MAT122. Prerequisites: Grade of C or better in MAT090, MAT091, MAT092, or MAT093, or equivalent, or a satisfactory score on the District placement exam.

MAT122 **3 credits** **3 periods**
Intermediate Algebra
Quadratic, rational, radical, exponential, and logarithmic functions and equations; graphs of quadratic, exponential, and logarithmic functions; equations quadratic in form; operations on rational expressions, radical expressions, and complex numbers; rational exponents; applications. May receive credit for only one of the following: MAT120, MAT121, or MAT122. Prerequisites: Grade of C or better in MAT090, MAT091, MAT092, or MAT093, or equivalent, or a satisfactory score on the District placement exam.

MAT140 **5 credits** **5 periods**
College Mathematics
Working knowledge of college-level mathematics and its applications to real-life problems. Emphasis on understanding mathematical concepts and their applications. Topics include set theory, probability, statistics, finance, and geometry. Prerequisites: Grade of C or better in MAT120, or MAT121, or MAT122 or equivalent, or satisfactory score on District placement exam. *Course Note: appropriate for the student whose major does not require college algebra or precalculus.*

MAT141 **4 credits** **4 periods**
College Mathematics
Working knowledge of college-level mathematics and its applications to real-life problems. Emphasis on understanding mathematical concepts and their applications. Topics include set theory, probability, statistics, finance, and geometry. Prerequisites: Grade of C or better in MAT120, or MAT121, or MAT122 or equivalent, or satisfactory score on District placement exam. *Course Note: appropriate for the student whose major does not require college algebra or precalculus.*

MAT142 **3 credits** **3 periods**
College Mathematics
Working knowledge of college-level mathematics and its applications to real-life problems. Emphasis on understanding mathematical concepts and their applications. Topics include set theory, probability, statistics, finance, and geometry. Prerequisites: Grade of C or better in MAT120, or MAT121, or MAT122 or equivalent, or satisfactory score on District placement exam. *Course Note: appropriate for the student whose major does not require college algebra or precalculus.*

MAT150 **5 credits** **5 periods**
College Algebra/Functions
Analysis and interpretation of the behavior and nature of functions including polynomial, rational, exponential, logarithmic, power, absolute value, and piecewise-defined functions; systems of equations, modeling and solving real world problems. Additional topics may include matrices, combinatorics, sequences and series, and conics. Prerequisites: Grade of C or better in MAT120 or MAT121 or MAT122 or equivalent, or satisfactory score on District placement exam. *Course Note: May receive credit for only one of the following: MAT150, MAT151, MAT152 or MAT187.*

MAT151 **4 credits** **4 periods**
College Algebra/Functions
Analysis and interpretation of the behavior and nature of functions including polynomial, rational, exponential, logarithmic, power, absolute value, and piecewise-defined functions; systems of equations, modeling and solving real world problems. Additional topics may include matrices, combinatorics, sequences and series, and conics. Prerequisites: Grade of C or better in MAT120 or MAT121 or MAT122 or equivalent, or satisfactory score on District placement exam. *Course Note: May receive credit for only one of the following: MAT150, MAT151, MAT152 or MAT187.*

MAT156 **3 credits** **3 periods**
Mathematics for Elementary Teachers I
Focuses on numbers and operations. Algebraic reasoning and problem solving integrated throughout the course. Prerequisites: Grade of C or better in MAT142 or MAT150 or MAT151 or MAT152 or equivalent, or satisfactory score on District placement exam.

Course Descriptions

MAT157 3 credits 3 periods
Mathematics for Elementary Teachers II
Focuses on measurement, geometry, probability and data analysis. Appropriate technologies, problem solving, reasoning, and proof are integrated throughout the course. Prerequisites: MAT156 or equivalent.

MAT172 3 credits 3 periods
Finite Mathematics
An introduction to the mathematics required for the study of social and behavioral sciences. Includes combinatorics, probability, descriptive statistics, matrix algebra, linear programming and the mathematics of finance. Includes applications of technology in problem-solving. Prerequisites: Grade of C or better in MAT150, or MAT151, or MAT152, MAT187 or equivalent, or satisfactory score on District placement exam.

MAT182 3 credits 3 periods
Plane Trigonometry
A study of measures of angles, properties of graphs of trigonometric functions, fundamental identities, addition and half-angle formulas, inverse trigonometric functions, solutions of trigonometric equations, complex numbers and properties of triangle solution. May receive credit for only one of the following: MAT182 or MAT187. Prerequisites: Grade of C or better in MAT150, or MAT151, or MAT152, or equivalent, or concurrent registration in MAT150, or MAT151, or MAT152, or satisfactory score on District placement exam.

MAT187 5 credits 5 periods
Precalculus
A precalculus course combining topics from college algebra and trigonometry. Preparation for analytic geometry and calculus. May receive credit for only one of the following: MAT150, MAT151, MAT152, or MAT187. Prerequisites: Grade of B or better in MAT120, MAT121, or MAT122, or equivalent, or satisfactory score on a placement test. Strongly recommended that students have some knowledge of trigonometry.

MAT212 3 credits 3 periods
Brief Calculus
Introduction to the theory, techniques and applications of the differential and integral calculus of functions with problems related to business, life, and the social sciences. Prerequisites: Grade of C or better in MAT150, or MAT151, or MAT152, or MAT187 or equivalent, or satisfactory score on District placement exam.

MAT213 4 credits 4 periods
Brief Calculus
Introduction to the theory, techniques and applications of the differential and integral calculus of functions with problems related to business, life, and the social sciences. Prerequisites: Grade of C or better in MAT150, or MAT151, or MAT152, or MAT187 or equivalent, or satisfactory score on District placement exam.

MAT220 5 credits 5 periods
Analytic Geometry and Calculus I
Topics from analytic geometry with specific emphasis on inequalities and absolute value expressions, limits, continuity, the fundamental principles and formulae for differential and integral calculus along with their applications to geometry and mechanics, the mean value theorems and the fundamental theorem of calculus. May receive credit for only one of the following: MAT220 or MAT221. Prerequisites: Grade of C or better in (MAT150 or MAT151 or MAT152 and MAT182) or MAT187 or equivalent, or satisfactory score on district placement exam.

MAT225 3 credits 3 periods
Elementary Linear Algebra
Introduction to matrices, systems of linear equations, determinants, vector spaces, linear transformations and eigenvalues. Emphasizes the development of computational skills. Prerequisites: Grade of C or better in MAT212, or MAT220, or MAT221, or equivalent.

MAT227 3 credits 3 periods
Discrete Mathematical Structures
Introduction to lattices, graphs, Boolean algebras, and groups. Emphasis on topics relevant to computer science. Prerequisites: Grade of C or better in CSC100 and (MAT220, or MAT221, or equivalent) or permission of instructor.

MAT230 5 credits 5 periods
Analytic Geometry and Calculus II
Includes working on the elementary transcendental functions, techniques of integration, vector functions, and infinite series. May receive credit for only one of the following: MAT230 or MAT231. Prerequisites: Grade of C or better in MAT220 or MAT221 or equivalent.

MAT240 5 credits 5 periods
Calculus with Analytic Geometry III
Vector-valued functions of several variables, multiple integration, introduction to vector analysis. Prerequisites: Grade of C or better in MAT230 or MAT231.

MAT241 4 credits 4 periods
Calculus with Analytic Geometry III
Vector-valued functions of several variables, multiple integration, introduction to vector analysis. Prerequisites: Grade of C or better in MAT230 or MAT231.

MAT261 4 credits 4 periods
Differential Equations
Ordinary differential equations with applications including Laplace transforms with numerical methods. Prerequisites: Grade of C or better in MAT230, or MAT231, or equivalent.

MAT262 3 credits 3 periods
Differential Equations
Ordinary differential equations with applications including Laplace transforms with numerical methods. Prerequisites: Grade of C or better in MAT230 or MAT231 or equivalent.

MAT295 1 credit 1 period
Special Topics in Mathematics
Conceptual and computational aspects of a special topic in modern mathematics. Prerequisites: Permission of instructor.

Course Descriptions

MICROSOFT TECHNOLOGY

MST

CIS Department Office CM 404 (480) 423-6588

ALSO SEE: Business-Personal Computers (BPC), page 132
Cisco Network Technology (CNT), page 136
Computer Information Systems (CIS), page 137
Office Automation Systems (OAS), page 194

MST140 3 credits 4 periods

Microsoft Networking Essentials

Emphasis on local area network with overview of wide area networks. Includes terminology, hardware and software components, connectivity, network architecture, packet structure, topologies, communication standards and protocols, and security issues. Preparation for Microsoft certification examination. Prerequisites: None. Recommend BPC110 or CIS105 and BPC121AB.

MST146 2 credits 3 periods

Data Modeling and Relational Database Design

Top-down, systematic approach to developing a relational database and defining requirements as entities, attributes, and relationships. Developing an entity-relationship (ER) diagram that accurately reflects the business. Mapping the ER diagram to an initial database design. Prerequisites: CIS105, or MST140, or permission of instructor.

MST150 3 credits 4 periods

Microsoft Windows Professional

Knowledge and skills necessary to perform day-to-day administrative tasks in a Microsoft Windows-based network. Preparation for Microsoft certification examination. Prerequisites or Corequisites: CIS190, or MST140, or permission of instructor.

MST152 4 credits 5 periods

Microsoft Windows Server

Knowledge and skills necessary to install, configure, customize, optimize, network, integrate, and troubleshoot Windows server. Preparation for Microsoft certification examination. Prerequisites or Corequisites: Any MST150 course or permission of instructor.

MST155 3 credits 4 periods

Implementing Windows Network Infrastructure

Knowledge and skills to install, configure, maintain, and support a Microsoft Windows network infrastructure. Preparation for Microsoft certification examination. Prerequisites or Corequisites: Any MST152 course or permission of instructor.

MST157 3 credits 4 periods

Implementing Windows Directory Services

Knowledge and skills to install, configure, and administer Microsoft Windows Active Directory directory services. Preparation for Microsoft certification examination. Prerequisites: Any MST152 course or permission of instructor.

MST170 4 credits 5 periods

Visual Basic Desktop Application Development

Use of Visual Basic programming language to create database applications using Visual Data Access tools, ActiveX Controls, Component Objects, and Structured Query Language (SQL) Server database. Prerequisites: CIS159 or permission of instructor.

MST171 3 credits 4 periods

Microsoft FrontPage

Knowledge and skills to analyze, design, build, and implement enterprise Web sites using Microsoft FrontPage. Includes use of ActiveX components, databases, and FrontPage server extensions. Prerequisites: (CIS233BA or CIS233DA) and MST170, or permission of instructor.

MST172 4 credits 5 periods

Visual Basic .NET Web Application Development

Knowledge and skills to develop and implement Web-based applications using ASP.NET, Web forms, and the Microsoft.NET framework with Visual Basic. Preparation for Microsoft Certified Applications Developer (MCAD) certification examination. Prerequisites: (BPC/CIS133DA, or BPC/CIS133AA and BPC/CIS133BA and BPC/CIS133CA) and CIS259, or permission of instructor.

MST174 3 credits 4 periods

Microsoft Visual InterDev

Web site programming tasks to create enterprise-level Web sites that use Component Object Model (COM) components on both the client and the server. Preparation for Microsoft Certified Solutions Developer (MCSD) examination. Prerequisites: (CIS233BA or CIS233DA) and MST170, or permission of instructor.

MST232 3 credits 4 periods

Managing a Windows Network Environment

Knowledge and skills required to administer Windows network operating systems. Preparation for Microsoft certification examination. Prerequisites: MST140, MST150, and MST152, or permission of instructor.

MST242 4 credits 5 periods

Microsoft Exchange Server

Knowledge and skills required to plan, implement, and administer Microsoft Exchange Server. Preparation for Microsoft certification examination. Prerequisites: Any MST152 course or permission of instructor.

MST244 3 credits 4 periods

Microsoft SQL Server Administration

Knowledge and skills required to install, configure, and administer Microsoft SQL server. Preparation for Microsoft certification examination. Prerequisites: Any MST152 course, or MST170, or permission of instructor.

MST252 3 credits 4 periods

Microsoft Windows Network Upgrade

Evaluate differences between current version of Microsoft Windows network operating system and upgraded version. Intended for Microsoft network administrators seeking upgrade training. Prerequisites: MST152 or permission of instructor.

MST253 3 credits 4 periods

Designing a Microsoft Windows 2000 Directory Services Infrastructure

Provides students with the knowledge and skills necessary to plan and implement Microsoft Windows 2000 Directory Services in an enterprise environment. Prerequisites: Any MST152 course or permission of instructor.

Course Descriptions

MST254 **3 credits** **4 periods**
Microsoft SQL Server Design and Implementation
 Knowledge and skills required to design and implement databases using Microsoft SQL Server. Preparation for Microsoft certification examination. Prerequisites: CIS259, or any MST152 course, or permission of instructor.

MST255 **3 credits** **4 periods**
Designing Windows Network Infrastructure
 Knowledge and skills to create a networking services infrastructure design that supports network applications and the needs of an organization. Preparation for Microsoft certification examination. Prerequisites or Corequisites: MST155 or permission of instructor.

MST259 **3 credits** **4 periods**
Designing Windows Network Security
 Knowledge and skills to analyze business requirements and processes to design a security solution for a Microsoft Windows network. Preparation for Microsoft certification examination. Prerequisites or Corequisites: MST157 or permission of instructor.

MST270 **3 credits** **4 periods**
Microsoft Solution Architectures
 Knowledge and skills to analyze business requirements in a given scenario and define technical solution architectures to optimize business results using Microsoft development tools. Prerequisites: (ACC230 or GBS151) and MST170, or permission of instructor.

MILITARY SCIENCE

MIS

Applied Sciences Division Office AP 237B (480) 423-6599

MIS101 **3 credits** **5 periods**
Introduction to the Military I
 Overview of mission, organization and structure of the Army and its role in national defense; discussion of current military issues. Prerequisites: None.

MIS102 **3 credits** **5 periods**
Introduction to the Military II
 Introduces problem-solving methods, critical thinking, decision making, and group cohesion as applied in a military environment. Prerequisites: MIS101.

MIS201 **3 credits** **5 periods**
Introduction to Leadership Dynamics I
 Introduces interpersonal dynamics involved in military team operations; theory and application of military leadership principles. Prerequisites: None.

MIS202 **3 credits** **5 periods**
Introduction to Leadership Dynamics II
 Introduction to interpersonal dynamics involved in military team operations; theory and application of military leadership principles. Prerequisites: MIS201.

MOTION PICTURE/TELEVISION PRODUCTION TCM

MP/TV Department Office LC 305 (480) 423-6076
 Fine Arts Division Office MB 139 (480) 423-6328

The Motion Picture/Television Production Department offers courses for students who plan to enter the field of motion pictures and/or television production. Successful completion of the coursework will qualify students for the AAS degree in Motion Picture/Television Production. Students will receive hands-on practical training in a fine arts learning environment and may select one or more of several specialization tracks within the AAS degree. Certificates of Completion in Screenwriting, Broadcast Production, Film Production, Editing, and Film Analysis and Criticism are also available.

TCM100 **3 credits** **3 periods**
Digital Multimedia

Introduction to the major components of a multimedia project. Prerequisites: None.

TCM101 **3 credits** **3 periods**
Fundamentals of Radio and Television

History of American radio and television, government regulations, self-regulation of broadcasting, the relationship of networks and stations, the social and political aspects of radio and television programming, the role of mass communications in America, the socioeconomic pressures on the medium, and the responsibilities and purposes of mass communications. Prerequisites: None.

TCM111 **3 credits** **3 periods**
Screenwriting I

Provides an introduction to screenwriting for feature films. Prerequisites: None. *(Note: Completion of ENG101 and ENG102 prior to this course is strongly recommended.)*

TCM111AA **3 credits** **3 periods**
Screenwriting I: The Short Film

Provides an overview of screenwriting for short documentaries, training films, advertising commercials and infomercials. Prerequisites: TCM111.

TCM112 **3 credits** **3 periods**
Writing the Situation Comedy

Workshop for writing a script for the situation comedy. Prerequisites: TCM111. *(TCM112 not offered every semester.)*



Course Descriptions

TCM116 **3 credits** **3 periods**
Writing the Television Drama
 A workshop for writing a script for the television drama. Prerequisites: TCM111. *(TCM116 not offered every semester.)*

TCM120 **3 credits** **5 periods**
Introduction to Sound Design for Film and Video (MTC120)
 Basic principles of recording and mixing sound for film and video. Includes voice-over, automatic dialog replacement (ADR), foley, ambience, special effects and music. Emphasis on analog and digital recording techniques in the field as well as in a controlled environment. Prerequisites: (TCM100 and TCM136) or permission of instructor.

TCM131/131AA **4 credits** **6 periods**
Radio-Television Announcing
 Theory and practice in news reporting, commercial announcing, interviewing, studio anchoring, and of on-air technique in radio. Development of basic commercial announcing techniques including the study and practice of various dialects and characterization styles. Use of radio control room including radio equipment and specialized audio software programs for development of commercials. Prerequisites: None.

TCM134 **3 credits** **3 periods**
Pre-Production for Motion Picture and Television
 Introduction to elements of pre-production for motion picture and television. Focuses on aesthetics, scriptwriting, budgeting, and selecting cast and crew. Features pre-production meetings to establish style, location, art design, shot sheet/story board, sound design, shooting schedule and film stock/video tapes. Pre-production of one film project and one video project required. Prerequisites: TCM100 or permission of department.

TCM135 **3 credits** **3 periods**
Production for Motion Picture and Television
 Introduction to elements of production for motion picture and television. Focuses on directing, crew responsibilities, camera operation, lenses, lighting and sound recording. Production of one film shoot and one video shoot required. Prerequisites: TCM134 or permission of department.

TCM136 **3 credits** **3 periods**
Post-Production for Motion Picture and Television
 Introduction to elements of post-production for motion picture and television. Focuses on editing, titles, sound design and marketing strategies. Post-production and marketing of one film and one video required. Prerequisites: TCM135 or permission of department.

TCM140 **3 credits** **3 periods**
Modern Media Concepts
 Introduction to the mechanics of a variety of media including computation systems, still photography, film, sound recording systems, telegraph/telephone, radio, television/video, electricity, satellite and analogue/digital systems. Emphasis on the impact of these media on the individual, culture, and society. Prerequisites: None.

TCM151 **2 credits** **3 periods**
Broadcast Production
 Introduction to multi-camera television production in studio and on location. Emphasizes teamwork and group production through a variety of program types. Prerequisites: TCM136 or permission of instructor.

TCM180/180AA **4 credits** **6 periods**
Television Production Techniques
 Introduction to basic concepts of video production. Emphasis on operation of camcorders, microphones, lights, editing and post-production equipment. Prerequisites: TCM136 or permission of instructor.

TCM211 **3 credits** **3 periods**
Screenwriting II
 Workshop in screenwriting for feature films and television. Prerequisites: TCM111 or permission of instructor.

TCM213 **4 credits** **4 periods**
Motion Picture Workshop
 Practical work and classes in selected aspects of film production. May be repeated for a total of sixteen (16) credits. Prerequisites: TCM136 or permission of instructor. *(TCM213 not offered every semester.)*

TCM213AA **4 credits** **4 periods**
Motion Picture Workshop: On-Location Shooting
 Practical work and classes in film production. Features on-location shooting. Prerequisites: TCM136 or permission of instructor.

TCM214 **3 credits** **5 periods**
Television Workshop
 Practical work and classes in television production. Prerequisites: TCM136 or permission of instructor. *Course Note: May be repeated for a total of twelve (12) credits.*

TCM215 **3 credits** **3 periods**
Cinematography
 Intermediate workshop focusing on 16mm camera operation and lighting. Emphasis on the role of the cinematographer, camera operation and lens selection, interpreting the script, lighting, exposure meters, film stocks, and the aesthetics of editing. Shoot one short 16mm project and crew on two additional projects. Prerequisites: TCM136 or permission of instructor.

TCM216 **3 credits** **5 periods**
Screenwriting III
 Advanced workshop in narrative screenwriting for film and television. Prerequisites: TCM211.

TCM218 **3 credits** **5 periods**
Screenwriting IV
 Advanced workshop for writing a screen/teleplay. Prerequisites: TCM216.

TCM219 **3 credits** **3 periods**
Introduction to Television Technology
 Introduction to television technology and setup. Includes theoretical concepts, standards for television and video signals, practice in calibration and adjustment of signals, setup and control of field and studio cameras, setup of professional decks, character generation, video digitizing and compression, keying of titles and multi-layered video, and audio setup and troubleshooting. Prerequisites: TCM136 or permission of instructor.

TCM220 **3 credits** **5 periods**
Advanced Sound Design for Film and Video (MTC220)
 Explores techniques and advanced applications used in designing sound using original student footage on a non-linear editing system. Prerequisites: MTC/TCM120 or permission of instructor. *(TCM220 not offered every semester.)*

Course Descriptions

TCM225 **3 credits** **3 periods**
Film Noir

History, development and analysis of the noir film through a study of selected films, directors, studios, and the era that gave rise to this American film genre. Prerequisites: None. *(TCM225 not offered every semester.)*

TCM230 **4 credits** **4 periods**
Motion Picture Directing

Theory and practice in directing the motion picture. Includes overview of the roles and responsibilities of the film director, examples of film directing, and practice sessions in analyzing a script, creating a scene, working with actors, conducting rehearsals, planning the camera movements and overseeing elements of a production. Prerequisites: (TCM120 and TCM215) or permission of instructor.

TCM240 **3 credits** **3 periods**
Advanced Television Production

Advanced workshop in television production. Emphasis on directing techniques, working with a crew, shooting and sound. Uses small production teams to shoot for short pieces. Prerequisites: TCM180 or TCM215, or permission of instructor.

TCM241 **4 credits** **6 periods**
Introduction to Non-Linear Editing

Introduction to editing on a non-linear editing system. Prerequisites: TCM136 or permission of instructor.

TCM241AA **4 credits** **6 periods**
Introduction to Non-Linear Editing: AVID

Introduction to editing on a non-linear editing system. Prerequisites: TCM136 or permission of instructor.

TCM241AB **4 credits** **6 periods**
Introduction to Non-Linear Editing: Final Cut Pro

Introduction to editing on a non-linear editing system. Prerequisites: TCM136 or permission of instructor.

TCM242 **2 credits** **2 periods**
Portfolio Non-Linear Editing

Explores techniques and applications used in editing an individual project on a non-linear editing system. Prerequisites: TCM241 or TCM241AA or TCM241AB and independent footage. *Course Note: May be repeated for a total of six (6) credits.*

TCM243 **4 credits** **6 periods**
Introduction to Video Compositing and Title Animation

Introduction to computer-based video compositing and title animation. Prerequisites: ART177 and (TCM241 or TCM241AA or TCM241AB) or permission of instructor.

TCM245 **4 credits** **6 periods**
Advanced Motion Picture Production

Advanced workshop in the production of the short narrative. Uses small production teams to pre-produce and shoot narrative movies on either film or digital platforms. Emphasizes the aesthetics and technical elements of scriptwriting, directing actors, directing crew, pre-production, camera and sound equipment operation, lighting, cinematography, production sound and final production. Prerequisites: (TCM120 and TCM215) or permission of instructor.

TCM250 **4 credits** **8 periods**
Documentaries for Social Change

Study of and practical application in social documentary production. Focuses on diverse voices and styles of social documentaries, philosophical issues faced by the social documentary filmmaker, technical considerations in making a social documentary, and business elements required for financial and commercial success of the social documentary. Students view diverse social documentaries, participate in a variety of social documentary camera and sound exercises, complete an individual social documentary project on film and/or digital, and create a business proposal for their project. Prerequisites: TCM241, or TCM241AA, or TCM241AB, or permission of instructor.

TCM251 **3 credits** **5 periods**
Advanced Studio Production

Advanced video production within a studio environment. Prerequisites: TCM151 and TCM219, or permission of instructor. *(TCM251 not offered every semester.)*

TCM260 **3 credits** **3 periods**
Film/Video Producing and Financing

Guides the independent film/video producer through basic business aspects of production. Examines methods of setting up a production company, strategies for financing and distribution and approaches to packaging a film/video project. Includes development of a prospectus on a special film/video project. Prerequisites: None.

TCM271 **4 credits** **6 periods**
Advanced Non-Linear Effects and Compositing

Advanced non-linear techniques for effects and compositing creation. Prerequisites: (TCM241AA and TCM242) or permission of instructor.

TCM280 **3 credits** **5 periods**
The Art of Editing

Analysis of the art of editing movie and television media, including technique, pacing, and style. Development of editing skills using instructor provided footage. Prerequisites: TCM241, or TCM241AA, or TCM241AB. *Course Note: May be repeated for a total of nine (9) credits.*

TCM282 **4 credits** **6 periods**
Advanced Non-Linear Editing Techniques

Explores techniques and advanced applications used in creating and editing an advanced project on a non-linear editing system. Prerequisites: (TCM241AA and TCM242) or permission of instructor. *(TCM282 not offered every semester.)*

TCM282AA **4 credits** **6 periods**
Advanced Non-Linear Editing Techniques: AVID

Explores techniques and advanced applications used in creating and editing an advanced project on a non-linear editing system. Prerequisites: (TCM241AA and TCM242) or permission of instructor. *(TCM282AA not offered every semester.)*

Course Descriptions

TCM282AB 4 credits 6 periods
Advanced Non-Linear Editing Techniques: Final Cut Pro
 Explores techniques and advanced applications used in creating and editing an advanced project on a non-linear editing system. Prerequisites: (TCM241AB and TCM242) or permission of instructor. *(TCM282AB not offered every semester.)*

TCM285AA-AC 1-3 credits 1-3 periods
Special Topics: Motion Picture/Television Production
 Exploration of current topics, issues and aspects of motion picture and television production. Prerequisites: TCM136 or permission of instructor.
Course Note: May be repeated for a total of three to nine credits.

TCM296 - COOPERATIVE EDUCATION: Information about TCM296 courses can be found on page 142.

TCM298 - SPECIAL PROJECTS: Information about TCM298 courses can be found on page 203.

MUSIC

Music Department Office MB 137 (480) 423-6333
 Fine Arts Division Office MB 139 (480) 423-6328

Scottsdale Community College offers the first two years of basic instruction needed for theory, voice and/or instrumental majors. In addition, courses are offered to meet the requirements of general education in the humanities, commercial music and special interest areas. Private instruction is offered in the areas of piano, voice, band and orchestral instruments. A special fee is charged for private instruction, except for approved music majors. Music majors are required to participate in a performance group each semester. All potential music majors are encouraged to contact the music department, (480) 423-6333, for further information.

MHL Music: History & Literature

MHL140 3 credits 3 periods
Survey of Music History
 Study of composers, compositions, styles, and periods in music history. Prerequisites: None.

MHL145 3 credits 3 periods
American Jazz and Popular Music
 The study of cultural and social contributions to the evolution of American jazz and popular music from the mid-1800s to present. Prerequisites: None.

MHL153 3 credits 3 periods
Rock Music and Culture
 History of rock music and how cultural, social, political, and economic conditions have shaped its evolution. Prerequisites: None.

MTC Music: Theory & Composition

MTC101 3 credits 3 periods
Introduction to Music Theory
 Designed to develop written and aural skills necessary for advanced study of music theory and skills. Recommended for music majors. Prerequisites: None.

MTC103 2 credits 2 periods
Introduction to Aural Perception
 An introduction to the aural skills necessary to hear relationships of intervals, rhythms, melody, and harmony in music. May be repeated for a total of four (4) credit hours. Prerequisites: None.

MTC105 3 credits 3 periods
Music Theory I
 The chronological study of music theory including: harmony, melody, texture, structure and timbre through analysis, original compositions and basic exercises to demonstrate musical concepts. Prerequisites: MTC100, or MTC101, or permission of instructor. Corequisites: MTC106.

MTC106 1 credit 2 periods
Aural Perception I
 The development of listening and performing skills through dictation, sight singing and keyboard harmony. Prerequisites: None. Corequisites: MTC105.

MTC120 3 credits 5 periods
Introduction to Sound Design for Film and Video (TCM120)
 Basic principles of recording and mixing sound for film and video. Includes voice-over, automatic dialog replacement (ADR), foley, ambience, special effects and music. Emphasis on analog and digital recording techniques in the field as well as in a controlled environment. Prerequisites: (TCM100 and TCM136) or permission of instructor.

MTC155 3 credits 3 periods
Music Theory II
 A continuation of Music Theory I with emphasis on harmony and part-writing procedures. Prerequisites: MTC105. Corequisites: MTC156.

MTC156 1 credit 2 periods
Aural Perception II
 A continuation of Aural Perception I, including harmonic practices. Prerequisites: None. Corequisites: MTC155.

MTC190 3 credits 4 periods
Computer-Aided Music Notation
 Introduction to computer-aided music notation, culminating in editing and producing publication-quality music scores. Ability to read music notation required. Prerequisites: Permission of instructor.

MTC191 3 credits 4 periods
Electronic Music I
 An introduction to producing music with Musical Instrument Digital Interface (MIDI) configurations consisting of computers, printers, synthesizers, and other compatible MIDI instruments. Prerequisites: None.

MTC192 3 credits 4 periods
Electronic Music II
 Continued study of the production of music with Musical Instrument Digital Interface (MIDI) configurations. Emphasis on more complex configurations and their applications in song arrangements. Prerequisites: MTC191.

Course Descriptions

MTC205 **3 credits** **5 periods**
Music Theory III
 The study of chromatic harmony and melody, modulation techniques and expanded chords. The analysis of formal structure. Prerequisites: MTC155. Corequisites: MTC206. (*MTC205 not offered every semester.*)

MTC206 **1 credit** **2 periods**
Aural Perception III
 A development of listening and performing skills, including an introduction of chromatic harmonic techniques and concepts of style. Prerequisites: None. Corequisites: MTC205. (*MTC206 not offered every semester.*)

MTC220 **3 credits** **3 periods**
Advanced Sound Design for Film and Video (TCM220)
 Explores techniques and advanced applications used in designing sound using original student footage on a non-linear editing system. Prerequisites: MTC/TCM120 or permission of instructor. (*MTC220 not offered every semester.*)

MTC255 **3 credits** **3 periods**
Music Theory IV
 A continuation of Music Theory III, including 20th Century theories and techniques. Prerequisites: MTC205. Corequisites: MTC256. (*MTC255 not offered every semester.*)

MTC256 **1 credit** **2 periods**
Aural Perception IV
 A continuation of Aural Perception III, including extended chords. Prerequisites: None. Corequisites: MTC255. (*MTC256 not offered every semester.*)

MTC261 **3 credits** **3 periods**
Modern Arranging I
 Basic arranging techniques as used in jazz and rock idioms for combo and special ensembles. Idiomatic uses of harmony, melodic rhythm, voicing, tonal color and notation. May be repeated for a total of six (6) credit hours. Prerequisites: MUP164 and MUP165, or permission of instructor.

MTC296 - COOPERATIVE EDUCATION: Information about MTC296 courses can be found on page 142.

MTC298 - SPECIAL PROJECTS: Information about MTC298 courses can be found on page 203.

MUC Music: Commercial & Business

MUC109 **3 credits** **3 periods**
Music Business: Merchandising and the Law
 Operation, scope, and career opportunities in the music business. Focuses on music in the marketplace, songwriting, publishing, copyright procedures and business affairs, agents, artist management, and concert production. Prerequisites: None. (*MUC109 not offered every semester.*)

MUC110 **3 credits** **3 periods**
Music Business: Recording and Mass Media
 Operation, scope, and career opportunities in the music business. Focuses on the record industry; environmental music; uses of music in radio, telecommunications, and film; and career options. Prerequisites: None. (*MUC110 offered in the Spring semester only.*)

MUC111 **3 credits** **5 periods**
Digital Audio Workstation I (DAW I)
 Use of digital mixing and automation software in conjunction with editing and recording. Includes computer operation, troubleshooting, and file management. Prerequisites: MUC195 or MUC195AA.

MUC112 **3 credits** **5 periods**
Digital Audio Workstation II (DAW II)
 Use of digital mixing and automation software in conjunction with editing and recording. Includes computer operation, troubleshooting, and file management. Prerequisites: MUC111.

MUC135 **2 credits** **2 periods**
Live-Performance Disc Jockey Techniques
 Development of beginning level live-performance disc jockey techniques. Emphasis on understanding the construction of industry-formatted dance songs, cueing, segueing/mixing methods, the relationship of beats per minute to segueing, and programming songs to entertain a live audience. Covers the history of the live performance DJ and strategies for soliciting employment in the field. Prerequisites: None.

MUC195AA **3 credits** **5 periods**
Studio Music Recording I
 Basic principles of studio sound recording. Emphasis on musical acoustics, operation of recording equipment, studio setups, and multitrack recording. Includes studio session process and musical production decisions. Prerequisites: None.

MUC196AA **3 credits** **5 periods**
Studio Music Recording II
 Emphasis on signal-processing equipment, mixing consoles and advanced musical recording session procedures, production, and engineering. Includes mix-down and resultant master tape of a musical recording session. Prerequisites: MUC195 or MUC195AA.

MUC197 **3 credits** **3 periods**
Live Sound Reinforcement I
 Basic principles of live sound engineering. Emphasis on signal flow, acoustic, sound reinforcement set-ups and installation, signal processing, microphone selections and placement. Includes setting up sound systems and mixing live music. Prerequisites: None.

MUC198 **3 credits** **3 periods**
Live Sound Reinforcement II
 Emphasis on musical production decisions. Front-of-house and monitor console placement, loudspeaker arrangements, power considerations, program material and sound pressure levels. Includes setting up of sound system and mixing live performances with various styles of music. In addition to mixing at alternate locations. Prerequisites: MUC197. (*MUC198 not offered every semester.*)

MUC295 **3 credits** **6 periods**
Studio Music Recording III
 Producing and engineering a recording project. Covers how recording studios work and how recording projects are organized from pre-production through delivery of the final mix. Prerequisites: (MUC195 or MUC195AA) or MUC196 and instructor approval.

Course Descriptions

MUP Music: Private Instruction

There is a special fee for non-music majors enrolling in private instruction of \$280 for 1 credit (1/2 hour lesson per week, per semester) or \$560 for 2 credits (1 hour lesson per week, per semester) in addition to the regular credit fee. Private instruction emphasizing musicianship, literature, technique and performance. Four course sequence designed for university transfer equivalency. Instruction provided on voice, piano, harpsichord, organ, guitar, trumpet, French horn, trombone, baritone horn, tuba, flute, oboe, clarinet, bassoon, saxophone, violin, viola, violoncello, contrabass, bass guitar, percussion and harp. May be repeated for credit.

MUP101	Private Instr.	(1/2 hour lesson 1 credit)	1st Semester
MUP151	Private Instr.	(1/2 hour lesson 1 credit)	2nd Semester
MUP201	Private Instr.	(1/2 hour lesson 1 credit)	3rd Semester
MUP251	Private Instr.	(1/2 hour lesson 1 credit)	4th Semester
MUP102	Private Instr.	(1 hour lesson 2 credits)	1st Semester
MUP152	Private Instr.	(1 hour lesson 2 credits)	2nd Semester
MUP202	Private Instr.	(1 hour lesson 2 credits)	3rd Semester
MUP252	Private Instr.	(1 hour lesson 2 credits)	4th Semester

MUP Music: Performance

MUP131 **2 credits** **3 periods**

Class Piano I

Development of beginning piano techniques and the fundamentals of music including basic hand position, music reading skills of melodic and harmonic material, major scales, transposition, and harmonizations including the I, IV, V7 chords. Prerequisites: None.

MUP132 **2 credits** **3 periods**

Class Piano II

Continuation of Piano I with emphasis on elementary piano techniques including major and minor scales, transposition, improvisation, and sight reading. Prerequisites: MUP131 or permission of instructor.

MUP133 **2 credits** **3 periods**

Class Voice I

Introduction to the fundamentals of vocal production. Emphasis on breathing techniques, tone production and performances in class of solo vocal literature. Prerequisites: None.

MUP134 **2 credits** **3 periods**

Class Voice II

Continuation of Class Voice I including the elements of stage presence and diction. Prerequisites: MUP133 or permission of instructor.

MUP135 **2 credits** **3 periods**

Class Native American Flute I

Practical class with emphasis on playing, including embouchure, breath control, finger control, reading from printed score and improvising songs. May be repeated for up to six (6) credits. Prerequisites: None.

MUP150 **1 credit** **3 periods**

Community Chorus

A mixed chorus with emphasis on college/community participation and preparation of a variety of choral literature for public performance. Auditions may be required. May be repeated for credit. Prerequisites: None.

MUP153 **2 credits** **5 periods**

A Cappella Choir

A mixed choir designed to emphasize choral techniques and performance of all styles of choral literature. Public performances are scheduled during the year including a concert tour. Auditions may be required. May be repeated for credit. Prerequisites: None.

MUP154AB **2 credit** **5 periods**

Jazz Vocal Ensemble

Practical and performing experience in vocal jazz. Includes music from the 1920's through the present. Requires participation in various public performances on campus and in the community throughout the semester. May be repeated for up to six (6) credits. Prerequisites: Auditions required and two semesters in A Cappella Choir or permission of instructor.

MUP159 **1 credit** **3 periods**

Community Orchestra

Emphasis on college/community participation and the preparation of orchestral literature for public performance. Auditions may be required. May be repeated for credit. Prerequisites: None.

MUP161 **1 credit** **3 periods**

Community Band

Emphasis on college/community participation and the preparation of band literature for public performance. Auditions may be required. May be repeated for credit. Prerequisites: None.

MUP163 **1 credit** **3 periods**

Jazz Ensemble

Practical and performance experience in various jazz styles. Open to all students on the basis of auditions. May be repeated for credit. Prerequisites: None.

MUP164 **2 credits** **3 periods**

Jazz Improvisation I

Theoretical and performance skills in many styles of jazz improvisation. May be repeated for a total of six (6) credit hours. Prerequisites: None.

MUP181 **1 credit** **2 periods**

Chamber Music Ensembles

Practical and performance experience in instrumental, vocal, and mixed ensembles. May be repeated for credit. Prerequisites: None.

MUP225 **2 credits** **3 periods**

Class Guitar I

Emphasis on note-reading and folk-style harmonic accompaniment. Includes finger-style playing. Stresses development of efficient practice techniques and proper sitting and hand positions. Prerequisites: None.

Course Descriptions

MUP226 2 credits 3 periods
Class Guitar II
Note-reading range including second position and parts of higher positions. Classical, popular, Latin, and other styles of music. Theory including scales, keys, and chord construction. Technical exercises of both hands. Prerequisites: MUP225 or permission of instructor.

MUP227 2 credits 3 periods
Class Guitar III
Additional fingerboard positions. Ensemble techniques and performance. Prerequisites: MUP226 or permission of instructor.

MUP228 2 credits 3 periods
Class Guitar IV
Advanced fingerboard positions. Duet and trio performances. Advanced ensemble techniques. Prerequisites: MUP227 or permission of instructor.

MUP231 2 credits 3 periods
Class Piano III
Development of intermediate piano techniques including selected solo literature, transposition of harmonic patterns, and secondary dominants. Prerequisites: MUP132 or permission of instructor.

MUP232 2 credits 3 periods
Class Piano IV
Continuation of Piano III including modulation techniques, improvisation of piano accompaniments, advanced chromatic harmony, and sight reading of advanced literature. Prerequisites: MUP231 or permission of instructor.

MUP233 2 credits 3 periods
Class Voice III
Interpretive singing through a closer examination of coloring, tone production, dynamics, and tempo indications. Prerequisites: MUP134.

MUP234 2 credits 3 periods
Class Voice IV
Emphasis on the preparation of solo vocal literature for the purpose of evaluation and the integration of the music with the drama of the music. Prerequisites: MUP233 or permission of instructor.



MUP270 2 credits 5 periods
Musical Theatre Workshop (THP270)
Workshop in the study and performance of Musical Theatre repertoire including audition techniques, talent evaluation criticism, rehearsal techniques, vocal acting styles, stage movement, and performance. May be repeated for credit. Prerequisites: None.

MUP285AA 3 credits 6 periods
Multimedia Performance Ensemble I (DAN285AA)
Provides students with opportunities to gain training in one or more aspects of arts and entertainment including dance technology and performance, music production and performance and other aspects of live performance production. Assigned projects may be individualized and/or a group effort. Emphasis on developing professional skills of students in their particular area/s of specialization through practical experience and interaction with industry professionals and development of student performance portfolios. Prerequisites: Permission of instructor.

MUP285AB 3 credits 6 periods
Multimedia Performance Ensemble II (DAN285AB)
Provides students with opportunities to gain training in one or more aspects of arts and entertainment including dance technology and performance, music production and performance and other aspects of live performance production. Assigned projects may be individualized and/or a group effort. Emphasis on developing professional skills of students in their particular area/s of specialization through practical experience and interaction with industry professionals and development of student performance portfolios. Prerequisites: Permission of instructor.

MUP285AC 3 credits 6 periods
Multimedia Performance Ensemble III (DAN285AC)
Provides students with opportunities to gain training in one or more aspects of arts and entertainment including dance technology and performance, music production and performance and other aspects of live performance production. Assigned projects may be individualized and/or a group effort. Emphasis on developing professional skills of students in their particular area/s of specialization through practical experience and interaction with industry professionals and development of student performance portfolios. Prerequisites: Permission of instructor.

MUP285AD 3 credits 6 periods
Multimedia Performance Ensemble IV (DAN285AD)
Provides students with opportunities to gain training in one or more aspects of arts and entertainment including dance technology and performance, music production and performance and other aspects of live performance production. Assigned projects may be individualized and/or a group effort. Emphasis on developing professional skills of students in their particular area/s of specialization through practical experience and interaction with industry professionals and development of student performance portfolios. Prerequisites: Permission of instructor.

MUP298 - SPECIAL PROJECTS: Information about MUP298 courses can be found on page 203.

Course Descriptions

NURSING: CONTINUING EDUCATION **NCE**

Health Sciences Division Office SB 132 (480) 423-6225

The college offers selected continuing education courses designed to update the practicing nurse's skills and competencies, to upgrade those already employed as health care givers or to enhance knowledge gained in the basic nursing education program.

NCE214MI **0.5 credit 0.5 period** **Math and Medications for Intermediate Nursing Students**

Focus on basic mathematical concepts to calculate metric-apothecary conversion, dosage problems, intravenous flow rates using the ratio/proportion and dimensional analysis methods. These calculations will focus application to acute care, long-term care, and pediatric specialty areas. Prerequisites: A grade of C or better in NUR161, NUR163, NUR167, NUR169, HCR240AA, and FON241.

NCE214MM **1 credit 1 period** **Mathematical Methods of Drug Calculation**

Focuses on basic mathematical concepts using decimals and fractions to calculate fractional and metric-apothecary conversion dosage problems and intravenous flow rates. Emphasis on the dimensional analysis problem solving method. Prerequisites: None.

NCE214OP **1 credit 1 period** **Orientation to Nursing Program**

Overview of the philosophy, core values, policies, competencies and curricular components of the Maricopa Community College District Nursing Program. Basic concepts of therapeutic communication, normal growth and development, the nursing process, pharmacology, metrology, and concepts of intravenous therapy. Emphasis on the use of the nursing process, utilization of critical thinking skills, sound decision-making principles in the clinical setting, the communication process, time management and stress reduction, and the transition in role expectations between Licensed Practical Nurse (LPN) and Registered Nurse (RN). Review and evaluation of Practical Nursing skills included. Prerequisites: Advanced placement into the Nursing program. *Course Note: Designed for transfer students, returning students and Practical Nurses entering the District Program.*

NURSING SCIENCE **NUR**

Health Sciences Division Office SB 132 (480) 423-6225

The Nursing Program is available at eight of the Maricopa Community Colleges. The nursing pathway provides multiple exit points for employment that begins with the Nurse Assisting course and continues to the Practical Nurse certificate and Registered Nurse degree program.

NUR104AB **1 credit 1 period** **Structured Nursing Review**

Structured nursing tutorial assistance and nursing skills to help students achieve success in their respective block of nursing courses. Nursing process and critical thinking application skills emphasized. Course offered as Credit (P) No credit (Z) basis. May be repeated for a total of six (6) credit hours. Prerequisites: None. Corequisites: Concurrent enrollment in the Nursing program or permission of Department Chair.

NUR156 **2 credits 2 periods** **Nurse Assisting**

Role of the nursing assistant for clients across the wellness/illness continuum within the nurse assisting scope of practice. Introduction to problem solving process specific to meeting the basic and holistic needs of clients. Professional communication skills essential for the nursing assistant. Nursing interventions to ensure the needs and safety of the client. Specific types of diseases, conditions and alterations in behavior of the client. Principles of nutrition and fluid balance. Special needs of the elder client in the acute and long-term care settings. Basic emergency care skills and procedures. NUR156 and NUR157 must be successfully completed concurrently to meet program requirements. Prerequisites or Corequisites: [HCC130 or (HCC130AA, HCC130AB, HCC130AC, HCC130AD, HCC130AE, and HCC130AF)] and HCC145AA, or equivalent. Corequisites: NUR157.

NUR157 **2 credits 6 periods** **Nurse Assisting Lab**

Demonstration of problem solving, professional behavior and therapeutic communication skills. Demonstration of caring behaviors and ensuring environmental safety for the client. Provides opportunity for the development of clinical competency in the performance of selected nursing assisting skills and procedures through participation in the care of clients. NUR156 and NUR157 must be successfully completed concurrently to meet program requirements. Prerequisites: Completed Health and Safety Documentation Checklist (Proof of immunity or immunizations for Rubella, Rubeola, Mumps, Varicella, Hepatitis B, current TB testing, and current Health Care Provider CPR card) and completed Health Declaration form. Corequisites: NUR156.

NUR111 **4 credits 4 periods** **Nursing Process and Critical Thinking I**

Overview of nursing and critical thinking strategies focused on meeting basic human needs within the wellness/illness continuum. Theoretical concepts related to holistic care of well, geriatric, and adult clients with selected alterations in health including psychological/mental health disorders. Emphasis on use of nursing process in the role of the nurse as member of the health care team. Includes concepts of pathophysiology, nutrition, and communication. Requires application of previous knowledge of physical, biological, and social sciences. Prerequisites: Admission to the Practical Nursing or Nursing programs. Corequisites: NUR119 or permission of Nursing Department chairperson.

NUR117 **2 credits 4 periods** **Pharmacology/Medication Administration I**

Introduction to pharmacology. Includes foundation knowledge and skills instruction. Emphasis on core medication prototypes and skills necessary for safe administration of selected medication categories. Concepts of medication administration by selected routes introduced. Application of previous knowledge of physical, biological and social sciences. Prerequisites: Admission to the Practical Nursing or Nursing Programs.

Course Descriptions

NUR119 5 credits 15 periods

Nursing Science I

Development of clinical competency in the performance of selected nursing skills and procedures. Provides for participation in the care of clients experiencing problems of alteration in health and selected mental health disorders. Provides for clinical practice experiences with individuals and families in a variety of long term care and acute settings. Application of holistic nursing concepts and assessments related to health promotion, disease/illness prevention, and health restoration, as well as concepts of pathophysiology, nutrition, and communication. Prerequisites: Admission into the Practical Nursing or Nursing Programs. Corequisites: NUR111 or permission of Nursing Department chairperson.

NUR121 4 credits 4 periods

Nursing Process and Critical Thinking II

Nursing and critical thinking strategies focused on meeting basic human needs within the wellness/illness continuum. Theoretical concepts related to holistic care of adult and geriatric clients with selected alterations in health. Introduces human growth and developmental principles. Introduction to care of newborn, pediatric, well childbearing clients, and childrearing families. Continuation of the role of the nurse as member of the health care team. Includes concepts of pathophysiology, nutrition, and communication. Application of previous knowledge of physical, biologic, social, and nursing sciences. Prerequisites: NUR111, NUR117, and NUR119. Corequisites: NUR129 or permission of Nursing Department chairperson.

NUR127 2 credits 2 periods

Pharmacology/Medication Administration II

Continues emphasis on core medication prototypes and skills. Emphasis on critical thinking skills for safe practice in medication administration. Introduces concepts of venipuncture and initiation of IV access. Requires application of previous knowledge of physical, biological, social and nursing sciences. Prerequisites: NUR111, NUR117, and NUR119.

NUR129 5 credits 15 periods

Nursing Science II

Continuation of application of holistic nursing concepts and assessments related to health promotion, disease/illness prevention and health restoration of individuals and families. Provides continued opportunity for the development of clinical competency in the performance of selected nursing skills, participation in the care of clients with alterations in health. Provides clinical experiences with adult, pediatric, well childbearing clients and childrearing families in a variety of acute care and community settings. Application of nursing concepts in the development of care plans as well as concepts of pathophysiology, nutrition, and communication. Includes participation in client teaching and discharge planning. Prerequisites: NUR111, NUR117, and NUR119. Corequisites: NUR121 or permission of Nursing Department chairperson.

NUR181 3 credits 3 periods

Nursing Process and Critical Thinking II

Focus on nursing concepts and theories to meet basic human needs across the life span based on the wellness/illness continuum. Emphasis on the nursing process related to pediatric and adult clients with selected alterations in health. Introduction to care of the well childbearing client and childbearing

family. Continuation of the role of the practical nurse in planning nursing care and applying established nursing diagnoses for clients. Emphasis on the utilization of critical thinking processes related to nursing care of clients in acute care and community settings. Nursing Process/Critical Thinking course and Nursing Science course must be successfully completed concurrently to meet program requirements. Prerequisites: NUR161, NUR163, NUR169, and (HCR240 or HCR240AA). Corequisites: NUR189 or permission of Nursing Department chairperson.

NUR185 1 credit 1 period

Developing the Nurse's Role I

Overview of roles in nursing with emphasis on transition from nursing assistant to practical nurse. Includes introduction of the core values of the MCCD nursing programs, nursing history, standards, and scope of practice. Introduces concepts and skills required of the practical nurse, and application of communication techniques and delegation to teamwork and leadership. Prerequisites: NUR161, NUR163, NUR167, NUR169, and admission into the nursing program.

NUR187 1.5 credits 1.5 periods

Pharmacology/Medication Administration II

Overview of selected drug classifications and categories. Emphasis on principles of drug metabolism and effects, interactions and adverse reactions, and nursing implications for safe practice. Requires application of previous knowledge of physical, biological, and social sciences. Prerequisites: (HCR240 or HCR240AA), NUR161, NUR163, NUR167, and NUR169.

NUR189 4 credits 12 periods

Nursing Science II

Continued application of holistic nursing concepts and theories related to health promotion, disease/illness prevention and health restoration of individuals and families. Provides continued opportunity for the development of clinical competency in the performance of selected nursing skills, participation in the care of clients across the life span including clients with alterations in health. Provides experiences with individuals, families, and small groups of clients in a variety of acute care and community settings. Application of nursing concepts and theories related to the development of care plans, client teaching and discharge planning. Nursing Process/Critical Thinking course and Nursing Science course must be successfully completed concurrently to meet program requirements. Prerequisites: NUR161, NUR163, NUR169, and (HCR240 or HCR240AA). Corequisites: NUR181 or permission of Nursing Department chairperson.

NUR231 4 credits 4 periods

Nursing Process and Critical Thinking III

Nursing and critical thinking strategies. Emphasis on complex human needs within the wellness/illness continuum in a variety of acute care and community settings. Theoretical concepts related to holistic care of adults with selected acute and chronic alterations in health and psychiatric/mental health disorders. Introduction to role of the professional nurse as member of the health care team. Integrates concepts of nutrition, communication, health promotion, and advanced pathophysiology. Application of previous knowledge of physical, biologic, social, and nursing sciences. Prerequisites: NUR121, NUR127, and NUR129. Corequisites: NUR239 or permission of Nursing Department chairperson.

Course Descriptions

NUR237 1 credit 2 periods

Pharmacology/Medication Administration III

Knowledge and skills to safely prepare and administer intravenous medications and solutions. Emphasizes management of clients receiving complex therapies such as blood and blood products, parenteral nutrition, and advanced pain management. Application of previous knowledge of physical, biological, and social sciences. Includes an overview of parenteral medications and therapies used in selected situations. Prerequisites: NUR121, NUR127, and NUR129.

NUR239 5 credits 15 periods

Nursing Science III

Application of critical thinking skills through the nursing process to clients and families with acute alterations in health and psychiatric/mental health disorders. Provides for the development of clinical and cultural competency and the continued development of selected nursing skills and procedures within the nursing scope of practice. Holistic care of clients, families, and small groups in a variety of acute and community health care settings. Application of nursing concepts related to health education/promotion for clients, families, and small groups. Integrates concepts of nutrition, communication, health promotion and advanced pathophysiology. Prerequisites: NUR121, NUR127, and NUR129. Corequisites: NUR231 or permission of Nursing Department chairperson.

NUR241 4 credits 4 periods

Nursing Process and Critical Thinking IV

Nursing and critical thinking strategies for complex holistic needs of high-risk clients with multi-system health alterations. Includes perinatal, newborn, pediatric, and adult clients in acute care settings. Continuation of role development of the professional nurse. Integrates concepts of nutrition, communication, health promotion, and advanced pathophysiology. Application of previous knowledge of physical, biologic, social, and nursing sciences. Prerequisites: NUR231, NUR237, and NUR239. Corequisites: NUR249 or permission of Nursing Department chairperson.

NUR249 6 credits 18 periods

Nursing Science IV

Synthesis of nursing concepts. Provides nursing care for high-risk newborn, pediatric, perinatal, and adult clients with multi-system alterations in health. Emphasis on leadership and management roles of the nurse. Includes a preceptorship experience to facilitate role transition from student to graduate nurse. Integrates concepts of nutrition, communication, health promotion and advanced pathophysiology. Prerequisites: NUR231, NUR237, and NUR239. Corequisites: NUR241 or permission of Nursing Department chairperson.

NUR261 3 credits 3 periods

Nursing Process and Critical Thinking III

Focus on nursing concepts and theories to meet complex basic human needs across the life span based on the wellness/illness continuum in a variety of acute care and community settings. Emphasis on utilizing critical thinking skills to plan holistic care through the nursing process for groups of clients with selected acute and chronic alterations in health and psychiatric/mental health disorders. Nursing Process/Critical Thinking course and Nursing Science course must be successfully completed concurrently to meet program requirements. Prerequisites: [NUR181, NUR185, NUR187, NUR189 and (HCR240 or HCR240AB)] or Integrated Competency Assessment Network (ICAN) placement. Corequisites: NUR269 or permission of Nursing Department chairperson.

NUR263 1 credit 3 periods

Health Assessment and Health Promotion II

Use of advanced, specialized, and holistic assessments to restore optimal wellness for clients across the life span. Emphasis on active involvement and use of resources, risk reduction, prevention, and education strategies and programs for client, family, and community. Requires application of previous knowledge of physical, biological, and social sciences. Prerequisites: (NUR181, NUR185, NUR187 and NUR189) and [HCR240 or (HCR240AA and HCR240AB)]. NCE214OP required for advanced placement students.

NUR267 1 credit 2 periods

Pharmacology/Medication Administration III

Provides the knowledge and skills to safely prepare and administer intravenous medications and solutions. Emphasizes management of clients receiving complex therapies such as blood and blood products, parenteral nutrition, and advanced pain management. Requires application of previous knowledge of physical, biological, and social sciences. Includes an overview of medications used in selected client situations with emphasis on pharmacokinetics, safe preparation and administration, monitoring and documentation of client responses. Prerequisites: (NUR181, NUR185, NUR187 and NUR189) and [HCR240 or (HCR240AA and HCR240AB)]. NCE214OP required for advanced placement students.

NUR269 5 credits 15 periods

Nursing Science III

Application of critical thinking skills through the nursing process to clients and families with acute alterations in health and psychiatric/mental health disorders. Provides for the development of clinical and cultural competency and the continued development of selected nursing skills and procedures within the scope of the professional nurse. Holistic care of clients, families, and small groups in a variety of acute and community health care settings. Application of professional nursing concepts and theories related to health education/promotion for clients, families, and small groups. Nursing Process/Critical Thinking course and Nursing Science course must be successfully completed concurrently to meet program requirements. Prerequisites: NUR181, NUR185, NUR187, NUR189, (HCR240 or HCR240AB or NCE214OP), or Integrated Competency Assessment Network (ICAN) placement. Corequisites: NUR261 or permission of Nursing Department chairperson.

NUR281 3 credits 3 periods

Nursing Process and Critical Thinking IV

Emphasis on nursing concepts and theories to meet complex needs of the critically ill and high-risk clients with multiple system alterations in health. Includes high-risk perinatal, pediatric, and adult clients in acute care and community settings. Focus on application of critical thinking skills to modify a holistic plan of care. Highlights the role of the professional nurse in health education/promotion, illness prevention, and restorative care. Nursing Process/Critical Thinking course and Nursing Science course must be successfully completed concurrently to meet program requirements. Prerequisites: (NUR261, NUR263, NUR267, and NUR269) or NCE214OP or Integrated Competency Assessment Network (ICAN) placement. Corequisites: NUR289 or permission of Nursing Department chairperson.

Course Descriptions

PED210WH 1 credit 3 periods
Movement Analysis: Tennis
 Practical application of biomechanical, physiological, psychological and teaching/learning principles in the analysis of skill acquisition and performance. Prerequisites: None.

PED210WT 1 credit 3 periods
Movement Analysis: Volleyball
 Practical application of biomechanical, physiological, psychological and teaching/learning principles in the analysis of skill acquisition and performance. Prerequisites: None.

PED241 3 credits 3 periods
History of Sports in the United States
 Traces the development of sports in the United States. Explores the heritage of major sports and reviews significant historical and current issues related to sports in America. Prerequisites: None.

PED265 3 credits 3 periods
Theory of Coaching
 Discusses the impact of sports on the American culture, legal liabilities of coaching, principles of a coaching philosophy, the role of teaching skill, physical conditioning and nutrition in coaching, components of team/group psychology and dynamics, motivation and aggression in sport. Prerequisites: None. *PED281, suggested but not required. (Offered for baseball, basketball, golf, soccer, softball, tennis and volleyball.)*

PED270 2 credits 2 periods
Teaching Yoga: Level I
 Methods of teaching yoga. Studies assessment techniques, establishing goals, and organizing the classroom. Reviews yoga instruction techniques and how these differ from other movement-based activities; application of anatomical knowledge and practice teaching experiences. Prerequisites: PED101YJ or PED102YJ or PED201YJ or PED202YJ.

PED271 2 credits 2 periods
Teaching Yoga: Level II
 Emphasizes practice teaching experiences. Reviews instructional methods and techniques for assessing student skill levels, organizing the classroom and writing lesson plans; application of anatomical knowledge to build movement skills, improvement of observational skills and development of an individual teaching style. Prerequisites: PED270 or permission of instructor.

PED272 2 credits 2 periods
Teaching Yoga: Alignments and Adjustments
 Instructional methods for teaching more advanced asanas. Principles of alignment of back bending, inversion, forward bending and arm balancing asanas and techniques for identifying and correcting misalignments. Emphasis on instructional techniques that safely build yoga movement skills while encouraging progression in the practice of challenging asanas. Prerequisites: PED271 or permission of instructor.

PED274 1 credit 3 periods
Teaching Yoga: Practicum
 Guided, practical, in-class experience in teaching yoga students. Requires implementation of lesson plans, application of individual teaching techniques, demonstration of individual teaching style, and evaluation of teaching sessions. Prerequisites: PED270 or PED271.

PED280 2 credits 2 periods
Introduction to Yoga Therapy I
 Introduction to the therapeutic use of yoga. Includes basic concepts of yoga therapy, identification of common therapeutic problems and application of yoga asana as a modality of healing. Demonstration and practice of therapeutic techniques and sequences to improve movement and promote health and well-being. Prerequisites: PED270 or permission of instructor.

PED281 3 credits 3 periods
Methods of Coaching
 Techniques, methods and procedures of coaching. May not be repeated for credit. Prerequisites: None. (*Offered for baseball, football, soccer, softball, and volleyball.*)

PED282 2 credits 2 periods
Introduction to Yoga Therapy II
 Basic concepts of yoga therapy, review of therapeutic interventions, identification of common therapeutic problems, and application of yoga asana as a modality of healing. Demonstration and practice of therapeutic techniques and sequences to improve movement capability and promote health and well-being. Emphasis on the study of chronic problem areas and therapeutic issues. Prerequisites: PED280 or permission of instructor.

Fitness and Wellness Center Aerobics and Weight Training

The Fitness and Wellness Center helps students and public develop a lifestyle of regular exercise. Physical conditioning classes consist of the use of strength and aerobic equipment for special work on isolated body areas and the cardiovascular system. Structured aerobic classes are held mornings and evenings. Aerobic classes include both high and low impact, step aerobic and aerobic training with weights. Each 50-minute class offers the student a complete body workout. Special senior aerobic classes are offered daily. Membership in the Fitness Center will also include morning and evening use of the free weight area. Certified instructors are available during all hours of operation to help students develop an exercise program to meet their individual needs.

PED115 2 credits 4 periods
Lifetime Fitness
 Fitness activity and wellness study to help develop a lifetime of regular exercise, stress management and proper nutrition. Workout includes warm-up/stretch, aerobic exercise, selected strength exercises, and cool down/stretch. May be repeated for credit. Prerequisites: None.

PED116 2 credits 4 periods
Aerobics for Wellness
 Aerobic activity and wellness study to help develop a lifetime of regular exercise, stress management and proper nutrition. Workout includes warm-up/stretch, aerobic exercise, selected strength exercises, and cool down/stretch. May be repeated for a total of eight (8) credits. Prerequisites: None.

Course Descriptions

PHYSICS

Mathematics/Sciences Division PS 153 (480) 423-6111

PHY101 4 credits 6 periods

Introduction to Physics

A survey of physics emphasizing applications of physics to modern life. Prerequisites: Grade of C or better in MAT090, or MAT091 or MAT092, or MAT093, or satisfactory score on math placement exam. (*PHY101 will satisfy ASU's natural science quantitative requirement (SQ).*)

Engineering majors who have not had a rigorous, quantitative high school physics course, such as Advanced Placement Physics, are advised to take PHY111 as preparation for PHY121 and PHY112 as preparation for PHY131. See the Engineering Science information located in the Program section of this catalog for a suggested 3-year course of study. PHY111 is offered both semesters and usually in the summer. PHY112 is offered in the day and evening in the spring semester, usually in the evening in fall semester, and usually in the day in the summer.

PHY111 4 credits 6 periods

General Physics I

Includes motion, energy, and properties of matter. Recommended for preprofessional and suggested for certain other majors. Prerequisites: Trigonometry or department consent.

PHY112 4 credits 6 periods

General Physics II

Includes electricity, electromagnetism, and modern physics. Prerequisites: PHY105 or PHY111.

PHY121 4 credits 6 periods

University Physics I: Mechanics

Kinematics, Newton's laws, work, energy, momentum, conservation laws, dynamics of particles, solids, fluids, mechanical waves, and sound. Prerequisites: MAT220, or MAT221, or department consent. One year of High School physics or PHY111 and PHY112 is strongly recommended.

PHY131 4 credits 6 periods

University Physics II: Electricity and Magnetism

Electric charge and current, electric and magnetic fields in vacuum and in materials and induction. AC circuits, displacement current and electromagnetic waves. Prerequisites: MAT230 or MAT231 or department consent and PHY121. Corequisites: MAT241 or department consent.

PHY252 4 credits 6 periods

University Physics III: Thermodynamics, Optics, and Wave Phenomena

Heat, entropy, and laws of thermodynamics; wave propagation, geometrical and physical optics; introduction to special relativity. Prerequisites: PHY131.

PHY

PIMA LANGUAGE

Language/Communication Division LC 305 (480) 423-6459

PIM115 3 credits 3 periods

Beginning Pima Conversation I

Conversational Pima. Basic sentence structure, pronunciation, and vocabulary necessary to develop speaking ability in Pima. Designed to develop speaking and listening abilities with little emphasis on grammar. Prerequisites: None.

PIM116 3 credits 3 periods

Beginning Pima Conversation II

Reviews basic Pima vocabulary, pronunciation and sentence structure. Designed to develop speaking, listening, and writing skills in O'odham for effective communication in Pima. Prerequisites: PIM115 or permission of instructor.

POLITICAL SCIENCE

POS

Social/Behavioral Sciences Division SB 130 (480) 423-6206

POS100 3 credits 3 periods

Introduction to Political Science

Introduction to the discipline of political science and its relation to other disciplines with emphasis on the major philosophies and institutions of government. Prerequisites: None.

POS110 3 credits 3 periods

American National Government

Study of the historical backgrounds, governing principles, and institutions of the national government of the United States. Prerequisites: None.

POS115 3 credits 3 periods

Issues in American Politics

Examination of major issues in current affairs in the fields of politics, economics, social relations, foreign affairs, aesthetics, and others through the reading and viewing of secondary information sources. Prerequisites: ENG101 or ENG107 or equivalent.

POS120 3 credits 3 periods

World Politics

Introduction to the principles and issues relating to the study of international relations. Evaluation of the political, economic, national, and transnational rationale for international interactions. Prerequisites: None.

POS135 3 credits 3 periods

Issues in the Arizona State Legislature

An introduction to contemporary political issues faced by the Arizona state legislature. Prerequisites: None.

POS180 3 credits 3 periods

United Nations Studies

Historical origins, structural makeup, political and operational characteristics, and legal activities of the United Nations. Analysis of the overall institution's ongoing utility, productivity and creativity. Prerequisites: None.

Course Descriptions

POS210 3 credits 3 periods
Political Ideologies
Survey of twentieth century nondemocratic ideologies and movements with emphasis on Marx, Lenin, Mussolini, Hitler, Stalin and Mao. Prerequisites: None.

POS221 1 credit 1 period
Arizona Constitution
Examination of the Constitution of the State of Arizona. Equivalent to the second part of POS220. May not enroll in POS220 and POS221 concurrently. Prerequisites: None.

POS222 2 credits 2 periods
United States Constitution
Examination of the United States Constitution. Equivalent to the first part of POS220. May not enroll in POS220 and POS222 concurrently. Prerequisites: None.

PRE-PROFESSIONAL PROGRAMS

Mathematics/Sciences Division PS 153 (480) 423-6111

Scottsdale Community College offers opportunities for students to pursue transfer programs of study in the following preprofessional areas: Pre-Dental, Pre-Forestry, Pre-Medical, Pre-Medical Technology, Pre-Mortuary Science, Pre-Optometry, Pre-Pharmacy, Pre-Physical Therapy and Pre-Veterinary. Although professional schools require substantially the same preparatory program during the first two years of college, significant differences exist; therefore, suggested transfer programs are not included in this section. Students who desire to pursue a preprofessional program of study are urged to establish an early advisement relationship with a member of the science faculty so that a specific program may be planned.

PSYCHOLOGY

Social/Behavioral Sciences Division SB 130 (480) 423-6206

PSY101 3 credits 3 periods
Introduction to Psychology
To acquaint the student with basic principles, methods and fields of psychology such as learning, memory, emotion, perception, physiological, developmental, intelligence, social and abnormal. Prerequisites: None.

PSY132 3 credits 3 periods
Psychology and Culture
Presents current knowledge about human diversity in behavior and culture using examples from a variety of contexts and nations. Highlights topics in cross-cultural psychology, such as intergroup relations, ethnocentrism, gender, personality, emotion, language, communication, work and health. Emphasis on applications of behavioral and cognitive principles to enhance interactions in a multicultural world. Prerequisites: None.

PSY218 3 credits 3 periods
Health Psychology
Behavioral and mental foundations of health, wellness, illness, and disease, and psychological dimensions of medical intervention. Prerequisites: PSY101 with a grade of C or better, or permission of instructor.

PSY225 3 credits 3 periods
Psychology of Religion
Provides an introduction to the history, varieties and theories of the psychology of religion from an empirical, research-based perspective. Specific areas of study include the role of gender, age, socioeconomic status, and personality on religious experience, the effects of religion and prayer on mental and physical health, the development of religious thought and behavior over the lifespan, and the social psychology of new religious movements. In addition, the role of cultural differences on religious attitudes both within the USA and around the world is also addressed. Prerequisites: PSY101 or Permission of Instructor.

PSY230 3 credits 3 periods
Introduction to Statistics
An introduction to basic concepts in descriptive and inferential statistics, with emphasis upon application to psychology. Consideration given to the methods of data collection, sampling techniques, graphing of data and the statistical evaluation of data collected through experimentation. Required of psychology majors. Prerequisites: PSY101 with a grade of C or better and MAT092 or equivalent or permission of instructor.

PSY235 3 credits 3 periods
Psychology of Gender Differences
To assess historical and psychological perspectives on women and men and to evaluate contemporary viewpoints regarding the psychology of women and men. Prerequisites: PSY101 with a grade of C or better or permission of instructor.

PSY240 3 credits 3 periods
Developmental Psychology
Human development from conception through adulthood. Includes: physical, cognitive, emotional and social capacities that develop at various ages. Recommended for students majoring in nursing, education, pre-med and psychology. Prerequisites: PSY101 with a grade of C or better or permission of instructor.

PSY250 3 credits 3 periods
Social Psychology
The scientific study of how people's thoughts, feelings, and behaviors are influenced by other people and situations. Includes how we think about ourselves and others, persuasion and influence, sexual and romantic attraction, friendship and helping others, aggression and prejudice. Prerequisites: PSY101 with a grade of C or better or permission of instructor.

PSY266 3 credits 3 periods
Abnormal Psychology
Distinguishes between normal behavior and psychological disorders. Subjects may include stress disorders, problems with anxiety and depression, unusual and abnormal sexual behavior, schizophrenia and addictive behaviors. Causes and treatments of psychological problems and disorders are discussed. Prerequisites: PSY101 with a grade of C or better or permission of instructor.

Course Descriptions

PSY277 **3 credits** **3 periods**

Psychology of Human Sexuality

Survey of psychological aspects of human sexual behavior. Emphasis placed on the integration of the cognitive, emotional, and behavioral factors in sexual functioning. Prerequisites: PSY101 with a grade of C or better, or permission of instructor. Student must be 18 years or older.

PSY290AB **4 credits** **6 periods**

Research Methods

Planning, execution, analysis, and written reporting of psychological research. Surveys the literature, procedures, and instruments in representative areas of psychological research. Prerequisites: ENG101, ENG107 or equivalent. Prerequisites or Corequisites: PSY230 (or equivalent) with a grade of C or better, or permission of instructor.

READING

RDG

Language/Communication Division LC 305 (480) 423-6459

The reading courses are designed as personal improvement programs for college students. Each student's strengths and weaknesses in study skills, vocabulary, reading rate and comprehension are identified and emphasis is placed on individual improvement.

ALSO SEE: Critical Reading (CRE), page 144

PLEASE NOTE: For Reading English as a Second Language (ESL) courses, see page 162

RDG081 **3 credits** **3 periods**

Reading Improvement

Designed to improve basic reading skills. Includes word recognition, prediction of contents of reading selections, and development of basic vocabulary. Emphasis on identifying main ideas and related details. Reviews following directions and the understanding of graphic materials. Prerequisites: Reading placement test score or permission of instructor.

RDG091 **3 credits** **3 periods**

College Reading Skills I

Designed to improve basic reading and study skills, vocabulary and comprehension skills. Recommended to all students whose placement test scores indicate a need for reading instruction. Prerequisites: Reading placement test score (ASSET), or grade of C or better in RDG081, or permission of instructor.

REAL ESTATE

REA

Business Division Office AP 237A (480) 423-6253

REA179 **3 credits** **3 periods**

Real Estate Principles I

Basics of real estate principles including introduction to the profession and license law, definition of real property, legal descriptions, rights and interests in property, ownership, contracts, real estate economics, financing and foreclosure, land use, and valuation. Prerequisites: None.

REA180 **3 credits** **3 periods**

Real Estate Principles II

Advanced work in real estate including escrow procedures and title insurance, liens and encumbrances, advanced contracts, water rights, toxic waste and environmental hazards, agency, ethics and professional relationships, real estate code and the commissioner's rules, investment, property management, and government restrictions. Prerequisites: REA179 or permission of instructor.

REA283 **3 credits** **3 periods**

Property Management

Emphasizes realty laws, survey of rentals, housing needs, and rents in Phoenix metropolitan area. Prerequisites: REA179 or permission of instructor.

REA284 **3 credits** **3 periods**

Real Estate Appraisal

Includes valuation, market analysis, classification of date and cost factors by emphasizing single family residential properties and income-producing real estate. Prerequisites: REA179 or permission of instructor.

RECREATION (HPERD)

REC

HPERD Division Office PE 149 (480) 423-6606

REC120 **3 credits** **3 periods**

Leisure and the Quality of Life

Overview of the historical, psychological, social and cultural aspects of play, leisure and recreation and their role in contemporary society. Nature of play and leisure behavior in human development within different cultures and the contribution play, recreation and leisure make to the quality of life for individuals in today's society. Prerequisites: None.

REC150AA **1 credit** **2 periods**

Outdoor Adventure Skills Field Experience

Practical application of camping and outdoor skills including camping, equipment selection and use, cooking, fire building, camp programs, backpacking, and safety. Prerequisites: None. *Course Note: Course may be repeated for a total of four (4) credits.*

REC150AB **3 credit** **3 periods**

Outdoor Adventure Skills

Camping and outdoor skills including camping, equipment selection and use, cooking and fire building, camp programs, backpacking, and safety. Prerequisites: None.

REC155AA **1 credit** **2 periods**

Canyoneering

Basic canyoneering skills. Includes hydrology, navigation, safety systems, climbing and hiking skills, wading/swimming techniques and flood/weather identification. Prerequisites: None. *Course Note: May be repeated for a total of four (4) credits.*

REC155AB **1 credit** **2 periods**

Caving

Basic caving skills. Includes cave ecology, navigation, safety systems, lighting systems and equipment selection. Prerequisites: None. *Course Note: May be repeated for a total of four (4) credits.*

Course Descriptions



REC155AC 1 credit 2 periods
Outdoor Rock Climbing
Basic outdoor rock climbing skills. Includes belaying, climbing techniques, rope systems and anchor systems. Prerequisites: None. *Course Note: May be repeated for a total of four (4) credits.*

REC155AD 1 credit 2 periods
Rowing
Basic rowing skills for a four or eight person shell. Includes physical conditioning, rowing etiquette and safety, boat handling, proper rowing techniques, and teamwork. Prerequisites: None. *Course Note: May be repeated for a total of four (4) credits.*

REC155AE 1 credit 2 periods
Indoor Rock Climbing
Basic indoor rock climbing skills. Includes belaying, climbing techniques, rope systems, anchor systems and safety. Prerequisites: None. *Course Note: May be repeated for a total of four (4) credits.*

REC210 3 credits 3 periods
Leisure Delivery Systems
Systemic study of delivery of leisure services in public, commercial and independent sectors; particular emphasis placed on the urban setting. Prerequisites: None.

REC230 3 credits 3 periods
Programming of Recreation Services
Foundations for designing, planning, delivering and managing recreational and leisure events. Emphasis on application of recreation programming concepts and practices in a variety of settings and situations for a diversity of participants. Prerequisites: None.

REC250 3 credits 3 periods
Recreation Leadership
An examination of roles and methods of leadership in leisure services settings. Overview of theories and models of leadership, group dynamics, participant motivation, communication, and face-to-face leadership. Exploration of leadership contexts, including coaching and officiating sports, leading community groups and volunteers, working with persons in various life stages and with varying abilities, and leading different recreation activity areas. Prerequisites: None.

RELIGIOUS STUDIES

REL

Social/Behavioral Sciences Division SB 130 (480) 423-6206

ALSO SEE: Philosophy (PHI), page 194

REL205 3 credits 3 periods
Religion and the Modern World

Introduction to the nature and role of religious beliefs and practices in shaping the lives of individuals and societies, with particular attention to the modern world. Prerequisites: ENG101, or ENG107, or equivalent.

REL270 3 credits 3 periods
Introduction to Christianity

The nature and content of the Christian tradition developed over time, with overview of the New Testament, major historical trends and figures, major Christian ideas and practices, and survey of denominations. Prerequisites: None.

REL271 3 credits 3 periods
Introduction to the New Testament

Origins and development of the literature of early Christian communities; the definition of the New Testament, including its canon, text and translation; the interpretive approaches to the New Testament employed inside and outside Christianity; variety of literature in the New Testament. Prerequisites: None.

SIGN LANGUAGE

SLG

Language/Communication Division LC 305 (480) 423-6459

SLG101 4 credits 4 periods
American Sign Language I

Introduction of principles, methods, and techniques for communicating with deaf people who sign. Development of expressive and receptive sign skills, manual alphabet, numbers, and sign vocabulary. Overview of syntax, grammar, and culture related to American Sign Language (A.S.L.). Prerequisites: None. SLG103 suggested as a corequisite but not required.

SLG102 4 credits 4 periods
American Sign Language II

Continued development of knowledge and language skills for communicating with deaf people who sign. Includes numbers, fingerspelling, and culture. Emphasis on enhancement of receptive sign skills and continued development of expressive sign skills. Application of rudimentary, syntactical, and grammatical structure stressed with continued development of sign vocabulary. Prerequisites: SLG101, with a grade of C or better, or permission of department/division.

SLG201 4 credits 4 periods
American Sign Language III

Linguistics of American Sign Language (A.S.L.) including non-manual behaviors and signing English idioms with conceptual accuracy. Emphasis on practical application of A.S.L. skills, expanded vocabulary, and cross-cultural communication. Prerequisites: SLG102, with a grade of C or better, or permission of department/division. Suggested but not required: (ENG101 or ENG107) and (CRE101 or CRE111 or exemption by score on the reading placement test [ASSET]).

Course Descriptions

SLG202 4 credits 4 periods

American Sign Language IV

Advanced American Sign Language skills including continued vocabulary. Emphasis on conversational techniques in a cross-cultural framework. Continued work on conceptual accurate signing of English idioms and words with multiple meanings. Prerequisites: SLG103, and SLG201, with a grade of C or better, or permission of department/division. Suggested but not required: ENG101, SLG200 and CRE101 or CRE111 or exemption by score on the reading placement test (ASSET).

SMALL BUSINESS MANAGEMENT

SBS

SCC Business Institute

14350 N. 87th Street, Scottsdale (480) 425-6910

www.sccbi.com

SBS200 2 credits 2 periods

Small Business Operations

In-depth analysis of and individual plan development for the "day-to-day" problems encountered in the operation of a small business. Includes the development of an individual business operations plan including finance, purchasing, production scheduling, maintenance, shipping/receiving, personnel management and insurance/risk management requirements. Investigation of daily problems related to inventory control and business expansion. Prerequisites: None.

SBS202 1 credit 1 period

Small Business Bookkeeping and Tax Preparation

Introduces accounting and record-keeping with emphasis on practical use of financial data for the successful management of a small business. Develops an understanding of the accounting cycle and preparation of financial statements. Includes section on tax consequences and preparation for small business owners. Designed for the non-financially oriented owner/manager of a small business. Prerequisites: None.

SBS203 1 credit 1 period

Financing and Cash Management for a Small Business

Planning for and meeting the financial needs of the small business including cash flow planning, identification of financial needs and sources, equity and debt financing, and preparation of loan packages. Participants complete a financial plan for their individual company, with emphasis on cost controls, sales revenue projection, expense allocation, and inventory cost control. Day-to-day operational budgeting also included. Prerequisites: None.

SBS204 2 credits 2 periods

Small Business Marketing and Advertising

Introduction to marketing and advertising strategies and methods including business image, target market analysis, and customer buying behavior profile. Analysis and selection of advertising/business promotion methods and timing. Methods of deciding product and market segment focus included. Design of an individual marketing and advertising/promotion plan. Prerequisite: None.

SBS211 1 credit 1 period

Small Business Computer Applications

Hands-on opportunity for the small business owner to test several current computer application programs. Emphasizes practical applications, hardware and software purchasing decision criteria, and technological developments. Prerequisites: None.

SBS213 1 credit 1 period

Hiring and Managing Employees

Methods and techniques for managing employees in a small business. Includes supervisor's role, leadership styles, interpersonal communications, staff planning, employee work styles, techniques for handling problem employees, and employee motivation. Focuses on real life situations to enable the business owner to gain high performance from their employee team. Includes segment on hiring, new employee orientation, training, benefits, and developing future staffing needs assessment. Prerequisites: None.

SBS214 1 credit 1 period

Small Business Customer Relations

Developing and improving customer relations for the small business. Planning and delivering quality customer service. Includes topics on attitude of employees, customer perceptions and motivations, handling customer dissatisfaction, and developing customer, supplier, vendor, and distributor loyalty. Prerequisite: None.

SBS218 1 credit 1 period

Establishing an Import/Export Business

Basic marketing and management techniques for exporting and importing. Includes researching viability of an import/export business, marketing an export or securing a product for import, and implementing the transaction. Prerequisites: None.

SBS220 2 credits 2 periods

Internet Marketing for Small Business

Focuses on "e-Commerce" - doing business on the Internet and planning a website. Topics include: how the Internet can help growth and success of business; examples of successful marketing on the Internet; availability of Internet services; necessary hardware and software for marketing on the Internet; determining products/services appropriate for Internet marketing; budget constraints and on-going operations of the Internet site. Prerequisites: None.

SOCIETY AND BUSINESS

See SOCIETY AND BUSINESS (SBU), page 131.

Course Descriptions

SOCIOLOGY

Social/Behavioral Sciences Division SB 130 (480) 423-6206

SOC101 **3 credits** **3 periods**

Introduction to Sociology

Fundamental concepts of social organization, culture, socialization, social institutions and social change. Prerequisites: None.

SOC110 **3 credits** **3 periods**

Drugs and Society

Explores drugs as a social problem. Examines social-cultural factors contributing to use and abuse and effects of commonly used drugs on the individual and society. Reviews current theories and research relating to drug use. Explores prevention, intervention, and treatment. Examines public policies concerning drug related issues. Prerequisites: None.

SOC112 **3 credits** **3 periods**

American Indian Policy (AIS112)

Reviews United States government policies and their impact on American Indian sovereignty. Examines historic, legal, economic, and social issues regarding Indian policies and how they impact Indian Nations and individual Indians. Studies historical as well as contemporary policies created by the Federal Government that define the trust relationship between the United States government and Indian Nations. Prerequisites: None.

SOC130 **3 credits** **3 periods**

Human Sexuality

Examination of the physical, social, cultural, and institutional contributions to human sexuality. Examination of facts and myths, literature, and changing mores regarding human sexuality to acquire knowledge about cultural and social events and processes. Explores the sexuality of males and females in contemporary society. Prerequisites: Student must be 18 years or older.

SOC140 **3 credits** **3 periods**

Racial and Ethnic Minorities

Contemporary racial and ethnic intergroup relations emphasizing cultural origins, developments, and problems of minority groups in the United States. Prerequisites: None.

SOC141 **3 credits** **3 periods**

Sovereign Indian Nations (AIS141)

Explores the sovereign status of American Indians as it relates to social relationships, traditions, and culture of American Indians. Reviews historic relations with non-Indian societies, the development of federal Indian law, tribal governments and their functions. Examines treaty rights, environmental issues, public policy, economic development, other current issues, and contemporary social problems. Prerequisites: None.

SOC157 **3 credits** **3 periods**

Sociology of Marriage and Family

The study of courtship, marriage, and family patterns, their historical development, their adaptation to a changing culture, and their impact on individuals. Prerequisites: None.

SOC

SOC160 **3 credits** **3 periods**

American Indian Law (AIS160)

Analyzes the legal system of the United States Government as it applies to American Indian Nations. Examines how United States legal institutions have impacted Indian sovereignty. Units of analysis include the development of Indian law, United States Supreme Court decisions, Congressional Acts, treaty rights and the development of tribal governments. Focuses on legal institutions that have abridged the property rights of Indian Nations. Prerequisites: None.

SOC212 **3 credits** **3 periods**

Gender and Society

A study of the way culture shapes and defines the positions and roles of both men and women in society. Major emphasis on social conditions which may lead to a broadening of gender roles and a reduction of gender-role stereotypes and the implications of these changes. Open to both men and women. Prerequisites: None.

SOC251 **3 credits** **3 periods**

Social Problems

A sociological exploration of selected social problems. Emphasis on current concerns. Prerequisites: SOC101.

SOUTHWEST STUDIES

Southwest Studies Office AD 120 (480) 423-6314
Director, Marshall Trimble

Southwest Studies at Scottsdale Community College is a unique program designed to offer students an opportunity to fulfill part of their general education requirements with a series of classes concentrating on Arizona and the Southwest. The Southwest Studies program offers a variety of courses using an interdisciplinary approach in the humanities, life, physical and social/behavioral sciences, with Arizona and the Southwest as its central theme and brings to students not only the opportunity to expand their knowledge of the area in which they live, but will provide a new sense of relationship to their fellow man.

Southwest Studies Courses

ASB230	Principles of Archaeology
ASB245	Indians of the Southwest
BIO109	Natural History of the Southwest
ENH260	Literature of the Southwest
HIS105	Arizona History
HIS145	History of Mexico

Southwest Studies course descriptions are listed under various prefixes according to the above list.

Course Descriptions

SPANISH LANGUAGE

SPA

Language/Communication Division LC 305 (480) 423-6459

SPA101AA **4 credits** **5 periods**
Elementary Spanish I

Basic grammar, pronunciation and vocabulary of the Spanish language. Includes the study of the Spanish-speaking cultures. Practice of listening, speaking, reading, and writing skills. Prerequisites: None.

SPA102AA **4 credits** **5 periods**
Elementary Spanish II

Continued study of grammar and vocabulary of the Spanish language and study of the Spanish-speaking cultures. Emphasis on speaking, reading, and writing skills. Prerequisites: SPA101 or departmental approval.

SPA115 **3 credits** **3 periods**
Beginning Spanish Conversation I

Conversational Spanish. Basic sentence structure, pronunciation and vocabulary necessary to develop speaking ability in Spanish. Designed for students seeking speaking and listening abilities with little emphasis on grammar. Prerequisites: None.

SPA116 **3 credits** **3 periods**
Beginning Spanish Conversation II

Continued development of speaking and listening skills for effective communication in Spanish. Prerequisites: SPA115 or departmental approval.

SPA201 **4 credits** **4 periods**
Intermediate Spanish I

Continued study of essential Spanish grammar and Spanish-speaking cultures. Continued practice and development of reading, writing, and speaking skills in Spanish. Emphasis on fluency and accuracy in spoken Spanish. Prerequisites: SPA102, or SPA111, or permission of department.

SPA202 **4 credits** **4 periods**
Intermediate Spanish II

Review of grammar, continued development of Spanish language skills with continued study of the Spanish-speaking cultures. Prerequisites: SPA201 or departmental approval.

SPA225 **3 credits** **3 periods**
Intermediate Spanish Conversation I

Continued development of skills in conversational Spanish. A review of the major grammatical and pronunciation problems. Prerequisites: SPA116, or SPA102 or departmental approval.



SPA226 **3 credits** **3 periods**
Intermediate Spanish Conversation II

Continued development of skills in conversational Spanish with a review of grammatical problems. Prerequisites: SPA225, two years Spanish or the equivalent, or departmental approval.

SPA235 **3 credits** **3 periods**
Advanced Spanish Conversation I

Continued development of skills in conversational fluency. Class conducted completely in Spanish. Prerequisites: SPA226 or equivalent, or departmental approval.

SPA236 **3 credits** **3 periods**
Advanced Spanish Conversation II

Further development of skills in conversational fluency. Grammar presented only to clarify student errors. Prerequisites: SPA235 or equivalent, or departmental approval.

SPA265 **3 credits** **3 periods**
Advanced Spanish I

Introduction and study of Spanish and Spanish-American literature. Selected readings from most Spanish-speaking countries. All discussions, oral reports, and written assignments are in Spanish. Prerequisites: SPA202 or departmental approval.

SPA266 **3 credits** **3 periods**
Advanced Spanish II

Further study of Spanish and Spanish-American literature. Reading selections from most Spanish-speaking countries. All oral reports, discussions, and written reports in Spanish. Graduated level of difficulty from the literature studied in SPA265. Prerequisites: SPA265 or departmental approval.

STORYTELLING

STO

Language/Communication Division LC 305 (480) 423-6459

STO292 **3 credits** **3 periods**
The Art of Storytelling (EDU/HUM292)

Explore the art and origin of storytelling. Provide a variety of storytelling techniques, styles and exercises to enhance the delivery of telling stories. Assist in the integration and application of storytelling to the learning environment in the classroom. Prerequisites: None.

SPECIAL PROJECTS

Special projects are available in a variety of disciplines and provides opportunities for individualized learning experiences for students.

XXX298AA	Special Projects	1 credit	1 period
XXX298AB	Special Projects	2 credits	2 periods
XXX298AC	Special Projects	3 credits	3 periods

Organized and tailored around the interests and needs of the individual student. Structured to provide an atmosphere of individualized research and study paralleled by professional expertise and guidance. Professional-type facilities and equipment are made available for student use. Allows the best aspects of independent study and individualized learning to be combined to maximize student development. Prerequisites: None.

Course Descriptions

TELECOMMUNICATIONS

See MOTION PICTURE/TELEVISION PRODUCTION (TCM), page 184.

THEATRE ARTS

Performance Arts Dept. Office PA 133A (480) 423-6356
Fine Arts Division Office MB 139 (480) 423-6328

THE111 3 credits 3 periods

Introduction to Theatre

A survey of theatre, including basic elements and principles of production, styles and/or historical perspectives of theatre, dramatic literature, and criticism. Prerequisites: None.

THE205 3 credits 3 periods

Introduction to Cinema (HUM205)

Survey of the history and development of the art of motion pictures, including criticism of aesthetic and technical elements. Prerequisites: None.

THE210 3 credits 3 periods

Contemporary Cinema (HUM210)

A study of contemporary films, directors and critics with emphasis on evaluating film as an art form. Prerequisites: None.

THE220 3 credits 3 periods

Modern Drama

Analysis of dramatic literature studied within political, historical, and cultural contexts and examined from the perspective of the playwright's structure and style. Prerequisites: ENG101 or ENG107 or equivalent. (Offered in the Spring semester only.)

THEATRE PERFORMANCE AND PRODUCTION

Communication Arts Dept. Office LC 305 (480) 423-6076
Fine Arts Division Office MB 139 (480) 423-6328

THP112 3 credits 4 periods

Acting I

Fundamental techniques and terminology of acting through physical and vocal expression, improvisation, and monologue and scene work. Emphasis on characterization. Prerequisites: None.

THP115 3 credits 4 periods

Theatre Makeup

Purposes, materials, and techniques of theatrical makeup. Prerequisites: None. (THP115 not offered every semester.)

THP120AA 1 credit 2 periods

Audition Techniques: Prepared Monologue

Practice in the techniques of auditioning for the stage. Identifies and illustrates techniques of the prepared monologue audition. Prerequisites: None.

THP120AB 1 credit 2 periods

Audition Techniques: Cold Readings

Practice in the techniques of auditioning for the stage. Identifies and illustrates techniques of the cold reading audition. Prerequisites: None. (THP120AB not offered every semester.)

THP201AA 1 credit 2 periods

Theatre Production I

Designed to give college credit to the cast and technical production crews of college theatre productions. May be repeated for up to a maximum of four (4) credits. Prerequisites: None. (THP201AA not offered every semester.)

THP201AB 2 credits 4 periods

Theatre Production II

Designed to give college credit to the cast and technical production crews of college theatre productions. May be repeated for up to a maximum of four (4) credits. Prerequisites: None. (THP201AB not offered every semester.)

THP210 3 credits 4 periods

Acting: Television and Film

Special technical aspects of acting before a camera. Prerequisites: THP112 or permission of instructor.

THP212 3 credits 4 periods

Acting II

Fundamental techniques of acting through script analysis, rehearsal, and performance. Prerequisites: THP112 or departmental approval.

THP213 3 credits 5 periods

Introduction to Technical Theatre

Procedures of technical theatre production and demonstration. Topics include design and construction of scenery, lighting and properties. Prerequisites: None.

THP214 3 credits 3 periods

Directing Techniques

Contemporary theory and practice in directing, the evolution of present-day directing procedures, and a sampling of scripts for directing practice. Principles of script analysis, blocking, casting, rehearsing and performing. Prerequisites: THP112 and THE220, or permission of instructor. (Offered in the Spring semester only.)

THP216 3 credits 4 periods

Beginning Stage Lighting

Basic theories and methods of stage lighting for all production types. Emphasis on technical/theoretical facts, artistic/design concept development, and teamwork structure of theatre. Examines stage lighting optics, instrument selection and application, color theory, circuiting and control systems, and basic design. Prerequisites: THP213 or permission of instructor. (Offered in the Spring semester only.)

THP220 3 credits 4 periods

Advanced Acting: Television and Film

Focuses on special technical aspects of advanced acting before a camera. Prerequisites: THP210 or permission of instructor.

THP241 3 credits 3 periods

Performance of Literature (COM241)

The study, analysis, and preparation of prose, poetry, and dramatic literature. Preparation of material for public audiences. Prerequisites: ENG101 or ENG107 or equivalent.

Course Descriptions

THP267 3 credits 4 periods

Painting Techniques for Film, TV and Theatre

Theory and skills in scenic artistry. Techniques of painting two-dimensional and three-dimensional scenery, tools, and the use of color. Prerequisites: THP213.

THP270 2 credits 5 periods

Musical Theatre Workshop (MUP270)

Workshop in the study and performance of Musical Theatre repertoire including audition techniques, talent evaluation criticism, rehearsal techniques, vocal acting styles, stage movement, and performance. May be repeated for credit. Prerequisites: None.

THP271 3 credits 3 periods

Voice and Diction (COM271)

Exercises and techniques to free the voice and improve projection, resonance, and articulation. Covers international phonetic alphabet and standard stage speech. Prerequisites: None.

THP281 3 credits 4 periods

Production and Acting I

Provides the continuing acting student with opportunities to expand the versatility of characterization skills. Emphasis on relating the actor's work to the total production process. Performance of monologues, scenes, and one-act plays. Prerequisites: Departmental approval.

THP282 3 credits 4 periods

Production and Acting II

Provides the continuing acting student with opportunities to expand the versatility of characterization skills. Emphasis on relating the actor's work to the total production process. Performance of monologues, scenes, and one-act plays. Prerequisites: THP281 or departmental approval.

THP298 - SPECIAL PROJECTS: Information about THP298 courses can be found on page 203.

Southwest Shakespeare Conservatory Theatre

SCCT Hotline (480) 423-6718

THP291AA 1 credit 2 periods

Summer Conservatory: Stage Movement

Techniques of body centering, coordination, relaxation, energization, and physical expression for the actor. May be repeated for a total of three (3) credit hours. Prerequisites: By audition and interview only.

THP291AB 1 credit 2 periods

Summer Conservatory: Voice and Diction

Basic principles and techniques of voice production and stage speech for the actor. May be repeated for a total of three (3) credit hours. Prerequisites: By audition and interview only.

THP291AC 1 credit 1 period

Summer Conservatory: Script Analysis (ACT)

Theory and practice in analysis of dramatic literature for the actor. Emphasis on techniques of character analysis for interpretation. May be repeated for a total of three (3) credit hours. Prerequisites: By audition and interview only.



THP291AD 1 credit 2 periods

Summer Conservatory: Improvisation

Techniques of improvisation to develop the actor's creativity. Emphasis on inner resources, sensory memory, and emotional memory. May be repeated for a total of three (3) credit hours. Prerequisites: By audition and interview only.

THP291AE 3 credits 4 periods

Summer Conservatory: Scene Study

Basic methodology and process of rehearsing and creating a character through prepared scenes for faculty critique and analysis. May be repeated for a total of nine (9) credit hours. Prerequisites: By audition and interview only.

THP291AF 1 credit 2 periods

Summer Conservatory: Career Development (ACT)

Principles of the business of being an actor. Emphasis on audition techniques. May be repeated for a total of three (3) credit hours. Prerequisites: By audition and interview only.

THP291AG 4 credits 5 periods

Summer Conservatory: Production (ACT)

Practicum in rehearsal and stage performance through public productions. May be repeated for a total of twelve (12) credit hours. Prerequisites: By audition and interview only.

Course Descriptions

TRANSLATION AND INTERPRETATION

TRS

Language/Communication Division LC 305 (480) 423-6459

TRS100 4 credits 4 periods

Survey of Translation and Interpretation

Professional, sociolinguistic, and cognitive aspects of translation and interpretation. Includes social justice goals and language policy for interpretation and translation, role of translators and interpreters, consecutive interpretation, role of norms in legal translation, conservation of meaning, register, and style, meaning of translation, health care interpretation and translation, business and technical translation. Prerequisites: None.

WELLNESS EDUCATION

WED

HPERD Division Office PE 149 (480) 423-6606

WED151 3 credits 3 periods

Introduction to Alternative Medicine

Definition of health; exploration of mind-body-spirit connection in health; various therapeutic modalities; identification of strengths and limitations of alternative therapies. Also includes development of ability to critically review written material in the alternative therapy area. Prerequisites: None.

WED162 1 credit 1 period

Meditation and Wellness

Physiology of meditation and its effects on physical and mental health; scholastic abilities and interpersonal relationships; differentiation between meditation and other relaxation techniques. Prerequisites: None.

WED165 2 credits 2 periods

Overview of Massage Therapy

History of massage; overview of bodywork systems; benefits and indications of massage; legal requirements for practice in Arizona. Prerequisites: None.

WED172 1 credit 1 period

Overview of Herbal Remedies

History and evolution of herbs for healing applications. Preparation, usage, and effects of certain herbs used for healing purposes. Basic literature review skills in the area of herbal medicine. Prerequisites: None.

WED195AA-AC 0.5-2 credits 1-2 periods

Special Topics in Wellness Education

Introduction to current topics and contemporary issues related to developing and maintaining a healthy lifestyle. Focuses on a variety of techniques and strategies to promote wellness. Prerequisites: None.

WED218 1 credit 1 period

Aromatherapy

Physiology of aromatherapy; methods of use; preparation of oils; uses in sports, beauty care, massage, child care, health care, at work, and in the home. Prerequisites: None.

WED242 1 credit 1 period

Therapeutic Touch: Level II (CAT242)

Experience in specific Therapeutic Touch (TT) exercises and practice at the intermediate level. Includes healing processes for the client and practitioner. Prerequisites: WED/CAT142 and current TT practice.

WOMEN'S STUDIES

WST

Language/Communication Division LC 305 (480) 423-6459

WST209 3 credits 3 periods

Women and Films (HUM209)

Analysis of images of women in films from both historical and contemporary perspectives. Prerequisites: None.

WST285 3 credits 3 periods

Contemporary Women Writers (ENH285)

Explores twentieth century literature (short stories, essays, plays, and poetry) written by women and about women. Focus on themes relevant to women's lives regardless of age, creed, or ethnic background. Prerequisites: None.



STUDENT SERVICES

Admissions and Records Office

☎ 80) 423-6100

The SCC Admissions and Records Office is located in the Student Services Building. This office provides information and services concerning the following:

- Athletic Eligibility
- Class Schedules and Catalogs
- Grades/Grade Corrections
- Graduation
- Name/Address Change
- Registration
- Schedule Changes
- Student ID Correction
- Transcripts
- Tuition and Fees Information
- Verification Letters
- Withdrawal

Photo ID is required for all transactions.

See Maricopa Online Student System, page 210, for information on how to access many of these services.

The Admissions and Records Office is open Monday through Thursday from 8:00 a.m. to 7:00 p.m.; Friday from 8:00 a.m. to 5:00 p.m.; summer hours are Monday through Thursday from 8:00 a.m. to 7:00 p.m.

Adult Re-Entry Services

☎ 80) 423-6562

Re-Entry Services develops and coordinates a system of counseling and support services for adult students who are seeking a new future by returning to their educational goals at Scottsdale Community College. Specifically, the program supports adult success with these services and programs:

- Re-Entry Advisement/Counseling
- Academic Survival Skills Workshops
- Math Tutoring
- Personal Development Programs
- Research Related to Lifelong Learning

The department also advises A.W.A.R.E. (Adults Who Are Returning to Education), a student organization dedicated to supporting other returning adults. Together with other projects, the organization assists with:

- Adult Re-Entry Student Orientation
- Scholarship Fund-raising
- Women's History Month Luncheon

Students may make individual appointments or register for lectures and workshops by visiting the Adult Re-Entry Office in the Student Center Building, Room 134, or by calling (480) 423-6562.

Advisement Center

☎ 80) 423-6539

The mission of the Advisement Center is to assist students in the creation of education plans to achieve their academic, career and life goals. We promote a proactive approach that engages students in their development and success.

The Advisement Center provides academic information and advisement for all students. Assistance is available to aid the student in defining academic goals, choosing an educational program, selecting appropriate courses, learning about majors and degrees, exploring career possibilities and transferring to other colleges.

Advising offers students an opportunity to meet one-on-one with a concerned faculty or staff member to make decisions about college and to receive referrals to a wide variety of campus resources.

Students are strongly encouraged to seek advisement prior to registering for each semester. To prepare for advisement, students should gather their transcripts, placement test scores and any other information that might be relevant to their educational planning.

The Advisement Center is open Monday through Thursday from 8:00 a.m. to 7:00 p.m. and Friday from 8:00 a.m. to 5:00 p.m. Appointments are needed on Tuesday, Wednesday and Thursday between 8:00 a.m. and 4:00 p.m. Students should call ahead for an appointment. During summer hours the Center is closed on Friday.

American Indian Program

☎ 80) 423-6531

The American Indian Program Office provides assistance to American Indian students enrolled at Scottsdale Community College through three program components which include Support Services, Curriculum Development and Indian Community Outreach.

Students can obtain special services such as college counseling, academic advisement, financial aid advisement and general assistance through the Support Services component. The Curriculum component provides the American Indian Program and Instructional Divisions the opportunity to develop transferable courses in American Indian Studies, Tribal Development and programs responsive to tribal education needs. The American Indian Program Office also provides academic outreach services to surrounding Indian communities. The American Indian Program sponsors the Sun Earth Alliance Indian Club and the American Indian Honor Society.

The American Indian Program Office is located in the Student Center, Rooms 135 and 140, and is open Monday through Thursday from 8:00 a.m. to 7:00 p.m. and Friday from 8:00 a.m. to 5:00 p.m.; summer hours are Monday through Thursday from 8:00 a.m. to 7:00 p.m.

Bursar/Cashier's Office

☎ 80) 423-6148

The services performed by the Bursar/Cashier's Office are as follows:

Collection

Payments for tuition, fees, debts and college activities.

Disbursement

Financial aid monies, honors awards, fee waivers, refunds, paychecks and scholarships.

Cashing Checks

Personal checks only with a \$10.00 limit. A \$15.00 fee is assessed on checks returned by the bank for any reason.

The following information will provide the student with efficient service while conducting business at the Bursar/Cashier's Office:

1. A picture ID is required for all transactions.
2. Fees paid by credit card will be refunded to the charging credit card, with no exceptions.
3. Only the student whose name is on a financial aid check or refund check may pick up the check.
4. The student's Student Identification Number must appear on the front of any check presented for a payment or cash.

The Bursar/Cashier's Office is open Monday through Thursday from 8:00 a.m. to 7:00 p.m.; Friday 8:00 a.m. to 5:00 p.m.; summer hours are Monday through Thursday from 7:00 a.m. to 7:00 p.m.

Bus Service

Students and visitors requiring public transportation to the campus can call (602) 253-5000 for current information on bus arrival and departure times. Students may purchase monthly or semester bus passes at the SCC Bookstore. Information on bus service is also available at the following website: www.valleymetro.org.

Student Services

Career & Cooperative Education Services

☎ 80) 423-6523

Career Services

The mission of Career Services is to provide career advising for students to assist them in making informed decisions in selecting career goals and educational plans. Students and community members seeking employment opportunities are given guidance and information to facilitate job searches in an ever changing world of work.

Career & Cooperative Education Services offers resources and personal assistance with career decision-making, career planning, educational major selection, job seeking, résumé writing and interviewing skills. Assistance with Cooperative Education is also available. For more detailed information about this program, please see Cooperative Education on page 142. The latest computer resources are also available to aid in these processes. Employers recruit throughout the year in the career center, and job fairs are sponsored annually for SCC students and the community. For additional information check out the website at www.scottsdalecc.edu/career.

The Career and Cooperative Education Services office is located in the Student Center, Room SC-123, and is open Monday through Thursday from 8:00 a.m. to 7:00 p.m.; Friday from 8:00 a.m. to 5:00 p.m. Summer hours are Monday through Thursday from 8:00 a.m. to 7:00 p.m.

Visit www.collegecentral.com/scottsdale for area listings of full-time and part-time jobs or stop by the center for personalized assistance.

Child Enrichment Center

☎ 80) 423-6429

Our mission at the SCC Child Enrichment Center is to provide a diverse developmental experience in a nurturing environment to the children of SCC parents and serving as a resource to SCC and the community.

Affordable quality child care services are available to children of SCC students. Children two through five years of age are eligible to attend the Child Enrichment Center. The on-campus center is staffed by trained Early Childhood Teachers. The program is designed to facilitate social/emotional growth, physical and cognitive development in a play environment. The center is accredited by the National Academy of Early Childhood Programs.

Morning, afternoon and full-day sessions are available. Children must be pre-enrolled to attend. To enroll, SCC students will need to come to the center and obtain an enrollment packet. All enrollment requirements must be completed before a child may attend the program. Please call the Child Enrichment Center for more information.

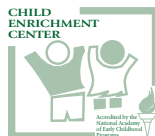

Clubs/Organizations for Students

☎ 80) 423-6538

Participation in the work of various clubs and organizations on campus provides students an opportunity to acquire leadership, planning and social skills that are important for successful living.

The Student Life and Leadership Office maintains a list of active clubs and organizations. Or, you can stop by to find out how to start an organization of your very own!

SCC Clubs/Organizations

Advocacy@SCC	Hillel (Jewish Community Club)
Airsoft/Paintball Club	Hospitality, Sales & Marketing Assoc.
American Indian Honors Society	Imagemakers
AWARE (returning adult students)	International Community Club
Black Student Union	MESH (Math/Engineering/Science/Health)

Campus Crusade for Christ	Outdoor Adventure Club
College Democrats	Phi Theta Kappa
College Republicans	Psi Beta (psychology)
Criminal Justice	Rotaract (business and community service)
Dance Club	SCC ASID (interior design)
Fencing Club	SCC Student Nurse Association
Focal Point	Sports Medicine Club
Friends of Kids	Student Leadership Forum
Gay-Straight Alliance	Sun Earth Alliance Indian Club

Counseling Services

The mission of Counseling Services is to support learning and retention by assisting students with identifying and achieving their diverse personal, educational, and career goals. Our mission is achieved through individual and group counseling, instruction, and crisis intervention, in addition to consultation and training with faculty and staff. The Counseling Office is located in the Student Center, Room 108, and is open Monday through Thursday from 8:00 a.m. to 7:30 p.m.; Friday from 8:00 a.m. to 4:00 p.m.; summer hours are Monday through Thursday from 8:00 a.m. to 6:30 p.m. Services provided by the counseling faculty and staff include:

Educational Planning

To aid in selecting an educational program, in deciding courses at SCC, transferring to other colleges, improving study skills, and referral to tutorial or remedial assistance.

Career Counseling

To assist in exploring possible vocational directions and learning about the student's relation to the world of work.

Personal Counseling

To help examine personal concerns which may interfere with a student's academic progress/success.

Testing

To provide standardized testing as needed for the counselor to assist a student in decision making for areas such as college major and/or career selection.

Referral

To provide information and referral to campus resources, or for ongoing assistance with personal concerns and/or psychotherapy treatment options, referral to outside agencies.

Consultation

To assure student success and foster a positive learning environment by working with the faculty and staff.

Workshops and Seminars

Periodically, workshops are offered for students, faculty and the campus community. Topics may include: self-esteem building, reducing test anxiety, stress management, divorce, self-assessment for careers, re-careering, substance abuse, relationship building, learning style strategies and others.

Credit Courses

Personal growth and development courses are offered each semester by counseling staff. They range from personal assessment to skill development and may be offered for one to three credits. See the class schedule for a list of courses offered in the Counseling and Personal Development, CPD, prefix.

Student Services

Culinary Arts Dining Room

☎ 80) 423-6284

The Culinary Arts Department operates student-run dining facilities for both lunch and dinner during the fall and spring semesters. Located in the Applied Sciences Building in the northeast area of campus, the Artichoke Grill features an *à la carte* luncheon menu Tuesday through Friday from 11:30 a.m. to 1:00 p.m. with prices from \$2.25 to \$7.95. The Desert Oasis is open Wednesday through Friday from 6:00 p.m. to 8:00 p.m. and serves complete five-course meals for \$18.50 plus beverage and tax.

Our menus, which change weekly, feature American Regional culinary creations. The menus for each week can be seen at our web site, www.scottsdalecc.edu/culinary. Both The Artichoke Grill and The Desert Oasis are available for individual dining as well as private group functions. Reservations are recommended.

Disability Resources and Services

☎ 80) 423-6517

Disability Resources and Services (DRS) provides information and services to students with any documented disability, who are attending classes at Scottsdale Community College. Disability Resources and Services strives to empower students, foster independence, and promote achievement of realistic career and educational goals.

Students who wish to receive academic accommodations are required to contact the DRS office and follow an intake eligibility process prior to receiving accommodations. Appropriate documentation must be presented to DRS verifying the existence of a disability as defined under Section 504 of the Federal Rehabilitation Act of 1973, and under the Americans with Disabilities Act of 1990; and establishing a clear connection between the accommodations being requested and the effects of the disability. The DRS office, along with the campus community, will assist students to discover, develop, and demonstrate their full potential and abilities.

DRS is located in the Student Center Building, Room 144. Call (Voice) 480-423-6517 or (TTY) 480-423-6566 for more information. Office hours are Monday through Thursday from 8:00 a.m. to 7:00 p.m.; Friday from 8:00 a.m. to 5:00 p.m. Summer hours are Monday through Thursday from 8:00 a.m. to 7:00 p.m.; closed Friday.

Facility Requests

☎ 80) 423-6506

The Facilities Office is responsible for processing Facility Request Forms and coordinating the use of campus facilities that include: the Student Center Building, outdoor campus space and some meeting rooms.

Any student club or organization wishing to schedule a meeting, event or fundraiser on the SCC campus must begin by completing the Facility Request Form and submitting it to the Facilities Office. A Fundraising form must accompany the Facility Request Form for events that will be raising money for a specific cause (see Fundraising Policy, page 214). Contact the Facilities Office at (480) 423-6506 for more information.

Financial Aid

☎ 80) 423-6549

The student financial aid program is designed to provide assistance to students from federal, state, institutional, and private funding sources. The program also provides information about sources of funding and application procedures to assist students and their families in meeting college expenses.

Student financial aid may be provided in the form of grants, scholarships, employment, and loans. The Financial Aid Office can provide complete scholarship and financial aid information, or information can be accessed online at: www.scottsdalecc.edu/financial.

Financial aid applications are required to be submitted annually. The Free Application for Federal Student Aid covers the school year which includes the Fall Semester, Spring Semester, and both Summer Sessions. The priority deadline is June 1 prior to the start of the Fall Semester in August, November 1 prior to the start of the Spring Semester in January, and May 1 prior to the start of both Summer I and II sessions in June. Applications received after these dates will still be considered for aid, but funds may not actually be received until after the start of the semester.

Applications are available in the Financial Aid Office, located in the Student Center Building, Room SC152, and also online at www.scottsdalecc.edu/financial. The Financial Aid Office is open Monday through Thursday from 8:00 a.m. to 7:00 p.m.; Friday from 8:00 a.m. to 5:00 p.m.; summer hours are Monday through Thursday from 8:00 a.m. to 7:00 p.m.

Food Services

☎ 80) 423-6280

The SCC Cafeteria is located in the north side of the Student Center Building. A satellite snack bar is located on the east side of campus, north of the Business Building. SCC Food Services is operated by the Maricopa Community College District.

The Cafeteria is open from 7:00 a.m. to 9:00 p.m. Monday through Thursday and 7:00 a.m. to 2:00 p.m. on Friday. A variety of ethnic foods and home-style cooking is available on rotating menus and daily specials. A full-service deli and grill are open for breakfast and lunch. Quick pick items as well as a full line of beverage and candy items are available. Catering services are offered at reasonable prices. Contact SCC Food Services for quotes.

Vending Machines

Vending machines are available throughout the campus to provide soft drinks, snacks and candy. If money is lost in any of the machines, contact the Food Service Manager in the cafeteria.

Honors Program

☎ 80) 423-6525

The SCC Honors Program promotes academic excellence and offers scholarship opportunities. The program is for students who enjoy intellectual challenge, lively discussions and small classes with enthusiastic instructors.

Students are challenged to:

- participate in shared learning;
- discuss ideas rationally and logically;
- express thoughts clearly; and
- relate national and international issues with those being discussed in class.

Information about Honors classes and the Honors Program application can be found outside the Honors Office, located in the Library Building, Room LB105F. Call for office hours or consult with an academic advisor in the Advisement Center (480) 423-6539.

Housing

☎ 80) 423-6538

Scottsdale Community College has no residence halls. Out-of-town students will need to make their own arrangements for housing in one of the nearby cities where ample rental units are available. Questions regarding housing may be directed to the Student Life and Leadership Office.

Student Services

International Education Programs

☎ 80) 423-6590

The International Education Programs (IEP) department believes in creating a campus environment which encourages and develops intercultural awareness and promotes a global perspective through an open exchange of ideas. This is accomplished by providing quality international student services, promoting study abroad opportunities, sponsoring numerous cultural events, and supporting professional development programs for today's changing and multicultural world.

The IEP Office is located in the Student Center Building and is open Monday through Thursday from 8:00 a.m. to 7:00 p.m. and Friday 8:00 a.m. to 5:00 p.m.; summer hours are Monday through Thursday from 8:00 a.m. to 7:00 p.m.

Library Services

☎ 80) 423-6651

The SCC Library is the focal point for information services on the SCC campus. The collection includes books, periodicals, reference works, online databases, microforms, maps, music and sound recordings, and videos to support campus instruction. The Library strives to facilitate quality library instruction and service focusing on student success, information literacy, and teaching and learning excellence.

The SCC Library's web site (www.scottsdalecc.edu/library) provides access to several resources, including the online catalog which contains the holdings in all of the Maricopa Community College Libraries. There is a large selection of commercial databases of magazine and journals, and newspaper articles. Many articles are available full-text and can be printed, saved to disk, or e-mailed. Students may access all library databases from off-campus.

To obtain an SCC Library card, you must show a photo ID with a current address; or students may use an SCC student ID or a Fitness Center ID to check-out library materials. The loan period for most materials is three weeks. A fine of 10 cents per day is charged for each overdue item. Fines accrue at 50 cents per hour for reserve materials and limited loan items.

Photocopiers and microfilm copiers are available. Study rooms can be reserved in advance for individual or group study.

Library hours are Monday through Thursday from 7:30 a.m. - 9:30 p.m.; Friday, 7:30 a.m. - 4:00 p.m.; Saturday, 10:00 a.m. - 2:00 p.m.; and closed on Sunday. Call or check the web site for holiday, intersession, and summer hours.

Mailboxes

Clubs and Organizations

Recognized campus clubs and organizations have mailboxes in the Student Life and Leadership Office in the Student Center Building, Room 185. Communications to clubs/organizations may be distributed by placing materials in the designated mailbox.

Faculty and Staff

Faculty and support staff mailboxes are located in the copy center in the southwest corner of the library building in Room LB127B. Material to be mailed or distributed may be left with a copy center team member, or in the basket at the window. Bins for intercampus mail, outgoing mail and district mail are located inside the center to the far right of the entrance. Individual stamps for personal mail may also be purchased on a convenience basis. To contact the copy and mail center, please dial (480) 423-6645 during regular hours of 6:30 a.m. until 7:30 p.m., Monday through Thursday, and until 5:00 p.m. on Fridays.

Maricopa Online Student System

Through SCC's web site (www.scottsdalecc.edu), students can access the following features:

- Apply for admissions
- Register for courses
- Add/drop courses
- Check class schedule
- Check fee balance and pay fees
- Address verification/correction
- Check course availability
- Request official transcripts
- View unofficial transcript
- Check holds
- PIN maintenance
- Check student grades
- Auto emissions requirements

The Maricopa Online Student System URL is:

<https://tnapp1.dist.maricopa.edu/>

Meeting and Conference Rooms

☎ 80) 423-6506

Scheduling meeting and conference rooms for SCC campus activities is processed by the Facilities Office. A Facilities Request Form, available at the office, must be completed at least two weeks prior to the event. Contact the Facilities Office at (480) 423-6506 for more information.

All facility requests from student organizations must have the signature of the organization's advisor. If the event is a fundraiser, the Facility Request Form must be accompanied by the Fundraising Request Form with all of the appropriate signatures (see Fundraising Policy, page 214, for more information). Fees may apply.

Men's Athletics

Scottsdale Community College is a member of the National Junior College Athletic Association. Men may participate in basketball, tennis, track, cross-country, golf, baseball, soccer and football. SCC men's teams have competed in national tournaments in baseball, basketball, golf, tennis and track. Please contact the Athletic Department at (480) 423-6285 for more information.

Open Computer Lab

The Open Computer Lab provides computer hardware, software and technical support for all currently enrolled students. We have over 70 computers (including four Macs), as well as CD burners, printers, and a scanner. The helpful and friendly lab staff will be happy to help answer your computer-related questions or problems. The Open Computer Lab is located on the east side of campus in BU133. Normal hours of operation are Monday - Thursday from 7 a.m. to 10 p.m., Fridays from 7 a.m. to 4 p.m., and Saturdays from 8 a.m. to 4 p.m. Hours vary during the summer and during intersessions.

Orientation and Campus Tours

The Student Life and Leadership Office is responsible for the SCC Student Orientation Programs, which are held in August and January prior to the start of classes. SCC Campus tours are arranged by contacting the office, located in the Student Center Building, Room 185, or calling (480) 423-6538.

Psi Gamma Chapter of Phi Theta Kappa

Psi Gamma is the Scottsdale Community College chapter of Phi Theta Kappa, the honor society for two-year colleges. Phi Theta Kappa offers an exhilarating and inspiring atmosphere for educational enhancement. Active membership stimulates personal growth, provokes the mind and sets a standard for the student's future. Every other year Phi Theta Kappa selects a new study topic and expects its members to participate in related activities and explore them in depth.

Student Services

An invitation to join is extended to currently enrolled students who have accumulated at least 12 credit hours of 100 or above level classes and have attained a grade point average of 3.5 or higher.

The standards of Phi Theta Kappa are set forth in the four hallmarks: scholarship, leadership, service and fellowship. Psi Gamma is pleased that its efforts in the four hallmarks have resulted in recognition at the 1999 International Convention as one of the top chapters in the country.

Psi Gamma is active on the campus, in the community, in the Arizona region and at the International levels. Activities include conducting meetings twice a month, participating in the Honors Forum as well as community service projects, blood drives and bone marrow testing. Psi Gamma members attend regional camping trips, leadership and regional conventions, the Honors Institutes and International Convention. There is something interesting for everyone, but most rewarding is the friendship that will be developed with other students. Contact the Student Life & Leadership office at (480) 423-6794 for more information.

Senior Adult Education Program

☎ 80) 423-6560

The Senior Adult Education Program at SCC is committed to excellence in education for mature adults. The program encourages retirees and younger students alike to regard learning as a lifelong process with continuing rewards. This intergenerational program is open to people of all ages.

The Senior Adult Education Program offers a variety of credit and noncredit courses, a free lecture and travel series, workshops and other activities, including the new SCC Silver Striders Walking Club.

The expertise of retired persons is utilized along with that of SCC faculty and staff in lecturing and in teaching noncredit courses, sharing travel slides, serving on committees and in other ways.

The program attempts to accommodate the needs and interests of busy senior adult learners by offering short-term courses and activities, mostly in the afternoons.

An advisory committee composed of retired persons representing various senior adult organizations, older adults, faculty and staff offers guidance to the program.

Through the Senior Adult Writing Project, seniors are encouraged to share their creative talent, broad experience and historical perspective in collected anthologies of their writings.

The program office is located on the west side of the Library Building, LB 106C, and is open from mid-August through mid-May; Monday through Friday 8:00 a.m. to 5:00 p.m. For more information, call (480) 423-6560.

Student Accident Insurance

Each student is covered by a student accident insurance policy paid for by student activity fees. This policy provides for medical care and treatment in case of accident while on campus, while participating in athletic events, while riding in college vehicles en route to participate in intercollegiate competition or while participating in any college-sponsored event, either on or off campus.

For information on student accident insurance plans, and/or student accident and sickness plans beyond the above-mentioned circumstances, please visit the Student Life & Leadership Office in SC-185.

Student Life & Leadership Programs & Services

www.scottsdalecc.edu/lsf
☎ 80) 423-6538

The mission of Student Life and Leadership is to foster a connective spirit of cooperation where students are able to:

- Develop as moral and ethical leaders in a multicultural society.
- Find a meaningful sense of community, civility and citizenship.

- Identify and appreciate human differences through a diverse offering of experiential learning activities, special projects and supportive services.

To get the most out of their time in college, all students are encouraged to participate in programs and special projects sponsored by the Student Life & Leadership office. Research shows students involved outside of their classrooms are more likely to graduate, more likely to graduate on time and more likely to enjoy their educations. Plus, such involvement can help students make sense of and enhance their academic coursework, and help them when looking for jobs, applying for scholarships and/or transferring to other institutions.

Some of the programs and special events in which a student can participate with the Student Life & Leadership Office include: New Student Orientation (Fall and Spring), college-wide festivals, community service experiences, cultural celebrations, student government, student clubs and organizations, student leadership development and college commencement. The programs and special events for this year are listed on page 213.

Many services are also available through the Student Life & Leadership Office to assist students in finding success while at SCC. These include student ID cards, campus tours, loan programs, policy dissemination, posting approval, voter registration and calculator rentals.

This is truly the office helping students make things happen !

Student Leadership Forum

☎ 80) 423-6541

The Student Leadership Forum (SLF) serves as a foundation for unity, as well as a sense of community, among students and student groups at SCC. As the official voice of students, SLF includes eight Executive Officers, 12 Students-at-Large and numerous Club Representatives. Recruitment occurs at the end of the Spring term and the start of the Fall term; interested students should stop by the Student Life & Leadership office, SC-185, to pick up an application, or call (480) 423-6541.

As a student member of SLF, students learn valuable leadership skills, plan special projects, and serve as a representative of and to the SCC campus. They meet new people and gain new experiences. They work on committees and volunteer in our community. They not only change the lives of others but also their own. Most importantly, they do all this and more, and HAVE FUN doing it!

Testing Center

www.scottsdalecc.edu/testingcenter
☎ 80) 423-6433

The mission of Testing Services at Scottsdale Community College is to provide a quality environment where students are encouraged to achieve to the best of their abilities, facilitate accurate course placement and to assure that the highest level of testing standards are maintained.

Located in the Library Building, Room LB 165, the Testing Center is an integral part of services provided to incoming and enrolled students at Scottsdale Community College. Students come to the Testing Center for course placement (ASSET/COMPASS), English as a Second Language course placement (CELSA), and course makeup exams. While there is no charge for taking these tests, students must present photo identification when they arrive. New students must also submit a completed Student Information Form to the Admissions and Records Office prior to taking course placement tests.

The three-test battery for English, Reading and Math placement is given Monday through Thursday from 8:15 a.m. to 5:00 p.m.; *Friday from 8:15 a.m. to 3:00 p.m. Single placement tests are given Monday through Thursday from 8:15 a.m. to 5:30 p.m.; *Friday from 8:15 a.m. to 3:30 p.m. Students who are taking the test for Financial Aid purposes must complete all three tests during one test session. The use of calculators is permitted on algebra tests but not required. Results are provided after testing is completed.

Continued next page...

Student Services

Other tests and services, such as the Nursing Entrance Test, HCC Credit by Exam and proctoring for distance learning classes are also available. Fees are applicable for these services; please contact the Testing Center for more information.

The Testing Center is open Monday through Thursday from 8:00 a.m. to 7:00 p.m.; *Friday from 8:00 a.m. to 5:00 p.m. All testing is not available during all office hours.

*The Testing Center is closed on Fridays June through mid-August.

Tutoring Services

Math/Science Center (480-423-6145)

The Math/Science Center is located in the Computer Science/Mathematics Building, Room 441A. What does it offer?

- Walk-in tutoring for math, physics, biology, chemistry (no appointment necessary)
- Individual or group study available
- Math and science faculty available to help students
- Videos of arithmetic lessons
- Computer and software use for special projects or extra drills.

The Math/Science Center is open Monday through Thursday from 8:00 a.m. to 7:30 p.m.; Friday from 8:00 a.m. to 2:00 p.m.; Saturday from 10:00 a.m. to 2:00 p.m.; summer hours are Monday through Thursday from 8:00 a.m. to 2:00 p.m. and 5:00 p.m. to 7:00 p.m. (evening hours June and July only).

Independent Study Lab (480-423-6223)

The primary focus of the Social/Behavioral Sciences' Independent Study Lab is to help students develop the skills to become independent, effective and efficient learners. Tutoring is offered in anthropology, early childhood development, economics, geography, history, philosophy, political science, psychology and sociology.

The following services are free to all SCC students:

- Individual or group study and tutoring;
- Assistance with preparation of class materials;
- Curriculum tutorials available on computer, compact disk, video cassette and printed materials;
- Computers (Macintosh or IBM) and VCRs available; and
- Internet access.

The Independent Study Lab is located off the center hall in the Social/Behavioral Science Building, Room 158. Hours are Monday through Thursday from 7:30 a.m. to 8:00 p.m.; Friday from 7:30 a.m. to 3:00 p.m.; summer hours are Monday through Thursday, 7:00 a.m. to 8:00 p.m.; closed on Friday during the summer.

The Writing Center (480-423-6416)

The Writing Center's services are free to all currently enrolled SCC students and include the following:

Tutoring:

- English and ESL tutors to assist students with all SCC writing assignments (not just those assigned in English classes)
- Foreign language tutors to help students develop grammar, pronunciation, and conversation skills

Computing:

- Word processing (both IBM and Macintosh)
- Internet access
- English grammar drills
- ESL and foreign language grammar and pronunciation drills

Other Services:

- Makeup viewing of videos for Language and Communication classes
- Reference materials for help with research papers and other writing assignments

The Writing Center is located in the Language and Communication Building, Room 379. During the fall and spring semesters, the Center is open for computer use Monday through Thursday from 7:30 a.m. to 8:30 p.m. and Friday 7:30 a.m. to 3:00 p.m. Summer hours are Monday through Thursday from 7:00 a.m. to 8:00 p.m.

A student may receive tutoring for the SCC class or classes in which he/she is currently enrolled. A student may not receive tutoring for any class taken at another college or university regardless of concurrent enrollment at SCC. Students are strongly encouraged to schedule tutoring appointments in advance. For information about English, ESL, and foreign language tutoring hours, please call the Writing Center at the number listed above.

Veterans Services

☎ 80) 423-6515

Scottsdale Community College strongly supports Veterans Services on the campus. As a Veteran you are invited to avail yourself of these services as the first step in achieving your college objectives. The Veterans Office provides the appropriate certification and referrals for all necessary SCC and community services. Veterans are provided an essential line of communication for Department of Veterans Affairs/Veterans Administration inquiries, educational benefit information, pertinent legislative news and the necessary advising to ensure a smooth transition to the college environment for all veterans and dependents.

RECIPIENTS SHOULD NOTE: "Campus Policy and VA Compliance Regulations" will differ regarding Academic Standards, Enrollment Restrictions, Residency Status, etc.

All G. I. Bill Educational Benefits recipients must report to the Veterans Office, located in Admissions and Records in the Student Services Building, on a semester basis for V.A. benefit certification. The office is open Monday through Thursday from 8:00 a.m. to 7:00 p.m.; Friday from 8:00 a.m. to 5:00 p.m. Summer hours are Monday through Thursday from 7:30 a.m. to 7:00 p.m.; closed on Friday.

Volunteerism

Volunteerism gives students valuable experience while providing organizations with needed human resources. Volunteerism may be done as an individual experience; as a group or college-wide experience; or through Student Life and Leadership as a community service project.

The Student Life and Leadership Office maintains a list of nonprofit organizations in Maricopa County that welcome student volunteers. The office also sponsors an annual Volunteer Fair in October to give students an opportunity to meet with representatives of these organizations.

In addition, the Student Life and Leadership Office and Student Leadership Forum sponsor at least two college-wide community service projects during the school year. During the fall semester, Make A Difference Day is scheduled for October 20-21. During the spring semester, Into the Streets is scheduled on March 23. To participate, contact the Student Life and Leadership Office in the Student Center Building, Room 185 or call (480) 423-6556.

Voter Registration

Mail-in applications are available from the Admissions (SS136), Advisement (SC118), and Student Life and Leadership (SC185) offices, in both English and Spanish. Registration is also available via the Internet at: www.sosaz.com.

Women's Athletics

Scottsdale Community College is a member of the National Junior College Athletic Association. Women may participate in cross country, soccer, volleyball and basketball during the fall semester. The spring semester continues with basketball adding tennis, softball, golf, and track and field. SCC women's teams have competed in national competitions in volleyball, basketball, tennis, track and field, and golf. Please contact the Athletic Department, (480) 423-6606, for more information.

Student Services

STUDENT LIFE & LEADERSHIP SPECIAL PROJECTS

Date	Event	Time	Location
August 19	New Student Orientations Two Sessions Available	9 am & 1 pm	Performing Arts Center
September 6	SLF's Fall Club Fair	11 am - 1 pm	Cafeteria - Student Center
September 18-22	SLF's Clothesline Across Campus	All Day, All Week	Center Green - Student Center
September 21	SLF's Lunch with Dr. DeCabooter & the Deans	11:30 am	Turquoise Room
September 22*	Fall District Student Leadership Training Workshop	8 am - 5 pm	TBD
October 4	Volunteer! Fair	11 am - 1 pm	Foyer - Student Center
October 20 & 21	SCC's Make A Difference Day	9 am	Off-campus
October 25	SLF's Hocus Pocus Halloween	10 am - 2 pm	East Patio - Student Center
November 15	SLF's Fall Follies	10 am - 2 pm	Center Green - Student Center
December 6	Empty Bowls	11 am - 7 pm	Cafeteria - Student Center
December 14 (Exec/SALs ONLY)	SLF Semester Retreat	9 am	Off-campus
January 12 (Employees ONLY)	College to the Community	8 am	Off-campus
January 13	Spring Orientation	9 am	Student Center
January 24	SLF's Spring Club Fair	11 am - 1 pm	Cafeteria - Student Center
February 14	SLF's Valentine Workshop	10 am - 2 pm	Cafeteria - Student Center
March 1	SLF's Lunch with Dr. DeCabooter & the Deans	11:30 am	Turquoise Room
March 23	Into the Streets	9 am	Off-campus
April 11	Excellence Under the Stars	7 pm	West Green - Student Center
April 25	Spring Fling	10 am - 2 pm	Center Green - Student Center
April 26	Student Club & Organization Recognition Luncheon	12 noon	Artichoke Grill
May 11	Commencement	7 pm	Gymnasium
May (14)15-20*	LeaderShape	Overnight	ASU Polytechnic

Student Life & Leadership Student Leadership Forum Special Projects 2006-2007 "Helping Students Make Things Happen"

**tentative*

For more information, please contact: (480) 423-6538, or stop by the Student Life & Leadership Office in SC-185.

CAMPUS POLICIES

Bookstore Policies

Check Writing

1. The check must be written for the exact amount of the purchase payable to the SCC Bookstore, and only in-state checks are accepted.
2. A current Arizona driver's license must be presented with your bank's imprinted personal check.
3. Your current street address and telephone number must be printed on the check.
4. When using a parent's check, the account holder's driver license number and expiration date must be written across the top of check.
5. There will be a \$20.00 bank penalty for returned checks.
6. In addition, the Bookstore accepts cash, MasterCard, Visa, American Express and Discover Card.

Bookstore Refund Policy

1. All refunds must be accompanied by a valid sales receipt.
2. New and used textbooks may be returned for full refund within seven (7) days from the start of the fall and spring semesters.
3. After the seven-day period, textbooks may be returned for a full refund within two (2) days of purchase.
4. Textbooks may be returned for the full refund seven (7) days from and including the official start of each summer session.
5. No refunds are allowed on new or used textbooks purchased within the last two (2) weeks of classes and the week of finals during any semester or summer session.

Buyback Policy

Bookstore will not buy back books if:

1. Instructor has not authorized re-use of book or has not indicated it will be used next term.
2. Bookstore is overstocked.
3. Publisher has a new edition and prior edition has no value.
4. Book is too ragged and in an unsalable condition.
5. Book has a limited nationwide demand.

Bookstore Hours

Monday through Thursday from 8:00 a.m. to 7:00 p.m.; Friday from 8:00 a.m. to 4:00 p.m.; summer hours are Monday through Thursday from 8:00 a.m. to 7:00 p.m. Visit the Bookstore website at www.scottsdale.bkstr.com.

Bulletin Board Policy

All materials posted on college bulletin boards and kiosks must be stamped for approval by the Student Life and Leadership Office. Materials that have not been approved will be removed.

College Safety Policies

Accidents on Campus

It is important that College Safety be notified of accidents that take place in the classroom or any other area of the college as soon as possible. All accidents must be documented by College Safety. The situation will also be assessed with the intent of referring students/staff for further medical attention.

Most students are covered by MCCCDC student insurance. The insurance forms are processed through the Dean of Student Services Office.

After Hours

Students are not allowed inside College buildings after normal classroom hours without a staff person present.

Campus Hours

The campus opens at 6:00 a.m. and closes at 11:00 p.m. every day.

Emergency Evacuation Procedures

When a building fire alarm sounds, or another emergency exists requiring the evacuation of a building, all persons must immediately exit the building in an orderly manner.

Contact College Safety by dialing (480) 423-6175 or by using a Blue Light security phone. If emergency personnel are required, call 9-1-1 immediately from an outside location away from the building; then remain clear of the building so that emergency personnel can safely approach the scene.

Emergency Vehicle Assistance

The College Safety Office will assist persons with vehicles requiring jump starts and persons locked out of their vehicles. Contact College Safety at (480) 423-6175.

Lost and Found

The College Safety Office is responsible for lost and found property on the SCC campus. If you have lost or found an item, please contact College Safety in Room LB-152, northeast corner of the Library Building, or call (480) 423-6175 or 423-6529.

Parking Regulations

The following parking regulations are those most frequently encountered on the SCC campus. A complete copy of the District Parking and Traffic Regulations is available from the College Safety Office or the Dean of Student Services Office.

1. Parking is permitted within designated parking areas. Student parking permits are not required.
2. Parking is not permitted on grass, unpaved areas or on sidewalks.
3. Vehicles parking in STAFF parking spaces must display a valid permit.
4. Parking in HANDICAPPED parking spaces is reserved for vehicles displaying valid permits or license plates.
5. The maximum speed limit in parking lots is 15 MPH.
6. Parking or leaving a vehicle unattended in a red curb fire lane is prohibited.
7. Pull-through or back-in parking is prohibited.

Students who violate the Traffic and Parking Regulations may be fined and/or disciplined in accordance with the guidelines established by the MCCCDC Governing Board. See the Tuition and Fees Schedule for the list of parking violations and fines. The College Safety Office is open 24 hours, seven days a week.

Fundraising Policy

All clubs/organizations planning fundraising events on campus must complete and submit a Fundraising Request Form. The form is available in the Student Life and Leadership Office and must be submitted along with the Facility Request Form no later than three weeks before the event is to take place. No project or event may take place until the Fundraising Form has been approved.

The Student Life and Leadership Office is located on the north side of the Student Center Building, Room 185 (next to the Cafeteria), and is open Monday through Thursday from 8:00 a.m. to 7:00 p.m.; Friday from 8:00 a.m. to 5:00 p.m.; summer hours are Monday through Thursday 8:00 a.m. to 7:00 p.m. Please call (480) 423-6538 for additional information.

Weapons on Campus Policy

Scottsdale Community College is located on the Salt River Pima-Maricopa Indian Reservation. All weapons, regardless of type, are prohibited by federal and tribal law. The State of Arizona-issued Permit to Carry Concealed Weapon is not valid on the Salt River Pima-Maricopa Indian Reservation, and weapons of any type will be confiscated by Salt River Police.

Discrimination Complaint Procedures for Students

Internal Complaint Procedure

This procedure provides a means for resolving complaints by students who believe they have been adversely affected by illegal or prohibited discrimination by the Maricopa County Community College District (MCCCD), a member college or center, or their students or employees.

Complaints may be brought under this procedure for discrimination based on race, color, religion, national origin, sex (including pregnancy discrimination and sexual harassment), sexual orientation, age, Vietnam-era veteran status, and physical or mental disability.

Students who believe they are experiencing sexual harassment may utilize the report process (as described below) in addition to the Informal and Formal Resolution processes.

All deadlines prescribed for report, Informal Resolution and Formal Resolution processes may be extended by the Vice President of Student Affairs for good reason, such as (but not limited to) when classes are not in session or upon mutual agreement by the parties.

Information related to MCCCD's Discrimination Complaint procedure for Students is also available from the Office of General Counsel at 480-731-8876.

A. Informal Resolution of Discrimination Complaints

1. Before filing a formal complaint under this procedure, a student may attempt to resolve the problem through informal discussions with the person claimed to have engaged in discriminatory conduct and that person's supervisor or department head. The student may choose to ask the Vice President of Student Affairs to assist in the informal resolution process. The Vice President of Student Affairs may designate an employee to provide such assistance. The Vice President of Student Affairs may modify or reject an informal resolution of a complaint of discriminatory conduct under this process if, in the judgment of the Vice President, the resolution that is proposed is not in the best interests of both the student and the institution. The Vice President shall take such action no later than fifteen (15) calendar days after receiving notice of the informal resolution.
2. Attempts to informally resolve alleged discrimination should occur within ninety (90) calendar days of the most recent alleged discriminatory act. For complaints dealing with alleged discrimination beyond the 90-day timeframe, a student must submit a written complaint under the formal resolution procedure of this policy.
3. If the complaint cannot be informally resolved to the satisfaction of the complainant, the complainant has the right to file a written complaint within 300 days of the most recent alleged discriminatory act and to proceed under formal resolution procedures.

B. Formal Resolution of Discrimination Complaints

1. A student who contends that unlawful or MCCCD-prohibited discrimination has occurred may file a formal complaint by contacting the Vice President of Student Affairs at each respective college or center. The Vice President of Student Affairs will accept complaint filings within 300 calendar days of the most recent occurrence of the alleged discriminatory act.
2. A complaint must be signed by the student and filed on the form prescribed by the Office of General Counsel. A student may also contact the Office of General Counsel to obtain the name and phone number of the college or center official designated to respond to discrimination complaints.
3. The complaint must identify the action, decision, conduct, or other basis that constituted an alleged act or practice of unlawful

or MCCCD-prohibited discrimination. The complaint must also allege that the action, decision, or occurrence was taken or based on the complainant's race, color, religion, sex, sexual orientation, national origin, citizenship, age, disability, Vietnam-era veteran status, or any other unlawful discriminatory grounds.

4. Upon receipt of a complaint, the Vice President of Student Affairs will notify the college president or provost and the Office of General Counsel. The Office of General Counsel will assign a case number to the complaint.
5. A copy of the complaint will be shared with the respondent within five (5) working days of receipt by the Vice President of Student Affairs. Respondent will be put on notice that retaliation against the complainant or potential witnesses will not be tolerated and that an investigation will be conducted.
6. Respondent must provide a written response to the complaint within fifteen (15) calendar days of his or her receipt of the complaint.
7. After accepting a complaint, the Vice President of Student Affairs will designate a complaint investigator to conduct a fact-finding investigation which will include, at a minimum, a review of written evidence (including the complaint and response), and interviews with appropriate employees and students. The Vice President of Student Affairs may serve as complaint investigator. Within ninety (90) calendar days following receipt of the complaint, the complaint investigator shall deliver to the Vice President of Student Affairs the investigator's written findings and the results of the investigation, including summaries of all interviews and all documents received as part of the investigation. Within ten (10) working days following receipt of the results of the investigation from the complaint investigator, the Vice President of Student Affairs will submit to the President or Provost the investigator's written findings and the Vice President's recommendations as to the disposition of the complaint.
8. The president or provost will accept, reject, or modify the recommendations and will provide a written notification of his or her action to the complainant and respondent within fifteen (15) calendar days of receiving the written findings and recommendations from the Vice President of Student Affairs.
9. When the investigation confirms the allegations, appropriate corrective action will be taken. Evidence which is collateral to the allegations of discrimination and/or sexual harassment and which was obtained during an investigation may be used in subsequent grievance or disciplinary procedures.

C. MCCCD Administrative Review Process Request for Reconsideration

1. A complainant or respondent who is not satisfied with the decision of the president or provost has ten (10) working days to request, in writing, administrative review of the decision, by his or her college president or provost.
2. The request for administrative review must state specific reasons why the complainant or respondent believes the finding was improper.
3. The president or provost will review the results of the investigation and written findings and respond to the request within ten (10) working days from receipt of the request.
4. If the president or provost determines that the decision is not supported by the evidence, the case file will be reopened and assigned for further investigation.
5. If the president or provost determines that the investigation was thorough and complete and that the decision is supported by the

Continued next page...

College Environment

evidence, he or she will deny the request for administrative review. At this point, the complainant has exhausted the Internal Discrimination Complaint Procedure.

D. Maintenance of Documentation

Documentation resulting from each level in the Formal Resolution Process (including witness statements, investigative notes, etc.) will be forwarded to and maintained by the MCCCC Office of General Counsel. Investigative records are not to be maintained with or considered as a part of a student record. Documentation regarding corrective action is considered part of the student's record.

E. Right to Assistance

A complainant or respondent may receive the assistance of an attorney or other person at any stage of a complaint filed under this Internal Discrimination Complaint Procedure. Such person may attend any investigative interview and advise the complainant or respondent but shall not otherwise participate in the interview. The complaint investigator shall direct communications directly to the complainant and respondent, and not through such individual's attorney or other person providing assistance.

F. Confidentiality of Proceedings

Every effort will be made by the college and MCCCC to protect the confidentiality of the parties during the processing of complaints under this procedure. Records will be maintained in a confidential manner to the extent permitted by law and insofar as they do not interfere with MCCCC's legal obligation to investigate and resolve issues of discrimination.

G. Retaliation Prohibited

Retaliation against a person who has filed a complaint or against any witness questioned during an investigation is strictly prohibited. Any retaliatory action by instructors, supervisors, managers, academic professionals, administrators, or other employees who have the authority to take adverse action against a complainant or witness is prohibited and may be grounds for disciplinary action.

H. False Statements Prohibited

Any individual who knowingly provides false information pursuant to filing a discrimination charge or during the investigation of a discrimination charge will be subject to appropriate discipline.

Filing a Report of Sexual Harassment

A student who believes that he or she is, or has been, the victim of sexual harassment as prohibited by MCCCC policy may report (either orally or in writing) the harassment to the Vice President of Student Affairs at each college or center. The report should be made within 180 calendar days of the most recent alleged incident of sexual harassment. Upon receipt of the report, the Vice President of Student Affairs or designee will have a meeting with the alleged harasser. The meeting shall include: identifying the behavior as described in the report, alerting the alleged harasser to the perception of the impact of his or her behavior, providing the individual with a copy of the MCCCC Sexual Harassment Policy, encouraging completion of the Office of General Counsel's Sexual Harassment Online Tutorial, and encouraging greater awareness of behaviors that may lead to perceptions of sexual harassment. Neither the report nor the meeting with the alleged harasser shall in any way constitute a finding of sexual harassment. The name of the complainant shall not be identified to the respondent during the report process; however, complainants should be aware that they may be called as witnesses in subsequent disciplinary or due process proceedings, as well as in litigation. The meeting with the alleged harasser must be conducted within ten (10) working days of receipt of the report.

External Filing of Discrimination Complaints

MCCCC encourages students to use the MCCCC Discrimination Complaint Procedure for students to resolve discrimination concerns. Students also have the right to file civil rights complaints with appropriate external agencies. No retaliation will be taken against a person for filing a complaint with an external agency. The following agency accepts discrimination charges filed by, or on behalf of, students:

Office for Civil Rights, Region VIII (OCR)
Denver Office
U.S. Department of Education
Federal Building
1244 Speer Boulevard, Suite 310
Denver, Colorado 80204-3582
Phone: 303-844-5695
Fax: 303-844-4303
TDD: 303-844-3417
E-mail: OCR_Denver@ed.gov

Procedimientos de Quejas de Discriminación para Estudiantes

Este procedimiento provee un medio para resolver quejas hechas por estudiantes que creen que han sido afectados negativamente por discriminación de MCCCC ilegal o prohibida por el colegio/centro, MCCCC, o sus estudiantes o empleados.

Quejas pueden ser introducidas bajo este procedimiento por discriminación basada en raza, color, religión, origen sexual, edad, estado de veterano de la era-vietnamesa e incapacidad física o mental.

Estudiantes que creen que están experimentando acosamiento sexual pueden utilizar el proceso de Reporte (como descrito a continuación) además de los Procesos de Resolución Formales e Informales.

Todos los tiempos de vencimiento prescritos para el Reporte, Resolución Informal y Procesos de Resolución Formal pueden ser extendidos por el Vice Presidente de Asuntos Estudiantiles por buena razón, tal como (pero no limitado a) cuando las clases no están en sesión o cuando los partidos están en mutuo acuerdo.

Información relacionada al Procedimiento de Quejas de Discriminación para Estudiantes también es disponible de parte de la Oficina del Cónsul General al 480-731-8876.

A. Resolución Informal de Quejas de Discriminación

1. Antes de archivar una queja formal bajo este procedimiento, un estudiante puede intentar resolver el problema por medio de pláticas informales con la persona declarada de ser responsable por la acción discriminatoria y el supervisor de esa persona o el ejecutivo de ese departamento. El estudiante puede pedirle al Vice Presidente de Asuntos Estudiantiles a que le asista en el proceso de resolución informal. El Vice Presidente de Asuntos Estudiantiles puede modificar o rechazar una resolución informal de una queja de conducta discriminatoria bajo este proceso si, de acuerdo al juicio del Vice Presidente, la resolución propuesta no está en los mejores intereses de ambos estudiante y la institución. El Vice Presidente tomará tal acción a no más tardar (15) días del calendario después de recibir la noticia de resolución informal.
2. Intentos de resolver informalmente discriminación declarada debe de ocurrir dentro de noventa (90) días del calendario después del acto de discriminación declarado.

College Environment

3. Si la queja no puede ser resuelta informalmente para la satisfacción del demandante, el demandante tiene el derecho de archivar una queja escrita dentro de 300 días del acto discriminatorio más recientemente declarado y de proceder bajo procedimientos de resolución formal.

B. Resolución Formal de Quejas de Discriminación

1. Un estudiante que contiene que ha ocurrido discriminación de MCCCDC ilegal o prohibida, puede archivar una queja formal al comunicarse con el Vice Presidente de Asuntos Estudiantiles en cada colegio respectivo o centro. El Vice Presidente de Asuntos Estudiantiles aceptará quejas archivadas dentro de 300 días del calendario de la ocurrencia más reciente del declarado acto discriminatorio.
2. Una queja debe de ser firmada por el estudiante y archivada en la forma prescrita por la oficina del Cónsul General. Un estudiante también puede comunicarse con la oficina del Cónsul General para obtener el nombre y el número de teléfono del oficial del recinto del colegio designado para responder a quejas de discriminación.
3. La queja debe de identificar la acción, decisión, conducta, u otra base que constituya un acto declarado o práctica de discriminación prohibida o ilegal por MCCCDC. La queja también debe de declarar que la acción, decisión u ocurrencia fue hecho o basado de acuerdo a la raza, color, religión, sexo, orientación sexual, origen nacional, ciudadanía, edad (mayor de 40) incapacidad física, estado de era de Vietnam, o cualquier otra causa de discriminación ilegal.
4. Al recibir una queja, el oficial notificará al presidente del colegio o el director y la oficina del Cónsul General. La Oficina del Cónsul General asignará un número de caso a la queja.
5. Una copia de la queja será compartida con el demandado dentro de cinco (5) días de trabajo de recibir la queja por el Vice Presidente de Asuntos Estudiantiles. El demandado será advertido que represalias contra el demandante o testigo oficial no serán toleradas y que una investigación será conducida.
6. El demandado debe de proveer una respuesta por escrito a la queja dentro de quince (15) días del calendario después de recibir la queja.
7. Después de aceptar una queja, el Vice Presidente de Asuntos Estudiantiles conducirá una investigación para encontrar los hechos que incluirá, por lo mínimo, un resumen de la evidencia escrita (incluyendo la queja y la respuesta), y entrevistas con los empleados y estudiantes apropiados. El Vice Presidente de Asuntos Estudiantiles puede servir como investigador de quejas. Dentro de noventa (90) días del calendario después de recibir la queja, el investigador de quejas, le entregará al Vice Presidente de Asuntos Estudiantiles los resultados escritos y los resultados de la investigación. Dentro de diez (10) días de trabajo al recibir los resultados de la investigación de investigador de quejas, el Vice Presidente de Asuntos Estudiantiles le entregará al presidente o Director del Colegio los resultados escritos del investigador y las recomendaciones del Vice Presidente en cuanto a la disposición de la queja.
8. El presidente o director aceptará, rechazará, o modificará las recomendaciones y proveerá una notificación por escrito de su acción a los partidarios dentro de quince (15) días del calendario al recibir los resultados y recomendaciones del Vice Presidente de Asuntos Estudiantiles.
9. Cuando la investigación confirme las alegaciones, acción correctiva apropiada será llevada a cabo. Evidencia que sea colateral a las alegaciones de discriminación y/o de acoso sexual y que fue obtenida durante una investigación bajo estos procedimientos, puede ser usada con quejas subsecuentes o en procedimientos de disciplina.

C. Proceso de Resumen Administrativo de MCCCDC Solicitud de Reconsideración

1. Un demandante o demandado/a que no esté satisfecho/a con la decisión del presidente o director tiene diez (10) días de trabajo para hacer petición, por escrito, un resumen administrativo de la decisión, por su presidente o director del colegio.
2. La petición para resumen administrativo debe declarar razones específicas porque el demandante o el/la demandado/a cree que el resultado fue impropio.
3. El presidente o el director hará resumen de los resultados de la investigación y de los hallazgos escritos y responderá a la petición dentro de diez (10) días de trabajo después de recibir la petición.
4. Si el presidente o el director determina que la decisión no es apoyada por la evidencia, el archivo de caso será abierto de nuevo y asignado para investigación adicional.
5. Si el presidente o el director determina que la investigación fue entera y completa, y que la decisión es apoyada por la evidencia, el o ella negará la petición para resumen administrativo. A este nivel, el demandante ha agotado el Procedimiento de quejas de Discriminación Interna.

D. Mantenimiento de Documentación

Documentación resultando de cada nivel en el Proceso Formal de Resolución (incluyendo declaraciones de testigos, notas investigadoras, etc.) será enviada a y mantenida por la oficina de MCCCDC del Cónsul General. Documentos Investigadores no serán mantenidos con o considerados como parte de los archivos del estudiante. Documentación con respecto a acción correctiva es considerada parte del archivo del estudiante.

E. Derecho a ayuda

Un/Una demandante o demandado/a puede recibir la ayuda de un abogado u otra persona durante cualquier periodo de la queja archivada bajo este Procedimiento de Queja de Discriminación. Tal persona puede asistir a cualquier entrevista y aconsejar al demandante o demandado pero no podrá de otra manera participar en la entrevista. El investigador del demandante hará comunicaciones directamente al demandante y al demandado, y no por medio del abogado del individuo o por otra persona proveyendo asistencia.

F. Confidencialidad de Procedimientos

Cada esfuerzo se hará por el colegio y MCCCDC para proteger la confidencialidad de los grupos durante el procesamiento de quejas bajo este procedimiento. Los archivos serán mantenidos en una manera confidencial al extremo permitido por ley hasta el punto en que no intervengan con la obligación legal de MCCCDC de investigar y resolver asuntos de discriminación.

G. Represalia prohibida

Represalia contra una persona quien ha archivado una queja o contra cualquier testigo interrogado durante una investigación está estrictamente prohibido. Cualquier acto de represalia por instructores, supervisores, gerentes, profesionales académicos, administradores, u otros empleados quienes tienen la autoridad para llevar a cabo acción adversa contra un demandante o testigo, está prohibido, y puede ser motivo para acción disciplinaria.

H. Declaraciones Falsas Prohibidas

Cualquier individuo que al saber provee información falsa después de archivar un cargo de discriminación o durante la investigación de un cargo de discriminación será sujeto a disciplina apropiada.

Archivando un Reporte de Acosamiento Sexual

Un estudiante que cree que él o ella es, o ha sido la víctima de acosamiento sexual según prohibido por los reglamentos de MCCCC, puede Reportar (oralmente o por escrito) el acosamiento al Vice Presidente de Asuntos Estudiantiles en cada colegio o centro. El Reporte debe ser hecho dentro de 180 días del calendario a partir del incidente más reciente del acosamiento sexual. Al recibir el Reporte, el Vice Presidente de Asuntos Estudiantiles o designado tendrá una junta con el acosador implicado. La junta incluirá: identificar el comportamiento como descrito en el Reporte, avisando al acosador declarado en cuanto a la percepción del impacto de su comportamiento, proveyendo al individuo con una copia de los Reglamentos de Acosamiento Sexual de MCCCC, animando el completar el Seminario de Acosamiento Sexual usando la red que es patrocinado por la Oficina de Cónsul General y animando más atención a los comportamientos que puedan llevar a uno a percepciones de acosamiento sexual. Ni el Reporte o la junta con el acosador implicado de cualquier manera constituirá un hallazgo de acosamiento sexual. El nombre del acosador no será identificado al demandado durante el proceso del Reporte; pero, los acusadores deben de darse cuenta que podrán ser llamados testigos en procedimientos disciplinarios subsecuentes o proceso legal, tanto como en litigación. La junta con el acosador implicado debe de ser conducida dentro de diez (10) días de trabajo después del recibimiento del Reporte.

Archivo Externo de Queja de Discriminación

MCCCC anima a estudiantes a usar los Procedimientos de Quejas de Discriminación de MCCCC para que los estudiantes puedan resolver asuntos de discriminación. Los estudiantes también tienen el derecho de archivar quejas de derechos civiles con las agencias externas apropiadas. No habrá represalia contra una persona que archiva una queja con una agencia externa. La siguiente agencia acepta cargos de discriminación archivados por, o favor de, estudiantes:

Office for Civil Rights, Region VIII (OCR)
Denver Office
U.S. Department of Education
Federal Building
1244 Speer Boulevard, Suite 310
Denver, Colorado 80204-3582
Phone: 303-844-5695
Fax: 303-844-4303
TDD: 303-844-3417
E-mail: OCR_Denver@ed.gov

Sexual Harassment Policy (AR 2.4.4 & 5.1.8-17)

The policy of the Maricopa Community Colleges is to provide an educational, employment, and business environment free of unwelcome sexual advances, requests for sexual favors, and other verbal and/or physical conduct or communications constituting sexual harassment as defined and otherwise prohibited by local, state and federal law.

Sexual harassment by and between employees, students, employees and students, and campus visitors and students or employees is prohibited by this policy.

Violations of this policy may result in disciplinary action up to and including termination of employees, sanctions up to and including suspension or expulsion of students, and appropriate sanctions against campus visitors.

This policy is subject to constitutionally protected speech rights and principles of academic freedom. Questions about this policy may be directed to the Maricopa Community Colleges Equal Employment Opportunity/Affirmative Action (EEO/AA) Office.

Examples of Policy Violations (AR 5.1.9)

It shall be a violation of Maricopa Community College's Sexual Harassment Policy for any employee, student or campus visitor to:

- A. Make unwelcome sexual advances to another employee, student, or campus visitor.
- B. Make unwelcome requests for sexual favors, whether or not accompanied by promises or threats with regard to the employment or academic relationship.
- C. Engage in verbal or physical conduct of a sexual nature with another employee, student or campus visitor that may threaten or insinuate, either explicitly or implicitly, that the individual's submission to, or rejection of, the sexual advances will in any way: (1) influence any personnel decision regarding that person's employment, evaluation, wages, advancement, assigned duties, shifts or any other condition of employment or career development; or (2) influence his or her grades, participation in or access to academic programs, class standing or other educational opportunities.
- D. Engage in verbal or physical conduct of a sexual nature that: (1) has the purpose or effect of substantially interfering with an employee's ability to do his or her job; or with a student's ability to learn or participate in a class; or (2) which creates an intimidating, hostile or offensive work or academic environment.
- E. Commit any act of sexual assault or public sexual indecency against any employee or student whether on Maricopa Community Colleges property or in connection with any Maricopa Community Colleges-sponsored activity.
- F. Continue to express sexual interest in another employee, student or campus visitor after being informed or on notice that the interest is unwelcome (reciprocal attraction is not considered sexual harassment).
- G. Engage in other sexually harassing conduct in the workplace or academic environment, whether physical or verbal, including, but not limited to, commentary about an individual's body (or body parts), sexually degrading words to describe an individual, sexually offensive comments, sexually suggestive language or jokes, innuendoes, and sexually suggestive objects, books, magazines, computer software, photographs, cartoons or pictures.

Additional Policy Violations (AR 5.1.10)

Supervisors, managers, administrators and faculty who disregard or fail to report allegations of sexual harassment (whether reported by the person who is the subject of the sexual harassment or a witness) are in violation of this policy.

Responsibility for Policy Enforcement (AR 5.1.11)

Every Maricopa Community Colleges employee and student must avoid offensive or inappropriate sexual and/or sexually harassing behavior at work or in the academic environment.

Employees and students are encouraged (but not required) to inform perceived offenders of this policy that the commentary/conduct is offensive and unwelcome.

Amorous Relationships (AR 5.1.12)

An amorous relationship that might be appropriate in other circumstances may be inappropriate if one of the individuals in the relationship has a professional responsibility toward, or is in a position of authority with respect to, the other, such as in the context of instruction, counseling, advisement or supervision. An element of power is often present in such a context and it is incumbent upon those with authority not to abuse that power.

College Environment

Complaints (AR 5.1.13)

A. Employees

Employees who experience sexual harassment at work (by a supervisor, co-employee, student or visitor) are urged to report such conduct to the direct attention of their supervisor, their college president or to the Maricopa Community Colleges Equal Employment Opportunity/Affirmative Action Office (480) 731-8885. If the complaint involves the employee's supervisor or someone in the direct line of supervision, or if the employee for any reason is uncomfortable in dealing with his or her immediate supervisor, the employee may go directly to the Maricopa Community Colleges EEO/AA Office.

B. Students

Students who experience sexual harassment in the academic environment (by a faculty member, administrator, campus visitor or other student) are urged to report such conduct to the vice president of student affairs or designee at each individual campus. A student may also contact the Maricopa Community Colleges EEO/AA Office to obtain the name and phone number of the college official designated to respond to sexual harassment complaints.

C. General - Applicable to Both Employees and Students

Complaints will be investigated according to procedures established by the Maricopa Community Colleges EEO/AA Office. Copies of these procedures may be obtained in the college president's office, Office of the Vice President of Student Affairs and the Maricopa Community Colleges EEO/AA Office.

The college/center/MCCCD will investigate all complaints as professionally and expeditiously as possible.

Where investigation confirms the allegations, appropriate responsive action will be taken by the college/center/MCCCD.

Confidentiality (AR 5.1.14)

Records will be maintained in a confidential manner to the extent permitted by law and insofar as they do not interfere with Maricopa Community Colleges' legal obligation to investigate and resolve issues of sexual harassment.

Violations of Law (AR 5.1.15)

An employee or student may be accountable for sexual harassment under applicable local, state, and/or federal law, as well as under Maricopa Community Colleges policy. Disciplinary action by Maricopa Community Colleges may proceed while criminal proceedings are pending and will not be subject to challenge on the grounds that criminal charges involving the same incident have been dismissed or reduced.

False Statements Prohibited (AR 5.1.16)

Any individual who knowingly provides false information pursuant to filing a discrimination charge or during the investigation of a discrimination charge will be subject to appropriate disciplinary action, up to and including employment termination or academic dismissal.

Retaliation Prohibited (AR 5.1.17)

Retaliation against an employee or student for filing a sexual harassment complaint, or participating in the investigation of a complaint, is strictly prohibited. Maricopa Community Colleges will take appropriate disciplinary action, up to and including employment termination or academic dismissal if retaliation occurs.

Petition Signature Solicitation (AR 2.4.8)

- A. This regulation shall govern access to college premises by representatives who wish to solicit signatures on petitions for the purpose of submission of a ballot proposition to voters, or nomination of a candidate for elective office, in a city-, county- or state-wide election.
- B. Each college president shall designate general hours of accessibility for solicitation and a location on college premises where all representatives on behalf of any candidate or ballot proposition may solicit signatures. The location shall be in a common area where the solicitation will not serve as an obstruction to student activities or otherwise disrupt the college environment.
- C. All solicitation must take place in designated areas. Standard space may include one or two tables and chairs. Campus restrictions regarding amplification will apply. Representatives may not distribute or make available to students, employees, or college visitors any tangible item, except for informational literature about the proposed candidate or ballot initiative.
- D. Representatives shall notify the designated official at each college or center of their intent to be present on college premises no fewer than three (3) working days prior to soliciting signatures. Upon obtaining authorization, representatives shall be provided a written version of this regulation.

Solicitation (AR 2.4.9)

A. Definitions

A solicitor is any non-Maricopa Community Colleges-affiliated entity that would, on the premises of any Maricopa Community College or Center, purport to sell or promote any product, service, or idea, but does not include such an entity that would enter the premises for the purposes of promoting, opposing, or soliciting petition signatures in connection with any political candidate or initiative, or referendum ballot.

A special event is a college-sponsored event conducted on college premises for the benefit of students that is based on a particular theme, and for which the college has deemed it essential to invite the participation of solicitors whose products, services or ideas are pertinent to the special event's theme.

B. Requirements

1. A solicitor must notify the designated official at each college or center of their intent to solicit on college or center premises. A solicitor who would purport to sell any product or service is responsible for obtaining any necessary tax licenses and must submit to the designated official a certificate of commercial liability insurance and pay to the college or center, in consideration for the opportunity for solicitation, a fee in the amount of \$50 per day or \$125 per full week.

College Environment

2. Campus restrictions regarding location, time, date, and use of amplification may apply. All requests for space shall be granted on a first-come, first-served basis only upon completion of the requirements contained in this regulation.
3. All solicitation must take place at tables in designated areas. Standard space will be one or two tables and chairs. Solicitors may be limited to no more than fifty (50) hours of solicitation activity per semester at each college or center.
4. By requesting the opportunity for solicitation on the premises of a college or center, a solicitor warrants that it may lawfully sell or promote its product, service or idea and that such activity does not violate any law, and does not violate any trademark, copyright, or similar proprietary interest. The activity of any solicitor may not violate any existing Maricopa contract.
5. The president of every college or center shall establish for such location restrictions governing the activities of solicitors. Such restrictions shall supplement, but shall not replace or waive, this regulation.
6. A college may waive the fee prescribed in this regulation for any solicitor's participation in a special event if the college determines that such participation will be of particular educational benefit to the interests of that college's students; the participation is sponsored by a club, organization, or academic division; and the participation is approved by the college's Student Life and Leadership department. A college may waive both the fee and the insurance certificate requirements prescribed in this regulation for a student purporting to sell or promote a product or service at a special event, provided that:
 - a. Such product or service presents low risk of harm to a potential user;
 - b. The product or service is not food or food-related and;
 - c. The student is soliciting solely on his or her own behalf and not pursuant to any sales agreement, commission agreement, or similar affiliation or contractual relationship with another entity.
7. Any solicitor who violates this regulation may be deemed a trespasser on college or center premises, and therefore subject to appropriate prosecution within the discretion of the College Safety department and other responsible officials at the college or center. The Maricopa County Community College District, its colleges and centers, assume no responsibility—financial or otherwise—for the acts or omissions of any vendor whose presence on college premises pursuant to this regulation is approved by any college official.

Children on Campus (AR 2.4.10)

Children (younger than 18) may not attend any class unless they are officially registered for the class.

Children will not be allowed on campus unless participating in an authorized college program or under the supervision of an adult.

Crime Awareness/Campus Security Act (AR 2.4.11)

Federal legislation requires the college to maintain data on the types and number of crimes on college property as well as policies dealing with campus security. To obtain additional information on this subject, contact the College Safety and Security Department.

Workplace Violence Prevention (AR 2.4.12)

It is the policy of the Maricopa Community Colleges to promote a safe environment for its employees, students, and visitors. The Maricopa Community Colleges are committed to working with its employees to maintain an environment free from violence, threats of violence, harassment, intimidation, and other disruptive behavior.

Violence, threats, harassment, intimidation, and other disruptive behavior in our facilities will not be tolerated, and it is the responsibility of all members of the Maricopa Community Colleges to report any occurrence of such conduct. Every employee, student and visitor on Maricopa Community College District property is encouraged to report threats or acts of physical violence of which he/she is aware. All reports will be taken seriously and will be dealt with appropriately. Such behavior can include oral or written statements, gestures, or expressions that communicate a direct or indirect threat of physical harm.

This policy applies to employees and students, as well as independent contractors and other non-employees doing business with the Maricopa Community Colleges. Individuals who commit such acts may be removed from the premises and may be subject to disciplinary action, criminal penalties, or both. The Chancellor is hereby instructed to enact all administrative regulations necessary to implement this policy.

Student Right to Know (AR 2.4.13)

Under the terms of the Student Right to Know Act, the college must maintain and report statistics on the number of students receiving athletically-related student aid reported by race and sex, the graduation rate for athletes participating in specific sports reported by race and sex, the graduation rate for students in general reported by race and sex, and other similar statistics. To obtain copies of these reports, contact the Office of Admissions and Records.

STUDENT RIGHTS AND RESPONSIBILITIES

Copyright Act Compliance (AR 2.4.5)

Students are expected to comply with the provisions of the Copyright Act of 1976 pertaining to photocopying of printed materials, copying of computer software and videotaping. In order to assist students in complying with the Copyright Law, appropriate notices shall be placed on or near all equipment capable of duplicating copyrighted materials.

Copyright Regulation (AR 3.2)

- A. It is the intent of the Governing Board of the Maricopa County Community College District to adhere to the provisions of the U.S. Copyright Law (Title 17, United States Code, Section 101, et seq.). Though there continues to be controversy regarding interpretation of the Copyright Law, this policy represents a sincere effort by the Board to operate legally within the District.
- B. The Governing Board directs the Chancellor or his designee(s) to develop and distribute to employees guidelines that (1) clearly discourage violation of the Copyright Law and (2) inform employees of their rights and responsibilities under the Copyright Law.
- C. Each college president or provost and the Chancellor shall name an individual(s) at each district location who will assume the responsibilities of distributing copyright guidelines, act as a resource person regarding copyright matter and provide training programs on current copyright laws.
- D. Employees are prohibited from copying materials not specifically allowed by the (1) Copyright Law, (2) fair use guidelines, (3) licenses or contractual agreements, or (4) other permission.
- E. The Governing Board disapproves of unauthorized duplication in any form. Employees who willfully disregard this Board policy and/or the aforementioned copyright guidelines do so at their own risk and assume all liability for their actions.
- F. In order to assist employees and students in complying with the Copyright Law, appropriate notices shall be placed on or near all equipment capable of duplicating copyrighted materials.

What Students Should Know About Copyright

What is copyright?

Copyright is a protection afforded under federal law for various types of creative works. A work is copyrightable if it is an original work of authorship fixed in a tangible medium of expression. Copyrightable works include literary, musical or dramatic works; motion pictures and other audiovisual works; choreographic works and pantomimes; sound recordings; and architectural works.

The owner of a copyright in a particular work has the exclusive right to copy, display, perform, distribute, and create a derivative version of the work. Generally, then this means you may not duplicate, show or perform a copyrighted work unless it is expressly allowed under the Copyright Act or you have the prior permission of the copyright holder.

A copyright exists in a work at the time it becomes fixed in some tangible medium of expression. Neither registration of the copyright with the federal government nor a copyright notice on the work itself is required for copyright protection.

What is copyright infringement?

Generally, copyright infringement occurs when you copy, display, perform, distribute or create a derivative version of a copyrightable work either without the permission of the copyright holder or when such activity is not otherwise allowed under an exception provided by federal copyright law. The penalties for infringement include significant damages—potentially in excess of \$100,000 for each work infringed.

How does copyright law affect information I obtain off the Internet?

Copyright law covers works in both traditional and new media, including digital media. Copyrightable materials are often available on the Internet without any indication of their copyrighted status. As a rule, you should assume that everything you find on the Internet is copyrighted, unless otherwise labeled. Even popular activities, such as file swapping or copying software or pictures from the Internet, may be copyright infringement and should be avoided.

The Digital Millennium Copyright Act, which Congress enacted in 2000, affords greater protection for copyright holders of digital works. Generally, then, even if a work appears solely in a digital form, it is likely subject to copyright law protections.

New technology has made many creative works widely available through the Internet. For example, the technology known as Peer to Peer (P2P) allows for the transmission of music, videos, movies, software, video games and other materials—most of which is subject to copyright protection.

Remember that a copyright exists in a work at the time it becomes fixed in some tangible medium of expression. That means that an image you have downloaded from the Internet, as well as a video or musical performance is almost certainly subject to copyright protection. When you download these works, transfer them to a disk or other medium, or send them to a friend, you are infringing on the rights of the copyright holder. Trafficking in such material without the permission of the copyright holder, then, violates copyright law. This includes unauthorized music file sharing over the Internet.

According to a statement recently issued by representatives of the motion picture, recording and songwriting industries, uploading and downloading copyrighted works over the Internet is theft: It is no different from walking into the campus bookstore and in a clandestine manner walking out with a textbook without paying for it.

Why is it important for a student to be aware of copyright law?

Copyright infringement is expressly prohibited by the U.S. Copyright Act. Anyone who infringes another's copyright in a creative work is subject to liability, and could be required to pay large sums in damages.

In addition, as the law clearly prohibits copyright infringement, using any college resources—such as photocopiers, desktop and laptop computers, printers, central computing facilities, local-area or college-wide networks, Internet access, or electronic mail—for the purpose of infringing a copyright in any work may be grounds for student discipline. According to Maricopa Community College District administrative regulation, Students are expected to comply with the provisions of the Copyright Act of 1976 pertaining to photocopying of printed materials, copying of computer software and videotaping.

Moreover, under the Maricopa Community Colleges Computing Resource Standards, a student is prohibited from the use of software, graphics, photographs, or any other tangible form of expression that would violate or infringe any copyright or similar legally-recognized protection of intellectual property rights. The Standards also prohibit transmitting, storing, or receiving data, or otherwise using computing resources in a manner that would constitute a violation of state or federal law...

A student who violates these policies, then, can be disciplined at any of the Maricopa Community Colleges. This discipline could include suspension or even expulsion.

Continued next page...

Student Rights and Responsibilities

Does copyright law allow me to download files from a college web site?

Thanks to recent changes to copyright law, colleges and universities are allowed to transmit copyrighted images, recordings, and other materials over the Internet in connection with distance learning offerings. These changes allow for the performance of non-dramatic literary works or musical works, as well as the display of reasonable and limited portions of any work in an amount comparable to that typically displayed in a live classroom setting. Use of the works must, however, be an integral part of the distance-learning class session, and available solely to students enrolled in the class. In addition, the transmission of the copyrighted works must be under the direction or actual supervision of a faculty member.

Even though the college does not hold the copyright to these works, or even have the express permission of the copyright holder, they may be delivered over the Internet to students in distance learning classes.

The fact that the law authorizes such use of copyrighted materials, though, does not allow a student in these classes to freely download, copy, or re-transmit the works. They are intended solely for use by the institution in connection with distance instruction; any other use would likely constitute a violation of copyright law.

To learn more about copyright, go to: <http://www.maricopa.edu/legal/> and select Intellectual Property. While you're there, you should read the Maricopa Community Colleges' copyright Guidelines. You should also review the complete text of the Technology Resource Standards, which can be found under the Information Technology link. The Standards also appear in college catalogs and student handbooks.

Taping of Faculty Lectures (AR 3.4)

The Maricopa Community Colleges acknowledge that faculty members are, by law, afforded copyright protection in their classroom lectures and, therefore, may limit the circumstances under which students may tape (audio/visual) their classes.

Each faculty member shall inform his/her students within the first week of class as to his/her policy with regard to taping. Failure to do so will accord students the right to tape lectures.

Students with disabilities that render them unable to take adequate lecture notes are entitled to reasonable accommodation to remedy this inability. Accommodation may require a faculty member to exempt a student from his/her taping policy.

Technology Resource Standards (AR 4.4)

A. Introduction

The Maricopa County Community College District (MCCCD) provides its students and employees access to information resources and technologies. Maricopa recognizes that the free exchange of opinions and ideas is essential to academic freedom, and the advancement of educational, research, service, operational and management purposes, is furthered by making these resources accessible to its employees and students.

At Maricopa, technological resources are shared by its users; misuse of these resources by some users infringes upon the opportunities of all the rest. As Maricopa is a public institution of higher education, however, the proper use of those resources is all the more important. Accordingly, Maricopa requires users to observe Constitutional and other legal mandates whose aims are to safeguard and appropriately utilize technology resources that are acquired and maintained with public funds.

B. General Responsibilities

Technology resources (including, but not limited to, desktop and laptop systems, printers, central computing facilities, District-wide or college-wide networks, local-area networks, access to the Internet, electronic mail and similar electronic information) of the Maricopa County Community College District are available only to authorized users, and any use of those resources is subject to these Standards. All users of Maricopa's technology resources are presumed to have read and understood the Standards. While the Standards govern use of technology resources District-wide, an individual community college or center may establish guidelines for technology resource usage that supplement (but do not replace or waive) these Standards.

C. Acceptable Use

Use of Maricopa's technology resources, including web sites created by employees and students, is limited to educational, research, service, operational, and management purposes of the Maricopa County Community College District and its member institutions. Likewise, images and links to external sites posted on or transmitted via Maricopa's technology resources are limited to the same purposes.

It is not Maricopa's practice to monitor the content of electronic mail transmissions, files, images, links or other data stored on or transmitted through Maricopa's technology resources. The maintenance, operation and security of Maricopa's technology resources, however, require that network administrators and other authorized personnel have access to those resources and, on occasion, review the content of data and communications stored on or transmitted through those resources. A review may be performed exclusively by persons expressly authorized for such purpose and only for cause. To the extent possible in the electronic environment and in a public setting, a user's privacy will be honored. Nevertheless, that privacy is subject to Arizona's public records laws and other applicable state and federal laws, as well as policies of Maricopa's Governing Board, all of which may supersede a user's interests in maintaining privacy in information contained in Maricopa's technology resources.

Frequently, access to Maricopa's technology resources can be obtained only through use of a password known exclusively to the user. It is the user's responsibility to keep a password confidential. While Maricopa takes reasonable measures to ensure network security, it cannot be held accountable for unauthorized access to its technology resources by other users, both within and outside the Maricopa community. Moreover, it cannot guarantee users protection against loss due to system failure, fire, etc.

Much of the data contained in Maricopa records that are accessible through use of technology resources is confidential under state and federal law. That a user may have the technical capability to access confidential records does not necessarily mean that such access is authorized. A user of Maricopa's technology resources is prohibited from the unauthorized access to, or dissemination of, confidential records.

Violation of any provision of the Standards could result in immediate termination of a user's access to Maricopa's technology resources, as well as appropriate disciplinary action. A violation of the Standards should be reported immediately to the appropriate administrator.

Student Rights and Responsibilities

D. Prohibited Conduct

The following is prohibited conduct in the use of Maricopa's technology resources:

1. Posting to the network, downloading or transporting any material that would constitute a violation of Maricopa County Community College District contracts.
2. Unauthorized attempts to monitor another user's password protected data or electronic communication, or delete another user's password protected data, electronic communications or software, without that person's permission.
3. Installing or running on any system a program that is intended to or is likely to result in eventual damage to a file or computer system.
4. Performing acts that would unfairly monopolize technology resources to the exclusion of other users, including (but not limited to) unauthorized installation of server system software.
5. Hosting a web site that violates the .EDU domain request.
6. Use of technology resources for non-Maricopa commercial purposes, including to advertise personal services, whether or not for financial gain.
7. Use of software, graphics, photographs, or any other tangible form of expression that would violate or infringe any copyright or similar legally-recognized protection of intellectual property rights.
8. Activities that would constitute a violation of any policy of Maricopa's Governing Board, including, but not limited to, Maricopa's non-discrimination policy and its policy against sexual harassment.
9. Transmitting, storing, or receiving data, or otherwise using technology resources in a manner that would constitute a violation of state or federal law, or MCCCCD policy or administrative regulation including, but not limited to, obscenity, defamation, threats, harassment, and theft.
10. Attempting to gain unauthorized access to a remote network or remote computer system.
11. Exploiting any technology resources system by attempting to prevent or circumvent access, or using unauthorized data protection schemes.
12. Performing any act that would disrupt normal operations of computers, workstations, terminals, peripherals, or networks.
13. Using technology resources in such a way as to wrongfully hide the identity of the user or pose as another person.
14. Allowing any unauthorized access to Maricopa's technology resources.

E. Disclaimer

The home page of a web site must display, or link to, the following disclaimer in a conspicuous manner:

All information published online by MCCCCD is subject to change without notice. MCCCCD is not responsible for errors or damages of any kind resulting from access to its Internet resources or use of the information contained therein. Every effort has been made to ensure the accuracy of information presented as factual; however, errors may exist. Users are directed to countercheck facts when considering their use in other applications. MCCCCD is not responsible for the content or functionality of any technology resource not owned by the institution.

The statements, comments or opinions expressed by users through use of Maricopa's technology resources are those of their respective authors, who are solely responsible for them, and do not necessarily represent the views of the Maricopa County Community College District.

F. Complaints and Violations

Complaints or allegations of a violation of these standards will be processed through Maricopa's articulated grievance procedures or resolution of controversy.

Upon determination of a violation of these standards, Maricopa may unilaterally delete any violative content and terminate the user's access to Maricopa's technology resources. It is the user's responsibility to demonstrate and/or establish the relevance of content in the event that a content complaint is made official. Users retain the right to appeal through Maricopa's grievance procedures or resolution of controversy.

Hazing Prevention Regulation (AR 2.6)

The Maricopa County Community College District (MCCCCD) strives to exceed the changing expectations of our many communities for effective, innovative, student-centered, flexible and lifelong educational opportunities. Our employees are committed to respecting diversity, continuous quality improvement and the efficient use of resources. We are a learning organization guided by our shared values of education, students, employees, excellence, diversity, honesty and integrity, freedom, fairness, responsibility and public trust.

Central to the vitality and dignity of our community of learners is an environment that produces broadly educated responsible citizens, who are prepared to serve and lead in a free society. Academic instruction, co-curricular activities and community involvement come together to meet this goal. All members of the Maricopa Community Colleges' community, through the best of their abilities, must be provided the opportunity to contribute in a safe, orderly, civil and positive learning environment. One factor that inhibits the achievement of the above stated purpose is the practice of hazing.

1. Hazing by any student, employee or other person affiliated with the Maricopa Community Colleges is prohibited.
2. Hazing is defined as any intentional, knowing or reckless act committed by a student or other person in any MCCCCD college or affiliated educational setting, whether individually or in concert with other persons, against another student, and in which both of the following apply:
 - a. The act was committed in connection with an initiation into, an affiliation with, or the maintenance of membership in any club/organization that is affiliated with Maricopa Community Colleges; and
 - b. The act contributes to a substantial risk of potential physical injury, mental harm or personal degradation, or causes physical injury, mental harm or personal degradation.
3. Any solicitation to engage in hazing is prohibited.
4. Aiding and abetting another person who is engaged in hazing is prohibited.
5. Victim consent is not a defense for violation of the Maricopa Community Colleges Hazing Prevention Regulation.
6. All students, faculty and staff must take reasonable measures within the scope of their individual authority to prevent violations of the Maricopa Community Colleges Hazing Prevention Regulation.

Continued next page...

Student Rights and Responsibilities

7. Hazing activities and situations include, but are not limited to, the following:
 - a. Pre-pledging, illegal pledging or underground activities.
 - b. Acts of mental and physical abuse, including, but not limited to: paddling, slapping, kicking, pushing, yelling, biting, duck-walking, line-ups, tuck-ins, belittling, excessive exercise, beating or physical abuse of any kind, and the potentially forced consumption of any food or beverage that contributes to or causes physical injury, mental harm or personal degradation.
 - c. Sleep deprivation (activities that deprive prospective and/or current students and/or members of the opportunity of a minimum of six hours sufficient sleep each day).
 - d. Encouraging or forcing use of alcohol or drugs.
 - e. Any type of student club/organization scavenger hunt, quest, road trip or activity that would physically or psychologically endanger prospective and/or current students and/or members or others.
 - f. Stroking or physically touching in an indecent or inappropriate manner. See Sexual Harassment Policy (AR 5.1.8).
 - g. Student club/organization activities that subject prospective and/or current students and/or members or others to public nuisance or spectacle.
 - h. Aiding or abetting theft, fraud, embezzlement of funds, destruction of public, personal or private property, or academic misconduct.
 - i. Being required to wear odd or look-alike apparel that contributes to or causes physical injury, mental harm or personal degradation.
 - j. Personal services that contribute to or cause physical injury, mental harm or personal degradation.

8. Alleged violations of this regulation by students or student organizations can be reported to the vice president of student affairs' office for investigation by any member of the college community. The vice president of student affairs' office will investigate the complaint in accordance with the student disciplinary code, all other college and Maricopa Community Colleges policies, and local and state laws.

Alleged violations of the Maricopa Community Colleges hazing prevention regulation or interference with an investigation under this regulation by students or student organizations are subject to sanctions under the student disciplinary code (AR 2.5.2).

The student disciplinary code shall govern all proceedings involving such a complaint. Decisions arrived at as outcomes of the proceedings shall be final, pending the normal appeal process.

9. Alleged violations of the Maricopa Community Colleges hazing prevention regulation by any faculty or staff member can be reported to the vice president of student affairs' office for investigation by any member of the college community. The vice president of student affairs' office will investigate the complaint in accordance with college and Maricopa Community Colleges policies, and local and state laws.

Any Maricopa Community Colleges faculty or staff member who knowingly permitted, authorized or condoned the alleged hazing activity is subject to disciplinary action in accordance with college and Maricopa Community Colleges policies, and local and state laws.

10. If the vice president of student affairs' office receives a report or complaint of an alleged hazing activity involving physical injury, threats of physical injury, intimidation, harassment or property damage, or any other conduct that appears to violate Arizona state law, the college will report such conduct to the appropriate college safety office. The said college safety office will investigate, respond

to and report on the alleged hazing activity in accordance with all college, district, local, state and federal guidelines, policies and laws.

11. Should the proceedings outlined above substantiate an occurrence of hazing activity—where students or student organizations knowingly permitted, authorized or condoned the hazing activity—the college can recommend the following sanctions against student clubs/organizations.
 - a. Censure: Censure can include the required completion of a program designed with the intent of eliminating the hazing activity. The programs will be devised with the cooperation of all involved parties and monitored by the vice president of student affairs' office.
 - b. Probation: The student club(s)/organization(s) will be placed on probation for a specified period of time. Conditions of probation will be determined by the vice president of student affairs' office and outlined in writing to the student club(s)/organization(s). The probationary term will be monitored by the vice president of student affairs' office.
 - c. Suspension: The student club(s)/organization(s) will be suspended. The terms of the suspension can be defined in the sanction, including criteria the student club(s)/organization(s) must meet within a specified time to be considered for admission or renewal of college recognition status.
 - d. Revocation: The student club(s)/organization(s) will have its status revoked, with the loss of all college associations, recognitions and privileges. The national or international office of an organization, if so affiliated, will be requested to revoke the charter of an organization.
12. The Maricopa Community Colleges hazing prevention regulation is not intended to prohibit or sanction the following conduct:
 - a. Customary athletic events, contests or competitions that are sponsored by any of the Maricopa Community Colleges.
 - b. Any activity or conduct that furthers the goals of a legitimate educational curriculum, a legitimate co-curricular experience or a legitimate military training program.
13. For the purposes of the Maricopa Community Colleges hazing prevention regulation: Organization is defined as an athletic team, association, order, society, corps, cooperative, club or other similar group that is affiliated with Maricopa Community Colleges, whose membership consists primarily of students enrolled at Maricopa Community Colleges and that may also be classroom-related or co-curricular in nature.

Abuse-Free Environment (AR 2.4.7)

A. Substance Abuse/Misuse Statement

Drug abuse and misuse has become a national issue and is receiving national attention, particularly in the academic community. The insidious effects of the abuse of these agents are also felt by all walks of life and economic levels. Therefore, as an education providing institution, we are responsible to provide knowledge and guidelines about prevention, control, and treatment of the abuse/misuse of alcohol, illegal and legal drug uses and misuses.

This policy statement has been constructed on the belief that higher education has a responsibility to face safety and health factors of substance abuse/misuse issues forthrightly and innovatively. We believe that the community college needs to adapt programs applicable to their community as well as to our individual student's needs. The policy statements should be comprehensive, understood by those expected to comply, realistic and enforceable, consistently applied, and cover foreseeable dangers.

Student Rights and Responsibilities

Construction of this statement has been founded on concerns of individual safety, educational quality, and legal liability. It is recognized that each individual is responsible for his/her actions and must be afforded an opportunity to develop knowledge, skills and talent, and be willing to share community responsibilities. The Maricopa Community College District has an equal duty to care responsibility and a commitment to substance abuse/misuse education for all students and employees.

The Maricopa Community College District shall:

1. Visibly demonstrate a performance of the Maricopa Community College District duty to care.
2. Comply with requirements for federal funds.
3. Describe what the college does about substance abuse/misuse (alcohol, drugs, anabolic steroids).
4. Inform/educate members of the academic community of adverse effects of these substances.
5. Inform/educate the academic community about the policies concerning substance misuse and abuse.
6. Discourse illegal drug abuse and legal substance misuse.
7. Provide individual and group counseling.
8. Provide assistance and guidance to obtain treatment and rehabilitation of any identified problem.

To achieve these objectives, the program must provide an environment capable of:

1. Developing and implementing substance misuse/abuse prevention programs.
2. Providing educational training and prevention programs for the college and community it serves.
3. Providing timely and accurate information dissemination.
4. Establishing supportive counseling programs as needed.
5. Establishing a strong on-going evaluation of services.
6. Providing assistance to obtain treatment and rehabilitation of substance abuse/misuse.
7. Clarifying the college regulations for control of alcohol and drug use.
8. Providing procedures that the college will follow to correct and stabilize emergency situations.

Each college will identify key people to provide emergency services and to contact and work with outside agencies.

The Maricopa Community College District is committed to establishing a preventative substance abuse program at each college designed to affect positively the problems of irresponsible use of alcohol and the use and abuse of illegal substances. A main focus of the program will be on education of the campus community and assistance to individuals.

The Maricopa Community College District fully supports disciplinary action for misconduct and the enforcement of state laws governing the use of alcohol and the use, abuse, possession or distribution of controlled substances or illegal drugs.

B. Student Program to Prevent Illicit Use of Drugs and Abuse of Alcohol

1. Introduction and Purpose

The recent adoption by Congress of the Drug-Free Schools and Communities Act amendments of 1989 (Public Law 101-226) requires federal contractors and grantees to certify that they will provide a drug-free school. As a recipient of federal grants, the District must adopt a program toward accomplishing this goal. While federal legislation has been the impetus for creation of the program, the administration and Governing Board recognize that substance abuse is a problem of national proportions that also affect students at Maricopa Community Colleges. Based upon that concern, it is intended that this program on prevention of alcohol and drug abuse on college campuses will go beyond the strict dictates of the law and will serve as a comprehensive educational and resource tool.

The Maricopa Community Colleges are committed to maintaining learning environments that enhance the full benefits of a student's educational experience. The Maricopa Community College District will make every effort to provide students with optimal conditions for learning that are free of the problems associated with the unauthorized use and abuse of alcohol and drugs. Part of the educational mission of Maricopa Community Colleges, in conjunction with this program, is to educate students about positive self-development, the benefits of a healthy lifestyle and the health risks associated with substance abuse.

The purpose of this program is to:

- a. Ensure that the Maricopa Community Colleges working and learning environment for students and the public is safe, orderly and free of illegal activity.
- b. Comply with the Drug-Free School and Communities Act of 1989, and other relevant substance abuse laws.
- c. Provide students with access to appropriate treatment and rehabilitation assistance for problems associated with substance use or abuse.

2. Standards of Conduct

In the student handbooks of the Maricopa Community Colleges under codes of conduct, the following are examples of behavior that is prohibited by law and/or college rules and policies:

- a. Drinking or possession of alcoholic beverages on the college campus.
- b. Misuse of narcotics or drugs.

3. Sanctions for Violation of Standards of Conduct

Disciplinary actions include, but are not limited to:

- a. Warning,
- b. Loss of privileges,
- c. Suspension, or
- d. Expulsion.

Continued next page...

Student Rights and Responsibilities

4. Legal Consequences of Alcohol and Other Drugs

a. Laws Governing Alcohol

The State of Arizona sets twenty-one as the legal drinking age. An underage person who buys, receives, possesses or consumes alcoholic beverages is guilty of a misdemeanor and may be subject to a fine and imprisonment for up to six months.

The Uniform Act Regulating Traffic on Highways prohibits driving while under the influence of intoxicating liquor or drugs (DWI). Drivers charged with DWI who refuse to be tested face suspension of their licenses or permits to drive for twelve months. A driver whose test results show a blood or breath alcohol concentration of 0.08 or more will have his/her license or permit to drive suspended or denied for not less than ninety consecutive days. The punishment for DWI ranges from not less than twenty-four consecutive hours in jail and a fine of not less than \$250 for a first offense to a minimum of six months in jail and revocation of the driver's license for three years upon a third offense.

b. Federal Penalties and Sanctions for Illegal Possession of a Controlled Substance

First conviction: Up to one year imprisonment and fined at least \$1,000 but not more than \$100,000, or both.

After one prior drug conviction: At least fifteen days in prison, not to exceed two years and fined at least \$2,500 but not more than \$250,000, or both.

After two or more prior drug convictions: At least ninety days in prison, not to exceed three years and fined at least \$5,000 but not more than \$250,000, or both.

Special sentencing provisions for possession of crack cocaine: Mandatory at least five years in prison, not to exceed twenty years and fined up to \$250,000, or both, if:

- 1) First conviction and the amount of crack possessed exceeds five grams.
- 2) Second conviction and the amount of crack possessed exceeds three grams.
- 3) Third or subsequent crack conviction and the amount of crack possessed exceeds one gram.

Forfeiture of personal and real property used to possess or to facilitate possession of a controlled substance if that offense is punishable by more than one year imprisonment. (See special sentencing provisions re: crack.)

Forfeiture of vehicles, boats, aircraft or any other conveyance used to transport or conceal a controlled substance.

Civil fine of up to \$10,000 (pending adoption of final regulations).

Denial of Federal benefits, such as student loans, grants, contracts, and professional and commercial licenses, up to one year for first offense, up to five years for second and subsequent offenses.

Ineligible to receive or purchase a firearm.

Miscellaneous: Revocation of certain Federal licenses and benefits, e.g. pilot licenses, public housing tenancy, etc., are vested within the authorities of individual Federal agencies.

Note: These are only Federal penalties and sanctions.

c. State Penalties and Sanctions

Title Thirteen, Chapter 34 of the Arizona Revised Statutes, lists drug offenses and their penalties. Following is a list of drugs that are frequently misused with a description of the potential penalties attached to a conviction.

- 1) Marijuana: A first offense for possession or use of marijuana in an amount of less than one pound constitutes a class 6 felony and carries a possible prison term of one and one-half years and a fine of not less than seven hundred fifty dollars. The sale of marijuana in an amount of less than one pound carries a prison sentence of four years and a fine of at least seven hundred fifty dollars.
- 2) LSD: Possession, use and sale of LSD are felonies carrying sentences from four to five years and fines of not less than one thousand dollars.
- 3) Heroin and Cocaine: Possession, use and sale of heroin are felonies carrying sentences from four to seven years and a fine of not less than two thousand dollars.

C. Alcoholic Beverages - Usage Regulation (AR 4.13)

1. No alcoholic beverage is allowed on or in the premises owned (by the State) and/or leased/rented by the Maricopa Community Colleges for District-approved educational purposes, except as provided herein.
2. No purchase of alcoholic beverages is allowed from any funds under the jurisdiction of the Governing Board of the District.
3. Lawful occupants of residential housing under the jurisdiction of the Governing Board, if over the age of 21 years and not otherwise lawfully barred from such practice, may possess and consume alcoholic beverages in the privacy of their respective leased housing facility. Guests of such occupants over the age of 21 years shall have the same privilege. No alcohol is permitted in public areas (nor common areas of a dormitory) at any time.
4. The personal or individual purchase of alcoholic beverages by individuals attending District-approved functions held in places serving alcoholic beverages is a personal and individual responsibility. Administrative discretion shall be exercised in the approval of the location of such activities, as such decision pertains to the nature of the group involved.

D. Other Health Concerns

General Guidelines Concerning AIDS

Neither a diagnosis of AIDS nor a positive HIV antibody test will be part of the initial admission decision for those applying to attend any of the Maricopa Community Colleges. The Maricopa Community Colleges will not require screening of students for antibody to HIV.

Students with AIDS or a positive HIV antibody test will not be restricted from access to student unions, theaters, cafeterias, snack bars, gymnasiums, swimming pools, recreational facilities, restrooms, or other common areas, as there is not current medical justification for doing so.

Where academically and logistically feasible, students who have medical conditions, including AIDS, may seek accommodation in order to remain enrolled. Medical documentation will be needed to support requests for accommodation through the Office of Disabled Resources and Services or the Office of Vice President of Student Affairs.

Student Rights and Responsibilities

The Maricopa Community Colleges acknowledge the importance of privacy considerations with regard to persons with AIDS. The number of people who are aware of the existence and/or identity of students who have AIDS or a positive HIV antibody test should be kept to a minimum. When a student confides in a faculty member, knowledge of the condition should be transmitted to the appropriate vice president or designee who will make the determination if the information should be further disseminated. It should be remembered that mere exposure to the person in a classroom does not constitute a need to know the diagnosis. It is, therefore, unnecessary to document in a student's file the fact that he or she has AIDS unless the information is to be used for accommodation reasons. Sharing confidential information without consent may create legal liability.

Students are encouraged to contact the Office of Disabled Resources and Services and/or the vice president of student affairs or designee for the types of services available in the district or community on matters regarding AIDS or the HIV virus.

Disability Resources & Services Eligibility for Accommodations and Required Disability Documentation (AR 2.8)

The purpose of this policy is to specify the disability documentation requirements that will qualify (i.e., support current and essential needs) Maricopa County Community College District students for reasonable and appropriate accommodations through each college's disability services office or designated professional. This regulation is implemented in accordance with the American's with Disabilities Act.

General Eligibility Requirements

Each applicant with a disability must meet MCCCDC admissions requirements, or be enrolled as an MCCCDC student, and must provide disability resource services (DRS) with required documentation verifying the nature and extent of the disability prior to receiving any accommodation. The disability services office coordinator/program advisor is responsible for evaluating documentation and determining accommodation eligibility.

Specific Eligibility Requirements Physical Disabilities - Required Documentation

The student must submit a written, current diagnostic report of any physical disabilities that are based on appropriate diagnostic evaluations administered by trained and qualified (i.e., certified and/or licensed) professionals (e.g., medical doctors, ophthalmologists, neuropsychologists, audiologists). Disability diagnosis categories include:

1. Orthopedic disability
2. Blind or visual impairment
3. Deaf or hard-of-hearing
4. Traumatic brain injury
5. Other health-related/systemic disabilities

The Written Diagnostic Report Must Include:

- a) A clear disability diagnosis, including a clinical history that establishes the date of diagnosis, last contact with the student, and any secondary conditions that might be present.
- b) The procedures used to diagnose the disability.
- c) A description of any medical and/or behavioral symptoms associated with the disability.

- d) A discussion of medications, dosage, frequency, and any adverse side effects attributable to their use that the student has experienced.
- e) A clear statement specifying functional manifestations (i.e., substantial limitations to one or more major life activities and degree of severity) due to the disability and/or medications for which the student may require accommodations.
- f) A recommendation for accommodation, including rationale. If the accommodation recommendations are specific to limitations in learning (e.g., reading, mathematics, written expression), an appropriate psycho-educational or neuropsychological evaluation must be administered to document ability/achievement discrepancies.

Specific Learning Disabilities - Required Documentation

The student shall submit a written diagnostic report of specific learning disabilities that is based on current appropriate, comprehensive, psycho-educational evaluations using adult normed instruments.

The assessment or evaluation which leads to the diagnosis must be administered by a trained and qualified (i.e., certified and/or licensed) professional (e.g., psychologist, school psychologist, neuropsychologist, or educational diagnostician) who has had direct experience with adolescents and adults with learning disabilities.

An Appropriate Psycho Educational Evaluation Must Include Comprehensive Measures in Each of the Following Areas:

1. Aptitude (the evaluation must contain a complete intellectual assessment, with all sub-tests and standard scores reported).
2. Academic achievement (the evaluation must contain a comprehensive achievement battery with all sub-tests and standard scores reported) the test battery should include current levels of functioning in the relevant areas, such as reading (decoding and comprehension), mathematics, and oral and written expression.
3. Information processing (the evaluation should assess specific information processing areas such as short- and long-term memory, sequential memory, auditory and visual perception/processing, processing speed, executive function, and motor ability).

Examples of Measures

- a) Wechsler Adult Intelligence Scale - Revised (WAIS-R)
- b) Wechsler Adult Intelligence Scale - Third Edition
- c) Stanford Binet Intelligence Scale - Fourth Edition
- d) Woodcock-Johnson Psycho-Educational Battery - Revised: Tests of Cognitive Ability
- e) Kaufman Adolescent and Adult Intelligence Test

Achievement

- a) Wechsler Individual Achievement Tests (WIAT)
- b) Woodcock-Johnson Psycho-Educational Battery - Revised: Tests of Achievement (W-Jr)
- c) Stanford Test of Academic Skills (TASK)
- d) Scholastic Abilities Test for Adults (SATA)

Information Processing

- a) Subtests of the WAIS-R or WAIS - Third Edition
- b) Subtests on the Woodcock-Johnson Psycho-Educational Battery - Revised: Tests of Cognitive Ability

Continued next page...

Student Rights and Responsibilities

Diagnostic Report

The diagnostic report must include the following information:

1. A diagnostic interview that addresses relevant historical information, past and current academic achievement, instructional foundation, past performance in areas of difficulty, age at initial diagnosis, and history of accommodations used in past educational settings and their effectiveness.
2. A list of all instruments used in the test battery.
3. Discussion of test behavior and specific test results.
4. A diagnostic summary statement with the following information:
 - a) A clear and direct statement that a learning disability does or does not exist, including a rule-out of alternative explanations for the learning problems. Terms such as *appears*, *suggests*, or *probable* used in the diagnostic summary statement do not support a conclusive diagnosis.
 - b) A clear statement specifying the substantial limitations to one or more major life activities.
 - c) A psychometric summary of scores.
 - d) A recommendation for accommodations, including rationale.

Diagnosis of specific learning disabilities that do not contain psycho-educational measures may not be used for determining eligibility for academic accommodations. For example, school plans such as individualized education plans (IEPS) or 504 plans are not adequate documentation; however, they can be included with the required evaluation. DRS reserves the right to request reassessment when questions regarding previous assessment or previous service provision arise.

Attention Deficit Hyperactivity Disorder (ADHD)/ Attention Deficit Disorder (ADD) – Required Documentation

The student shall submit a current diagnosis of attention deficit hyperactivity disorder (ADHD)/attention deficit disorder (ADD) that is based on appropriate diagnostic evaluations administered by trained and qualified (i.e., certified or licensed) professionals (e.g., psychiatrists, psychologists, or neuropsychologists).

The Diagnostic Report Must Include:

1. A diagnostic interview addressing relevant historical information, past and current academic achievement, age at initial diagnosis, discussion of medication, and history and effectiveness of accommodations in past educational settings.
2. The procedures used to diagnose the disability (including a list of all instruments used in the assessment).
3. Discussion of the testing results and behavior, including the symptoms that meet the criteria diagnosis. If the student was evaluated while on medication, the effect this may have had on performance must be noted.
4. DSM-IV diagnosis (including all five axes)
5. A diagnostic summary statement that includes the following information:
 - a) A clear statement that ADHD/ADD does or does not exist, including a rule-out of alternative explanations for behaviors. Terms such as *appears*, *suggests*, or *has problems with* used in the diagnostic summary statement do not support a conclusive diagnosis.

- b) A clear statement specifying the substantial limitations to one or more major life activities and the degree of severity. If the limitations are in learning (e.g., reading, mathematics, and written expression), an appropriate psycho-educational evaluation must be administered to document ability/achievement discrepancies.
- c) A recommendation regarding medications or medical evaluation(s).
- d) A recommendation for accommodations, including rationale.

Psychological Disabilities – Required Documentation

If the diagnostic report is more than one year old, a letter from a qualified professional that provides an update of the diagnosis with a description of the individual's current level of functioning during the past year, and a rationale for the requested accommodations must be submitted.

The Diagnostic Report Must Include the Following:

1. A clinical interview, relevant historical information, age at initial diagnosis, duration and severity of the disorder.
2. Discussion of medications review of past and current academic achievement, and history of disability accommodations and their effectiveness.
3. The procedures used to diagnose the disability (include a list of all instruments used in the assessment and test scores as applicable).
4. Discussion of the assessment results.
5. DSM-IV diagnosis (include all five axes)
6. A diagnostic summary statement that includes the following:
 - a) A clear statement that a disability does or does not exist. Terms such as *appears*, *probable*, and *suggests* used in the diagnostic summary statement do not support a conclusive diagnosis.
 - b) A clear statement specifying the substantial limitations to one or more major life activities. If the limitations are in learning (e.g., reading, mathematics, and written expression), an appropriate psycho-educational evaluation must be administered to document ability/achievement discrepancies.
 - c) A discussion of medications and their possible impact on academic functioning (e.g., concentration, attention, sedation).
 - d) A recommendation for essential accommodations relative to the diagnosed disability, including rationale.
 - e) The duration for which these accommodations should be provided based on the current assessment.
 - f) A recommendation regarding reevaluation to determine ongoing need for disability accommodations (e.g., one semester, one year, two years).

Temporary Impairments

Some disabilities are temporary and may require accommodations for a limited time. Each case is considered individually. The following documentation is required:

1. Written correspondence on letterhead from a qualified professional stating diagnosis, functional limitations necessitating the accommodation, and the estimated length of time services will be needed.
2. Services may be provided for ten (10) working days pending receipt of documentation. If documentation is not received by that time, services will be canceled.

Student Rights and Responsibilities

Special Considerations

A requirement for documentation prescribed in this regulation may be considered at the discretion of each college's disability services office or designated professional if, in the professional opinion of the responsible college's disability services office or designated professional, such consideration is in the best interest of the student and will neither undermine the integrity of any college offering nor violate any mandate under state or federal law. All situations shall be considered on an individual, case-by-case basis. Reasonable accommodation is required for students with known disabilities. MCCCDC will make every attempt to provide preferred accommodations, however, the most effective and reasonable accommodation may be determined to meet sufficient accessibility needs.

Academic Misconduct (AR 2.3.11)

A. Definitions

1. **Academic Misconduct** – includes misconduct associated with the classroom, laboratory or clinical learning process. Some examples of academic misconduct are cheating, plagiarism and excessive absences.
2. **Cheating** – includes but is not limited to, (a) use of any unauthorized assistance in taking quizzes, tests, assessment tests or examinations; (b) dependence upon the aid of sources beyond those authorized by the faculty member in writing papers, preparing reports, solving problems or carrying out other assignments; or (c) the acquisition, without permission, of tests or other academic material belonging to a member of the college faculty or staff.
3. **Plagiarism** – includes, but is not limited to, the use of paraphrase or direct quotation of the published or unpublished work of another person without full and clear acknowledgment. It also includes the unacknowledged use of materials prepared by another person or agency engaged in the selling of term papers or other academic materials. Information gathered from the internet and not properly identified is also considered plagiarism.

B. Sanctions

Any student found by a faculty member to have committed academic misconduct may be subject to the following sanctions. (Note: Sanctions 1, 2, 3, and 4 may be imposed by a faculty member. The faculty member may recommend to the department chairperson and the vice president of academic affairs or designee that sanctions 5, 6, or 7 be imposed. College suspension or expulsion will be imposed only by the vice president of academic affairs or designee.

1. **Warning** – A notice in writing to the student that the student has violated the academic code.
2. **Grade Adjustment** – Lowering of a score on a test or assignment.
3. **Discretionary Sanctions** – Additional academic assignments determined by the faculty member.
4. **Course Failure** – Failure of a student in the course where academic misconduct occurs.
5. **Disciplinary Probation** – Disciplinary probation is for a designated period of time and includes the probability of more severe sanctions if the student commits additional acts of academic misconduct.
6. **College Suspension** – Separation of the student from the college for a definite period of time, after which the student is eligible to return. Conditions for readmission may be specified. (A suspension from one Maricopa Community College will apply to all other colleges/centers in the District.)

7. **College Expulsion** – Permanent separation of the student from the college. (Expulsion from one Maricopa Community College will apply to all colleges/centers in the District.)

C. Appeal of Sanctions for Academic Misconduct

Students can appeal sanctions imposed for academic misconduct by following the instructional grievance process (AR 2.3.5).

Disciplinary Standards

A. Disciplinary Probation and Suspension (AR 2.5.1)

According to the laws of the State of Arizona, jurisdiction and control over the Maricopa Community Colleges are vested in the District Governing Board. The Governing Board and its agents—the chancellor, administration and faculty—are granted broad legal authority to regulate student life subject to basic standards of reasonableness.

In developing responsible student conduct, the Maricopa Community Colleges prefer mediation, guidance, admonition and example. However, when these means fail to resolve problems of student conduct and responsibility, appropriate disciplinary procedures will be followed.

Misconduct for which students are subject to disciplinary action falls into the general areas of:

1. Cheating on an examination, assessment tests, laboratory work, written work (plagiarism), falsifying, forging or altering college records.
2. Actions or verbal statements which threaten the personal safety of any faculty, staff, students or others lawfully assembled on the campus, or any conduct which is harmful, obstructive, disruptive to, or interferes with the educational process or institutional functions.
3. Violation of Arizona statutes and/or college regulations and policies.
4. Use of college computer resources such as the Internet in violation of Technology Resource Standards (AR 4.4), which may result in notification of law enforcement authorities.

B. Disciplinary Removal from Class

A faculty member may remove a student from class meetings for disciplinary reasons. If a faculty member removes a student for more than one class period, the faculty member shall notify the department/division chair and the appropriate vice president or designee in writing of the problem, action taken by the faculty member, and the faculty member's recommendation. If a resolution of the problem is not reached between the faculty member and the student, the student may be removed permanently pursuant to due process procedures.

Student Rights and Responsibilities

Student Disciplinary Code (AR 2.5.2)

The purpose of this policy is to help ensure a healthy, comfortable and educationally productive environment for students, employees and visitors.

Article I: Definitions

The following are definitions of terms or phrases contained within this document:

- A. College means Maricopa Community Colleges or designated college or center. College president also refers to center provost.
- B. Student means any person taking courses at the college whether full-time and part-time. Persons who are not officially enrolled for a particular term but who have a continuing relationship with the college are considered students.
- C. Faculty member means any person hired by the college or District to conduct classroom instruction.
- D. College official means any person employed by the college or district, performing assigned administrative or professional responsibilities pursuant to this Student Code. The college president/provost shall designate the college official to be responsible for the administration of this Student Code.
- E. College community means students, faculty members, college officials or any other persons employed by the college. A person's status in a particular situation shall be determined by the college president/provost.
- F. College premises means all land, buildings, facilities, and other property in the possession of or owned, used or controlled by the college or District.
- G. Organization means a group that has complied with the formal requirements for college recognition.
- H. Judicial body means any person or persons authorized by the college president to determine whether a student has violated the Student Code and to recommend imposition of sanctions.
- I. Judicial advisor means a college official authorized on a case-by-case basis by the college president/provost to impose sanctions upon students found to have violated this Student Code. The college president/provost may authorize a judicial advisor to serve simultaneously as a judicial advisor and the sole member or one of the members of a judicial body. Nothing shall prevent the college president/provost from authorizing the same judicial advisor to impose sanctions in all cases.
- J. Appellate boards means any person or persons authorized by the college president/provost to consider an appeal from a judicial body's determination that a student has violated this Student Code or from the sanctions imposed by the judicial advisor. Nothing shall prevent the college president/provost from acting as the appellate board.
- K. The term shall is used in the imperative sense.
- L. The term may is used in the permissive sense.
- M. The term policy is defined as the written regulations of the college and/or District as found in, but not limited to, this Student Code and Governing Board policy.

Article II: Judicial Authority

- A. The college president/provost shall determine the composition of judicial bodies and appellate boards and determine which judicial advisor, judicial body and appellate board shall be authorized to hear each case.
- B. The judicial advisor shall develop procedures for the administration of the judicial program and rules for the conduct of hearings that are consistent with provisions of this Student Code.
- C. Decisions made by the judicial advisor shall be final, pending the normal appeal process.

Article III: Prescribed Conduct

A. Jurisdiction of the College

Generally college jurisdiction and discipline shall be limited to conduct which occurs on college/center premises and/or during college sponsored or supervised activities, or which adversely affects the college community and/or pursuit of its objectives.

B. Conduct - Rules and Regulations

Any student found to have committed the following misconduct is subject to the disciplinary sanctions outlined in Article IV:

1. Acts of dishonesty, including but not limited to the following:
 - a. Furnishing false information to any official, college employee or office.
 - b. Forgery, alteration, or misuse of any college document, record or instrument of identification.
 - c. Tampering with the election of any college-recognized student organization.
2. Disruption or obstruction of teaching, research, administration, disciplinary proceedings or college activities, including its public service functions on or off campus, or other authorized non-college activities, when the act occurs on college premises.

A faculty member may remove a student from a class meeting for disciplinary reasons. If a faculty member removes a student for more than one class period, the faculty member shall notify the appropriate vice president or designee in writing of the problem, action taken by the faculty member, and the faculty member's recommendation. If a resolution of the problem is not reached, the student may be removed permanently pursuant to the appropriate due process procedures.
3. Physical abuse, verbal abuse, threats, intimidation, harassment, coercion and/or conduct which threatens or endangers the health or safety of any person.
4. Attempted or actual theft of and/or damage to property of the college or property of a member of the college community or other personal or public property.
5. Failure to comply with direction of college officials or law enforcement officers in the performance of their duties and/or failure to identify one's self to these persons when requested to do so.
6. Unauthorized possession, duplication or use of keys to any college premises, or unauthorized entry to or use of college premises.
7. Violation of published Governing Board policy, college rules or regulations.

Student Rights and Responsibilities

8. Violation of federal, state, or local law on college/center premises or at college-sponsored or supervised activities.
9. Use, possession or distribution of narcotic or other controlled substances, except as expressly permitted by law.
10. Use, possession or distribution of alcoholic beverages or public intoxication.
11. Illegal or unauthorized possession of firearms, explosives, other weapons, or dangerous chemicals on college premises.
12. Participation in a college demonstration that disrupts the normal operations of the college and infringes on the rights of other members of the college community; leading or inciting others to disrupt scheduled and/or normal activities within any college building or area; intentional obstruction which unreasonably interferes with freedom of movement, either pedestrian or vehicular, on campus.
13. Obstruction of the free flow of pedestrian or vehicular traffic on college premises or at college-sponsored or supervised activities.
14. Conduct which is disorderly, lewd or indecent; breach of the peace; or aiding, abetting or procuring another person to breach the peace on college premises or at activities sponsored by or participated in by the college.
15. Attempted or actual theft or other abuse of computer time, including but not limited to:
 - a. Unauthorized entry into a file to use, read or change the contents or for any other purpose.
 - b. Unauthorized transfer of a file.
 - c. Unauthorized use of another user's identification and password.
 - d. Use of computing facilities to interfere with the work of another student, faculty member or college official.
 - e. Use of computing facilities to send obscene or abusive messages.
 - f. Use of computing facilities to interfere with normal operation of the college computing system.
 - g. Use of computing facilities for students' personal benefit.
16. Abuse of the judicial system, including but not limited to:
 - a. Falsification, distortion or misrepresentation of information before a judicial body.
 - b. Disruption or interference with judicial proceedings.
 - c. Institution of a judicial proceeding knowingly without cause.
 - d. Attempting to discourage an individual's proper participation in, or use of, the judicial system.
 - e. Attempting to influence the impartiality of the member of a judicial body prior to, and/or during the course of, the judicial proceeding.
 - f. Harassment, either verbal or physical, and/or intimidation of a member of a judicial body prior to, during and/or after a judicial proceeding.
 - g. Failure to comply with the sanctions imposed under this Student Code.
 - h. Influence or attempting to influence another person to commit an abuse of the judicial system.

C. Violation of Law and College Discipline

1. When a student is charged only with an off-campus violation of federal, state, or local laws but not with any other violation of this Student Code, disciplinary action may be taken and sanctions imposed for grave misconduct that demonstrates flagrant disregard

for the college community. In such cases, no sanction may be imposed unless the student has been found guilty in a court of law or has declined to confess such charges, although not actually admitting guilt, e.g., no contest or nolo contendere.

2. College disciplinary proceedings may be instituted against a student charged with violation of a law which is also a violation of this Student Code, for example, if both violations result from the same factual situation, without regard to the pendency to civil litigation in court or criminal arrest and prosecution. Proceedings under this Student Code may be carried out before, during, or after civil or criminal proceedings off campus.
3. When a student is charged by federal, state or local authorities with a violation of law, the college will not request or agree to special considerations for that individual because of his or her status as a student. If the alleged offense is also a subject of a proceeding before a judicial body under this Student Code, however, the college may advise off-campus authorities of the existence of this Student Code and of how such matters will be handled internally within the college community. The college will cooperate fully with the law enforcement and other agencies in the enforcement of criminal law on campus and in the conditions imposed by criminal courts for the rehabilitation of student violators. Individual students and faculty members, acting within their personnel capacities, remain free to interact with governmental representatives as they deem appropriate.

Article IV: Judicial Policies

A. Charges and Hearings

1. Any member of the college community may file charges against any student for his or her conduct under this Student Code. Charges shall be prepared in writing and directed to the judicial advisor responsible for administration of the college judicial system. Any charge should be submitted within thirty (30) days of the incident. The judicial advisor will rule on the timeliness of the charges.
2. The judicial advisor may conduct an investigation to determine if the charges have merit and/or if they can be disposed of administratively by mutual consent of the parties involved on a basis acceptable to the judicial advisor. Such dispositions shall be final and there shall be no subsequent proceedings. If the charges cannot be disposed of by mutual consent, the judicial advisor may later serve in the same matter as the judicial body or a member thereof.
3. All charges shall be presented to the accused student in written form. A time shall be set for a hearing, not less than five (5) nor more than fifteen (15) working days after the student has been notified. Maximum time limits for scheduling of hearings may be extended at the discretion of the judicial advisor.
4. Hearings shall be conducted by judicial body according to the following guidelines:
 - a. Hearings normally shall be conducted in private.
 - b. Admission of any person to the closed hearing shall be at the discretion of the judicial body, and/or its judicial advisor.
 - c. In hearings involving more than one accused student, the chairperson of the judicial body, in his or her discretion, may permit the hearing concerning each student to be conducted separately.

Continued next page...

Student Rights and Responsibilities

- d. The complainant and the accused shall have the right to be assisted by any advisor they choose, at their own expense. The advisor may be an attorney. Both the complainant and the accused are responsible for presenting their own cases and, therefore, advisors are not permitted to speak or participate directly in any hearing before a judicial body.
 - e. The complainant, the accused, and the judicial body shall have the privilege of presenting witnesses, subject to the right of cross-examination.
 - f. Pertinent records, exhibits, and written statements may be accepted as evidence for consideration by a judicial body at the discretion of the chairperson.
 - g. All procedural questions are subject to the final decision of the chairperson of the judicial body.
 - h. After the hearing, the judicial body (if consisting of multiple members) shall determine by majority vote whether the student violated the designated sections of this Student Code. The judicial body shall render written findings of fact and conclusions and forward these along with recommended sanctions as outlined in Article IV, Section B, to the judicial advisor within three (3) working days of the conclusion of the hearing.
 - i. The judicial body's determination shall be made on the basis of whether it is more likely than not that the accused student violated this Student Code.
5. There shall be a single verbatim record, such as a tape recording, of all hearings before the judicial body. The record shall be the property of the college and/or District.
 6. No student may be found to have violated this Student Code solely because the student failed to appear before a judicial body. In all cases, the evidence and support of the charges shall be presented and considered.

B. Sanctions

1. The following sanctions may be imposed upon any student found to have violated the Student Code:
 - a. **Warning** - a written notice to the student that the student is violating or has violated institutional regulations.
 - b. **Probation** - a written reprimand for violation of specified regulations. Probation is for a designated period of time and includes the probability of more severe disciplinary sanctions if the student is found to be violating any institutional regulation(s) during the probationary period.
 - c. **Loss of Privileges** - denial of specified privileges for a designated period of time.
 - d. **Restitution** - compensation for loss, damage or injury.
 - e. **Discretionary Sanctions** - work assignments, service to the college, or other related discretionary assignments. (Such assignments must have the prior approval of the judicial advisor.)
 - f. **College Suspension** - separation of the student from the college for a definite period of time, after which the student is eligible to return. Conditions for readmission may be specified. (College suspension applies at all of the Maricopa Community Colleges.)
 - g. **College Expulsion** - permanent separation of the student from the college. (College expulsion applies at all of the Maricopa Community Colleges.)
2. More than one of the sanctions listed above may be imposed for any single violation.

3. Other than college expulsion, disciplinary sanction shall not be made part of the student's academic record, but shall become part of the student's confidential record. Upon graduation, the student's confidential record may be expunged of disciplinary actions upon the student's application to the judicial advisor. Cases involving the imposition of sanctions other than suspension or expulsion shall be expunged from the student's confidential record five (5) years after final disposition of the case.
4. The following sanctions may be imposed upon groups or organizations:
 - a. Those sanctions listed above in Section B, paragraphs 1.a through d.
 - b. Deactivation - loss of all privileges, including college recognition for a designated period of time.
5. All sanction(s) shall be determined and imposed by the judicial advisor based upon the findings and conclusions of the judicial body. The judicial advisor will consider the recommendations for sanction(s) of the judicial body but will not be bound by its recommendations. The judicial advisor will forward the sanctions s/he determines to be appropriate along with the findings and conclusion to the accused student within two (2) working days after receipt of the judicial body's findings.

C. Interim Suspension

In certain circumstances, college/center officials may impose an interim suspension prior to the hearing before a judicial body.

1. Interim suspension may be imposed only:
 - a. To insure the safety and well-being of members of the college community or preservation of college property;
 - b. To insure the student's own physical or emotional safety and well-being; or
 - c. If the student poses a definite threat of disruption of or interference with the normal operations of the college.
2. During the interim suspension, the student shall be denied access to the college including classes and/or all other activities or privileges for which the student might otherwise be eligible, as the judicial advisor deems appropriate.

D. Appeals

1. A decision reached by the judicial body or a sanction imposed by the judicial advisor may be appealed by accused students or complainants to an appeal board within five (5) working days of receipt of the decision. Such appeals shall be in writing and shall be delivered to the judicial advisor or his/her designee.
2. An appeal shall be limited to the review of the verbatim record of the initial hearing and supporting documents for one or more of the following purposes:
 - a. To determine whether the original hearing was conducted fairly and in accordance with this Student Code's prescribed procedures.
 - b. To determine whether the decision reached regarding the accused student was in conformance with the standard established in Article IV, section A, paragraph 4(i).
 - c. To determine whether the sanction(s) imposed was appropriate to the violation.
 - d. To consider new evidence.

Student Rights and Responsibilities

3. If an appeal is upheld by the appellate board, the matter shall be remanded to the original judicial body and judicial advisor for reopening of the hearing to allow consideration of the original determination and/or sanction(s).

In cases involving appeals by students accused of violating this Student Code, review of the sanction by the appellate board may not result in more severe sanction(s) for the accused student. Instead, following an appeal, the appropriate college official may, upon review of the case, reduce but not increase the sanctions imposed by the judicial advisor.

4. In cases involving appeals by persons other than students accused of violating this Student Code, the appropriate college official may, upon review of the case, reduce or increase the sanctions imposed by the judicial advisor or remand the case to the original judicial body and judicial advisor.

Article V: Interpretation and Revision

- A. Any question of interpretation regarding this Student Code shall be referred to person designated in Article I, paragraph D, or his/her designee, for final determination.
- B. The Student Code shall be reviewed every three (3) years under the direction of the Vice-Chancellor for Student and Community Affairs.

Student Records (AR 2.5.3)

A. Definitions

For the purposes of this policy, the Maricopa County Community College District has used the following definition of terms.

1. College – includes all colleges, educational centers, skill centers and district office.
2. Educational Records – any record (in handwriting, print, tapes, film, or other media) maintained by the college or an agent of the college which is directly related to a student, except:
 - a. A personal record kept by a staff member, if it is kept in the personal possession of the individual who made the record, and information contained in the record has never been revealed or made available to any other person except the maker's temporary substitute.
 - b. An employment record of an individual whose employment is not contingent on the fact that s/he is a student, provided the record is used only in relation to the individual's employment.
 - c. Records maintained by the college's security unit, if the record is maintained solely for law enforcement purposes, is revealed only to law enforcement agencies of the same jurisdiction and the security unit does not have access to education records maintained by the community college.
 - d. Alumni records which contain information about a student after he or she is no longer an attendant of the community college and the records do not relate to the person as a student.

B. Annual Notification

Students will be notified of their further rights annually by publication in the college catalog and/or the student handbook:

Rights of Access to Educational Records

The Family Educational Rights and Privacy Act (FERPA) affords students certain rights with respect to their education records. These rights are:

1. The right to inspect and review the student's education records within 45 days of the day the college receives a request for access.

Students should submit to the college admissions and records department written requests that identify the record(s) they wish to inspect. The college official will make arrangements for access and notify the student of the time and place where the records may be inspected. If the records are not maintained by the college official to whom the request was submitted, that official shall advise the student of the correct official to whom the request should be addressed.

2. The right to request the amendment of the student's education records that the student believes to be inaccurate or misleading.

Students may ask the college to amend a record that they believe is inaccurate or misleading. They should write the college official responsible for the record, clearly identify the part of the record they want changed, and specify why it is inaccurate or misleading.

If the college decides not to amend the record as requested by the student, the college will notify the student of the decision and advise the student of his or her right to a hearing regarding the request for amendment. Additional information regarding the hearing procedures will be provided to the student when notified of the right to a hearing.

3. The right to consent to disclosures of personally identifiable information contained in the student's education records, except to the extent that FERPA authorizes disclosure without consent.

One exception, which permits disclosure without consent, is disclosure to school officials with legitimate educational interests. A school official is defined as a person employed by the college or District in an administrative, supervisory, academic, or support staff position (including law enforcement unit and health staff); a person or company with whom the college or District has contracted (such as an attorney, auditor, or collection agent); a person serving on the Governing Board; or a person assisting another school official in performing his or her tasks.

A school official has a legitimate educational interest if the official needs to review an education record in order to fulfill his or her professional responsibility.

Upon request, the college discloses education records without consent to officials of another school in which a student seeks or intends to enroll.

4. The right to file a complaint with the U.S. Department of Education concerning alleged failures by the college to comply with the requirements of FERPA.

The name and address of the Office that administers FERPA is:

Family Policy Compliance Office
U.S. Department of Education
400 Maryland Avenue, S.W.
Washington, DC 20202-4605

Continued next page...

Student Rights and Responsibilities

C. Student Directory

A Maricopa community college may release directory information about any student who has not specifically requested the withholding of such information. Students who do not want directory information released may so indicate during the admissions process or notify the Office of Admissions and Records.

At any Maricopa community college, directory information is defined as a student's name, address, telephone number, major field of study, participation in officially recognized activities and sports, weight and height of members of athletic teams, degrees and awards received, dates of attendance, part-time or full-time status, most recent previous educational agency or institution attended by the student, college within the Maricopa Community Colleges where the student has been enrolled, photograph of student, and electronic mail address.

D. Use of Educational Records for Advisement Purposes

All colleges within the Maricopa Community Colleges have access to the computerized degree audit program. During the advisement process, each student may have his or her academic record reviewed for coursework taken at any of the District's colleges or centers.

The institution retains the right to exercise discretion in determining the release of directory information.

E. Disclosure to Parents

In accordance with federal law, college officials may disclose educational records to parents of minors or to parents of a student who have established the student's status as a dependent according to the Internal Revenue Code of 1986, section 152, without the written consent of the student.

Student Employment (AR 2.5.4)

A. District Student Employees

1. Introduction

Students may be employed by the college as student help. District regulations require that students be hired in essential jobs and that they be properly trained and supervised.

2. Philosophy and Workload for Student Employees

- It shall be the philosophy of Maricopa Community College District that a student may work to augment college and living expenses; however, the scholastic endeavor should be foremost. Sufficient time should be allotted for classroom attendance, homework, out-of-class study, and participation in activities.
- A workload of twenty (20) hours per week should be established as the maximum number of hours a student employee may work on campus. All student employees shall be enrolled in a minimum of three (3) semester credit hours. Any combination of day and evening hours would meet this requirement. Any student employee having special reasons to work over 20 hours per week or having dropped below three (3) credit hours should request his/her immediate supervisor to obtain approval from the college president or his/her designee.
- During the summer sessions, students may be eligible for employment if they were enrolled for a minimum of three (3) semester credit hours at the end of the spring semester, or if they have been accepted for admission for the fall semester. Exceptions to the three (3) semester credit hours may be made

by the college president, or his/her designee. Summer shall be designated as the time from the official end of the spring semester to the beginning of classes for the fall semester.

3. Student Employee Benefits

As student employees, there are no entitlements to employee benefits; i.e., vacation, retirement, sick leave, health and life, or disability insurance. Students will, however, be covered under Worker's Compensation Insurance.

4. Student Employment Records

Student employee records will be maintained at the Financial Aid office, the office of the fiscal agent or the Career/Placement Office and will be reviewed periodically by the vice president of student affairs.

5. Student Compensation

The hourly rate of pay for student employees shall coincide with the policies of the District Salary Schedule.

6. Employee Contracts and Forms (Appendix N)

- Each student seeking employment shall contact the placement office and fill out the student employment placement form. The immediate supervisor requesting student help shall fill in the hours to be worked and outline the specific duties and requirements for the position.
- Each student employee shall be required to sign an agreement form furnished by the Financial Aid office. This form is entitled Office of Financial Aid and Placement Agreement and shall be signed by the department head and the immediate supervisor.
- After the Placement Order Form and the contract (agreement form) have been signed, the student and immediate supervisor are responsible for properly signing and submitting time cards. When changes in work schedules are necessary or a student is transferred or terminated, the immediate supervisor will contact the Financial Aid office and complete the necessary paperwork for the changes.

7. Student Employee Grievance Procedure

Part-time student employees working for one of the Maricopa Community Colleges may wish to file a grievance relating to certain working conditions or violation of student employment regulation. Please refer to the Non-Instructional Complaint Resolution Process (AR 2.3.5).

B. Student Security Guards

1. Introduction and Philosophy

Students may be employed by the college as student help. If student guards do not come from the ranks of Administration of Justice classes, they must undergo appropriate training to qualify them as student guards. This training program is outlined in the regulation.

2. Workload of Student Security Guards

- Student security guards shall be enrolled for a minimum of three (3) semester hours.
- Student security guards shall be limited to 20 hours per week when the work week starts at 7:00 a.m. on Monday and concludes at 11:00 p.m. on Friday. Additional hours may be worked if guards are assigned special duty at games or activities held on campus during the weekend, or if guards are assigned a shift on Saturday and Sunday, between 7:00 a.m. and 11:00 p.m.

Student Rights and Responsibilities

3. Students not in Administration of Justice Program

- a. Use of student other than those in Administration of Justice Program:
 - 1) Selection of the student must be personally approved by the vice president of student affairs and chief of security.
 - 2) Selection of a student should not extend beyond one semester without the approval of the vice president of student affairs.
 - 3) Selected student must undergo a special training program directed by the chief of security and approved by the vice president of student affairs.
- b. Recommended program for students other than those in Administration of Justice programs:

Students employed by campus security who are not majors in the Administration of Justice program should be given at least twenty (20) hours of training with pay before being allowed to function independently as a campus security guard. This training should include, but not be limited to, instruction in:

- 1) Wearing of the uniform, general appearance, and demeanor;
- 2) The use of the various security report forms and how to properly complete them to provide requested information; general report writing methods;
- 3) Public relations methods used on the campus;
- 4) Crime prevention methods used on the campus; patrol methods used in buildings and grounds;
- 5) Basic techniques for interviewing students, faculty and visitors relative to the incidents;
- 6) Laws and regulations governing the actions of campus security personnel concerning rendering of assistance to students, faculty and visitors on the campus.
- 7) Basic first aid.

4. Student Security Guards Employee Benefits

As student employees, there are not entitlements to employee benefits; i.e., vacation, retirement, sick leave, health and life, or disability insurance. Students will, however, be covered under Worker's Compensation Insurance.

5. Student Employment Records

The student security guard's employment records will be maintained at the office of the chief of security and reviewed periodically by the vice president of student affairs.

Student Governance (AR 2.5.5)

Student governing bodies derive their authority from the Maricopa County Community College District Governing Board that exists in accordance with Arizona Revised Statutes. The administration of the District is vested in the Chancellor who delegates responsibility for each college to the college president who serves in a management and policy implementation capacity having the ultimate responsibility for all activities of the college. The president shall designate the administrator(s) (i.e., directors of student leadership) at each college who will be charged with the responsibility for working with the college student governing body(ies) in the development of college student activities and programs.

A representative form of student governance may exist at each college/center as well as district wide to provide an effective means of communication among students, faculty, staff and administration and to provide student input in college and District matters. Eligibility requirements are to be met and spelled out in detail in each student governance constitution. These constitutions shall establish the minimum requirements for the

elective/appointive officers. All student government constitutions shall be submitted to the Governing Board legal services to ensure compliance with federal and state laws, and the Maricopa Community Colleges Governing Board Administrative Regulations. Since Rio Salado Community College is a county-wide non-campus college, the president shall ensure that opportunities exist for student involvement.

College student constitutions should be reviewed annually by student governance. The appropriate vice president or designee of each college shall be responsible for submitting any changes to the president of the college for transmittal to the Governing Board legal services.

A. Officers/Members

All reference in this document to positions will designate whether the position is an officer position or a member position.

Each student governance constitution shall define which of its elected positions (maximum of five) within its structure shall be designated as officers. The persons filling those positions shall be referred to, in this document, as officers. Persons filling all other positions, elected or appointed, shall be referred to as members (excluding non-voting committee members).

All positions filled by election shall be considered as elected positions, even though the person filling the position may have been appointed to fill an unexpired term of another individual.

B. Designation

Colleges with two (2) student governments shall designate the governments as day or evening. Colleges with one (1) government shall be considered day students, for the purposes of this document.

C. Eligibility for Office

All student governance constitutions shall prescribe that all persons selected or appointed as officers shall be enrolled in and maintain a minimum of six (6) credit hours for day student governments, three (3) credit hours for evening student governments. Officers shall have and maintain a minimum cumulative grade point average of 2.50 and be in good standing (not on probation) according to the written district policy. Convicted felons shall be ineligible for office (A.R.S. §13-904). The constitution may, however, set more rigid requirements, if so desired by college student governance.

D. Tenure of Position

Tenure in any student governance position shall be determined by the respective student governance constitutions. In no case shall any student be allowed to serve in any combination of officer/member positions beyond a total of ten (10) semesters. Tenure in any combination of officer positions shall be limited to four (4) semesters.

E. Removal from Office

Provisions shall be made in all student governance constitutions for removal for cause of individuals from elected or appointed student governance positions.

Continued next page...

Student Rights and Responsibilities

F. Remuneration Limitations

1. Student body officers may receive financial support and/or a letter grade in a leadership class during their terms of office as authorized in their respective student governance constitutions.

Student body officers (maximum of five) may receive up to twenty (20) hours per week in financial support and/or up to six (6) credit hours in leadership classes per semester. Remuneration shall be for services rendered and not for merely holding the office.

2. For qualifying students, College Work Study (CWS) funds may be used in accordance with Federal guidelines.
3. The allowance for awarding honorariums for scholarships for executive student officers is a maximum of \$200.00.
4. Compensation may be received for both honorariums/scholarships and college employment in the same semester.

G. Amending Student Constitutions

College student constitutions should be reviewed annually by student governance. The appropriate vice president or designee of each college shall be responsible for submitting any constitutional changes to the president of the college for transmittal to the Governing Board legal services.

H. Student Governance Advisors

College organization advisors will be provided for in each of the student governance constitutions. Such advisors shall be full-time or part-time employees of the Maricopa Community Colleges. Recommendations for appointment of an advisor may be submitted to the appropriate vice president, dean or college president. Recommendations for dismissal of an advisor with just cause may be submitted to the appropriate vice president, dean or college president.

I. Legal/Fiscal/Financial Matters

Authority and responsibility beyond the scope specifically covered in student policies, or interpretation of such matters within laws, board policies, etc., shall rest with the offices of legal services and Chancellor, respectively.

J. Final Authority

In the event of a complete breakdown of the governance body, the college president will serve as the final authority.

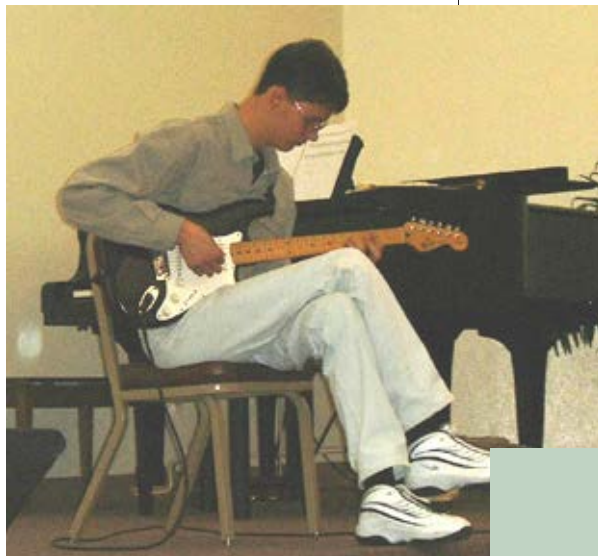

**Music
Practice Time**

ADMINISTRATION, MANAGEMENT & FACULTY



Governing Board

Dr. Donald R. Campbell	Member
Mr. Ed Contreras	Secretary
Mr. Scott Crowley	President
Mrs. Linda B. Rosenthal	Member
Mr. Jerry D. Walker	Member

Administration

DeCABOOTER, ARTHUR W.	President
A.A., St. Gregory's College, Shawnee (OK); B.A., St. John's University (MN); M.S.Ed., Ed.D., Indiana University	
NEIBLING, JOHN	Vice President Instructional Services
B.A., M.A., University of Kansas; Ed.D., Arizona State University	
STAHL, VIRGINIA	Vice President Student Affairs
B.A., Illinois State University; M.Ed., Ph.D., Arizona State University	
COUCH, CARL	Vice President Administrative Services
A.A., Scottsdale Community College; B.S., M.Ed., Arizona State University	
HERMANSON, DEAN R.	Dean of Instruction
B.S., M.S., Ed.D., University of North Dakota	
BRIMAGE, YIRA	Dean of Students
B.A., Arizona State University; M.Ed., Northern Arizona University	
GORTON, MARINA E.	Associate Dean of Instruction
B.A., California State University, Fullerton; M.A., Maxwell School, Syracuse University	
IGHODARO, OSARO O.	Associate Dean of Student Services
B.S., Northern Arizona University; M.A., Northern Arizona University; Ph.D., Northern Arizona University	

* Division Chairperson # Department Chairperson
£ Program Director

Management

BECK, STACIE	Financial Aid Assistant
A.G.S., Rio Salado College B.A., Western International University	
BRUGGMAN, CURTIS	Director, Annual Fund
B.S., Arizona State University	
BUTLER, MARK	MCTV Programming Coordinator
A.A.	
CHESROWN, CHRIS	Director, Marketing & Public Relations
B.A., Arizona State University; M.Ed., Northern Arizona University	
COCO, DARCEL	Director, Women's Athletics
B.A., Buena Vista College (IA)	
CORNELIUS, MICHAEL	Director, Advisement Services
B.A., Arizona State University; M.Ed., Northern Arizona University;	
CUDDINGTON, ANA	Coordinator, Native American Programs
B.A., Arizona State University; M.Ed., Northern Arizona University	
DANGLER, PEGGY A.	Bursar
B.A., Sienna Heights University	
DEAN, ZHARA	Director, Continuing Education
A.A., Scottsdale Community College; B.A., M.Ed., Northern Arizona University	
DeBOER, CYNDI	Manager, Career Services
A.A., Mesa Community College; B.A.E., Arizona State University; M.Ed., Northern Arizona University	
DRAGON, CATHERINE	Coordinator, Fine Arts, Facilities & Instructional Technology
EBERHARDT, PAUL	Athletic Specialist
B.A., Winona State University (MN)	
EMANUEL, CRAIG	Director, College Safety
B.S., University of Arizona; M.A., University of Phoenix	
FONG, ELSA	Coordinator, Science Laboratory
B.S., University of California, Berkeley	
GAGNON, GRANT	Director, College Technology
HUGHES, LINDA	Institutional Research Analyst
A.A., Scottsdale Community College	
JOHNSON, KAREN	Manager, College Fiscal Services
A.A.S., Mesa Community College	
KALCICH, DEANNA	Coordinator, Learning Center
B.A., University of Tulsa	
KETTERMAN, ELIZABETH	Director, Early Outreach Programs
B.S., University of Phoenix; M.Ed., Northern Arizona University	
KIND, MATTHEW	Manager, Building Operations
LANGWORTHY, PAUL	Manager, Fitness and Wellness Center
B.S., Mankato State (MN); M.Ed., Arizona State University	
LATHAM, GERALD	Coordinator, Computer Services
B.S., Northern Arizona University	
LEACH, BEN	Supervisor, Food Services
A.A.S. in Culinary Arts, Scottsdale Community College	

Administration, Management & Faculty

LeDUC, TIMOTHY	Facilities Project Manager	TENDICK, THERESE	Director, International Education Program
LEHMAN, DONNA M.A., University of Wisconsin	Coordinator, Adult Re-Entry	B.A., University of Iowa; M.A., Arizona State University	
MAHER, CRAIG	Supervisor, Building Operations	THAXTON, JOHN	Coordinator, Senior Adult Programs
B.A., Ramapo State College; A.A.S., Rio Salado College		B.A., M.A., University of Washington	
MANNIX, REGINA	Athletic Specialist	TREDE, EREKA	Coordinator, Information Technologies
B.S., Arizona State University		A.A., Scottsdale Community College; B.S. Charter Oak State College	
MARUSHAK, REBECCA	Director, Student Life and Leadership	TRIMBLE, MARSHALL	Coordinator, Southwest Studies Program
B.A., Eastern Michigan University; M.A., University of Michigan		B.A., M.A., Arizona State University	
MAYNARD, BRENDA	Coordinator, Instructional Programs/Site Operations	VAN CLEAVE, JACK	Director, Facilities
B.S., Ferris State University; M.A., Washington University			
MCGOWAN, TERENCE	Manager, Media Services	WATKINS, FRANCESCA	Director, Admissions, Registration and Records
A.A., Mesa Community College (AZ); B.S., Arizona State University		A.G.S., Scottsdale Community College	
MEDDER, NEWTON V.	Athletic Specialist	YEAGER, EDWARD	Athletic Specialist
B.S., Arizona State University		B.S., Arizona State University; M.Ed., Northern Arizona University	
MEJIA, MARK	Athletic Specialist	YNIGUEZ, ROSANNE	Supervisor, Early Childhood Center
		B.S., Arizona State University; M.A., Northern Arizona University	
NEIGHBORS, TONY	Head Athletic Trainer	YOUNG, DONNA	Manager, Disability Resources & Services
B.S., Arizona State University		B.S., M.A., New Mexico State University	
O'BRIEN, JAMES	MCTV Production Coordinator	ZHANG, RONALD	Database Administrator
B.S., Portland State University (OR)		B.S., Nanjing Normal University (China); M.S., Ph.D., Arizona State University	
O'NEILL, COLLEEN	Project Coordinator		
A.A., Ventura College; B.S., California State University; M.Ed., Northern Arizona University			
OWEN, VICKY	Manager, College Employee Services		
A.G.S., Scottsdale Community College			
PERKINS, RANDY	Coordinator, Fire Science/EMT/Police Academy Program		
PRATT, STACY	CNUW Administrative Assistant II		
B.S., Texas Tech University			
QUINTERO, JAMES	Network Administrator		
B.S., University of Phoenix; M.Ed., Northern Arizona University			
ROMERO, STELLA	Manager, College Employee Services		
B.S., Western International University			
ROWELL, TONYA	Coordinator, Science Lab		
B.S., Northern Arizona University			
SCHILLING, RON	Coordinator, Technology Development/Training		
B.A., Arizona State University; M.A., Prescott College; M.Ed., University of Phoenix			
SCHROEDER, GREGG	Athletic Specialist		
B.A., Purdue University; M.Ed., Arizona State University			
SHIPLEY, DEE	Director, Financial Aid		
A.A., Scottsdale Community College; B.A., Ottawa University (KS); M.Ed., Northern Arizona University			
SKRIVANEK, GREG	Coordinator, Learning Center		
B.A., Southern Methodist University			
SMITH, NOEL	Coordinator, Nursing Assistant Program		
B.S., Lewis University (MO)			
STAUTH, DARREN	Supervisor, Network Services		
B.A., Kansas State University			
TATE, SIDNE	Director, Computer Lab & Instructional Services		
B.A., Northern Illinois University; M.A., Arizona State University			

Faculty

ARAGONA, JARED (2005)	Instructor, English
B.S., Cornell University; B.A., University of New Mexico; M.A., Ph.D., University of Arizona	
ASHBY, PATRICIA (1998)	Professor, Biology
B.A., Ph.D., University of New Mexico	
ATTANUCCI, FRANK (1990)	Professor, Mathematics
B.S., M.A., Arizona State University	
AVIANANTOS, JOHN (2004)	Instructor, Physical Education
B.A., M.A., Arizona State University	
BAKER, CHARLES (2003)	Instructor, Administration of Justice
B.S., M.S., University of Louisville; Ed.D., Arizona State University	
BALLARD, MARSHA (2000)	Librarian
B.A., Texas Christian University; M.L.S., University of Arizona	
# BARNES, ROY A. (1994)	Professor, Biology
B.S., Colorado State University; M.S., Arizona State University	
# BECKER, ART (1975)	Professor, Physical Education
B.S., M.S., Arizona State University	
BIGLIN, KAREN (1985)	Librarian
B.A., M.L.S., University of Arizona	
£ BODELL, PATRICIA (1987)	Professor, Physical Education
B.F.A., M.F.A., University of Utah	
# BORICK, STEVEN (1999)	Professor, Chemistry
B.A., Oberlin College (OH); Ph.D., Princeton University (NJ)	
# BRANDT, SHEILA (2001)	Professor, Computer Information Systems
M.S., Ph.D., University of Arizona	

* Division Chairperson	# Department Chairperson
£ Program Director	

Administration, Management & Faculty

*£ BROWER, MYRON R. (1982) B.A.Ed., B.A., Architecture, Arizona State University; M.A., Architectural History, University of Virginia	Professor, Architectural Technology/CAD	DUECK, PATRICIA (2000) B.A., Arizona State University; M.S., Northern Arizona University	Professor, Mathematics
£ BROWN, DAVID (2003) B.S., M.A., Brigham Young University; Ph.D., University of Maryland	Instructor, HPERD	ELAM, JAMES (1990) B.A., University of North Carolina; M.M., M.Ed., Arizona State University	Professor, Computer Information Systems
BRUISED HEAD, DEBBIE "TIA" (2000) B.A., B.S., M.A., Northern Arizona University	Counselor	ELLIS, JOHN (1998) B.A., M.A., University of Arizona	Professor, Spanish
BUNTING, LARRY (1977) B.S., M.S., Eastern Illinois University; Ed.D., Northern Arizona University	Media Librarian	* ELLS, BETH (1983) B.A., M.A., Arizona State University	Professor, Art and Humanities
# BUTTON, LEON (CPA)(1989) B.S., M.B.A., Arizona State University	Professor, Business and Accounting	# FAHEY, BARBARA (1984) B.A., University of California/L.A.; M.A., Ph.D., Arizona State University	Professor, English
# CALOGERO, SIRIO (2002) M.A.J.D., University of Rome, Italy	Instructor, Italian	FITZGERALD, LAURA (2002) B.A., M.A., California State University;	Instructor, English
# CARRUTHERS, CONNIE (1989) B.A., University of California/L.A.; M.S., California State University/Northridge	Professor, Mathematics	FOSTER, JOHN (2004) B.S., California Institute of Technology; M.A., University of California, Berkeley	Instructor, Chemistry
CHADWICK, KIRBY (1976) B.A., M.A., University of Iowa	Professor, Italian and Spanish	GIOVANDO, KENNETH (1973) B.S., M.A., University of Arizona	Professor, Physical Education
*£ CHALMERS, KAREN (1998) B.A., University of Arizona	Professor, Culinary Arts	GLAESS, TERRI L. (1996) B.A., Northwestern University (IL); M.A., University of Chicago (IL)	Professor, Mathematics
CLARK, PHILIP (2005) B.S., Ohio State University; M.A., Arizona State University	Instructor, Math	* GLASPER, DEBRA (2000) B.A., Luther College (IA); M.A., Governors State University (IL)	Counselor
# COE, EDWARD (2002) B.A.E., M.Ed., Arizona State University	Professor, Mathematics	* GOFF, AMY (1990) B.S., M.S., Texas A & M University	Professor, Physical Education
COMBELLICK, DANIEL (1991) B.S., M.Ed., Arizona State University	Professor, Computer Information Systems	GONZALES, MARCIA (2002) B.S., University of Arizona; M.S.D., Arizona State University	Instructor, Interior Design
CEDERGREN-HEALY, ANNE (2005) B.S., New Mexico Institute of Mining; M.S., University of Illinois	Instructor, Biology	GOTH, RAMONA K. (1998) B.A., Southwest Baptist University (MO); M.A., Central Missouri State University	Professor, English
COOPER, CHARLES (1995) B.S., Arizona State University; A.S.I.D.	Professor, Interior Design	GOUDARD-RYAN, MARIE-FRANCE (1988) B.A., M.A., California State University	Professor, French and Spanish
# COPP, DARRELL L. (1990) B.S., Eastern Michigan University; M.A., Arizona State University	Professor, Communication Arts	# GRAY, BONNIE A. (2001) B.S., M.S., Ph.D., Arizona State University	Professor, Psychology
CUTLER, ALBERT B., III (2000) B.S.E.E., University of Arizona; M.S.E., Arizona State University	Professor, Motion Picture/Television	# GREEN, STEPHEN (1999) B.M.E., M.M., Brigham Young University (UT); D.M.A., Arizona State University	Professor, Music
# DAMASK, NICHOLAS (1997) B.A., M.A., University of Cincinnati; M.A., The American University (DC); Ph.D., University of Cincinnati	Professor, Political Science	GREENWALT, THOMAS (1999) A.O.S., Culinary Institute of America (NY)	Professor, Culinary Arts
DESJARDINS, SANDRA (1998) B.A., University of Arizona; M.A., University of Windsor (Canada); M.F.A., Columbia University (NY)	Professor, English	GUHSE, DONNA B. (1997) B.S., Bob Jones University (SC); M.A., University of West Florida	Professor, Mathematics
DIGGINS, KERI A. (2004) B.A., Framingham State College; M.A., Boston College	Instructor, Sociology	HAAS, ERIC C. (2003) B.A., University of Michigan; M.S., University of Utah	Counselor
£ DLUGOSZ, ROSANNE K. (1975) B.A., M.A.T., Webster College (MO); Ed.D., Arizona State University	Professor, Child Development	HANSEN, THOMAS (2005) B.S., Ohio State University; M.A., Arizona State University	Instructor, Education
DUDLEY, DAVID (2004) B.A., Lamar University; M.A., Arizona State University	Instructor, Mathematics	HARPER, ANNELESE M. (1997) B.S., Southern Utah State University; M.A., New Mexico State University; Ph.D., Arizona State University	Professor, Communication Arts

* Division Chairperson # Department Chairperson
£ Program Director

Administration, Management & Faculty

HAUGEN, PAUL (1992) B.S., St. Louis University (MO); M.N.S., Arizona State University	Professor, Physics	LITTLE CROW, MICHAEL (2004) B.S., M.S., Oregon State University	Instructor, Mathematics
# HERBERT, KATHERINE (2000) B.A., M.A., Arizona State University	Professor, Motion Picture/Television	* LOKEY, PATRICIA (1990) B.A., University of Colorado; M.A., University of Denver (CO); Ph.D., Arizona State University	Librarian
HERNÁNDEZ-HALL, MARIÚ EUGENIA (1999) B.A., San Diego State; M.A., Arizona State University	Professor, Spanish	LORING, ERIC D. (1989) B.A., University of Iowa; M.A., M.LITT, Middlebury College (VT)	Professor, English
# HICKS, LINDA (1991) B.A., Arizona State University; M.A., University of Arizona	Professor, Communication Arts	LUCAS, MIGUEL (2002) B.A., M.C., Arizona State University	Counselor
HINTON, JANINE (2003) B.S., University of the State of New York; M.S.N., University of Phoenix	Instructor, Nursing	MacELVEE, CAMERON R. (2000) B.A.Ed., Arizona State University; M.A.Ed., Northern Arizona University; Ph.D., University of Arizona	Professor, English
HOFFMAN, JANELLE (2003) B.S., Western Michigan University; M.A., University of Phoenix	Instructor, Hospitality	MacKAY, NEIL (2001) B.S., University of Notre Dame; M.S., University of Wisconsin - Madison; Ph.D., Arizona State University	Professor, Biology
HUTCHINSON, DIANA (1984) B.A., M.A., Arizona State University	Professor, Communication Arts	MARTIN, PETER L. (1997) B.S., Valley City State University (ND)	Professor, Computer Information Systems
IVESTER, ELIZABETH (1993) B.S., Brown University (RI); M.S., Arizona State University	Professor, Geology	McCAGE, ANN (2000) B.A., American University of Beirut; M.Ed., Arizona State University	Professor, Reading
JACOBS, SALLY (2002) B.A., Randolph-Macon Woman's College; B.S., M.A., Ph.D., Arizona State University	Professor, Mathematics	McCARTHY, NIALL (2003) B.S., M.A., Trinity College, University of Dublin; MSIM, Arizona State University	Instructor, Computer Information Systems
JENSEN, CHRIS (1990) B.A., Simpson College (CA); M.A., Wheaton College (IL)	Professor, Television/Radio Production	# McKINNEY, ROGER (2002) B.A., Graceland University (IA); M.F.A., American University	Instructor, Art
#£ JOHANSEN, NORMA (1988) B.F.A., Arizona State University; M.B.A., University of Phoenix	Professor, Business	MEACHAM, WILLIAM (2000) B.S., Northern Arizona University; M.C.S., Arizona State University	Professor, Computer Information Sys/Computer Science
£ KAVANAGH, JOHN (1998) B.A., New York University; M.A., St. John's University (NY); Ph.D., Rutgers University (NJ)	Professor, Administration of Justice Studies	* MEDEIROS, PATRICIA (1989) B.A., Lake Forest College (IL); M.A., Ph.D., University of Massachusetts	Professor, English
£ KING, GERA (1990) B.S., University of Kentucky; A.S.I.D.; M.A.B.M., University of Phoenix	Professor, Interior Design	MEHRABAN, MITRA (2004) B.S., Grand Canyon University; M.Ed., Northern Arizona University	Counselor
KLOBAS, MARK (2002) B.A., University of Arizona; M.A., Ph.D., Texas A & M University	Instructor, History	MEREDITH, STEVEN (1989) B.M., M.M., University of Utah; D.M.A., Arizona State University	Professor, Music
KULIKOWSKI, KATHIE (2006) B.A., Portland State University; M.S., California College of Health Sciences	Instructor, Nursing	MILLER, JANICE J. (1999) B.A., M.A., Washington State University; Ph.D., Arizona State University	Professor, History
# KUMAR, DILIP (1984) B.A., M.A., University of Mysore, India; M.A., University of Akron (OH)	Professor, Economics	MILLER, KATHY (2005) B.S.N., University of Phoenix; M.S.N., University of Phoenix	Instructor, Nursing
KUZMIK, MICHAEL L. (1998) B.A., Architecture, Arizona State University	Professor, Architectural Technology/CAD	MONROIG, RONALD (2003) B.S.E.E., University of Colorado; M.B.A., University of Phoenix	Instructor, Computer Information Systems
LAREY, TIMOTHY (2005) B.A., Texas Tech University; Ph.D., University of Texas	Instructor, Psychology	MOORE, JAMIE (1991) B.A., M.A., Slippery Rock University (PA)	Professor, English
LEMONS, GARY (1994) B.S., Oklahoma City University; Ph.D., University of New Mexico	Professor, Sociology	MOORE, SUSAN (1993) B.A., M.A., Arizona State University	Professor, English
LIFFITON, JOHN (2001) B.S., Northern Arizona University; M.A., Arizona State University	Professor, English as a Second Language	MUGFORD, ROBERT B. (1979) B.A., University of Connecticut; M.A., Arizona State University	Professor, English

* Division Chairperson	# Department Chairperson
£ Program Director	

Administration, Management & Faculty

MUTZ, STEPHEN (1996) B.A., University of California/Berkeley; M.S., San Diego State University	Professor, Physics and Astronomy	* RICKER, JEFFRY P. (1995) B.S., M.A., Ph.D., University of Illinois/Champaign-Urbana	Professor, Psychology
NAGANO, MICHAEL (1991) B.A., University of Washington; M.S., Arizona State University	Professor, Economics	ROBINSON, JANET (2004) B.A., Arizona State University; M.Ed., University of Phoenix	Instructor, Humanities
NAGY, JOHN D. (1998) B.S., Eastern Michigan University; B.S., University of Michigan; Ph.D., Arizona State University	Professor, Biology	RUIZ-SCOTT, LAURA (1995) B.A., M.C., Arizona State University	Professor, Spanish
NANCE, LINDA (1991) B.S.N., M.S.N., University of Central Arkansas	Professor, Nursing	* SAWYER, DOUGLAS (1992) B.A., Coe College (IA); Ph.D., Iowa State University	Professor, Chemistry
NEARING, DANIEL (1997) B.S., M.A., Central Michigan University	Professor, Mathematics	SCHLAPKOHL, SUZETTE (1987) B.A., Northern Illinois University; M.Ed., Arizona State University	Professor, English and Reading
* NELSON, NELLIE F. (1989) B.S.N., Murray State University (KY); M.S.N., University of Virginia	Professor, Nursing	SCHMIDT, EUGENE (1980) B.A., Wayne State University (MI); M.S., Arizona State University	Professor, Psychology
NOVAK, CHRISTINA D. (1999) B.A., Pennsylvania State University; D.M.A., Arizona State University	Professor, Music	SERAFIN, NIKKI N. (2004) B.A., Arizona State University; M.Ed., Northern Arizona University	Instructor, English as a Second Language
O'BRIAN, LEONARD (1999) B.S., Illinois State University; M.A., University of Illinois; M.A., M.Th., D.M., University of Chicago (IL)	Professor, Philosophy	#£ SERRANO, PAT (1987) B.S., Indiana University; M.Ed., Arizona State University	Professor, Computer Information Systems
* O'BRIEN, EDWARD J. (1989) B.B.A., M.S., Pace University (NY)	Professor, Business	£ SFERRA, BOBBIE (2002) B.A., M.Ed., Ph.D., Arizona State University	Instructor, Education
O'NEILL, DOMINIC (1988) A.A.S., Scottsdale Community College	Professor, Culinary Arts	SHAFFER, JOHN (2004) B.S., M.A., Ph.D., Arizona State University	Instructor, Geography
ORTIZ, JOSEPH (1989) B.S., Lamar University (TX); M.A., Eastern New Mexico University; Ed.D., Arizona State University	Professor, Communication Arts	SHANK, ALBERT (2000) B.A., M.T., University of Virginia; M.A., Arizona State University	Professor, Spanish
PEACE, LISA (2002) B.F.A., University of New Hampshire; M.F.A., Arizona State University	Instructor, Art	# SICKAFOOSE, JOHN P. (1994) B.S., University of Arizona; Ph.D., Iowa State University	Professor, Chemistry
PETERSON, SUSAN A. (1998) B.A., University of Oklahoma; Diploma, University of Aix/Marseille; M.B.A., University of Pennsylvania	Professor, Business	£ SIKES, CARLYN (2003) B.A., University of Colorado; M.F.A., Arizona State University	Instructor, Yoga
PFLANZ, CHARLES (1989) B.A., Humboldt State University (CA); M.A., Arizona State University	Professor, Economics	£ SIMPSON, JIM (2001) B.S., M.Tax, Arizona State University	Professor, Computer Information Systems
£ PINO, MANUEL F. (1996) B.A., M.A., University of New Mexico	Professor, Sociology	SLAUSON, ELIZABETH (2001) B.S., Augsburg College; B.S., M.S., Ph.D., Arizona State University	Professor, Biology
PRICE, PENELOPE (1994) B.A., University of Arizona; M.A., Ph.D., Arizona State University	Professor, Motion Picture/Television	STEIN, JOEL (2004) B.A., Macalester College; M.S., University of Wisconsin-Madison	Instructor, Biology
QUINN, JENNIFER (1986) B.S.N., M.S.N., Arizona State University	Professor, Nursing	STROM, APRIL (2005) B.A., M.A., Texas Tech University	Instructor, Mathematics
RAWLINGS, KYLE (1985) B.S., Ph.D., Arizona State University	Professor, Physics	TEMPLE, PAULA (2005) B.S., Southern Utah University; M.Ed., Utah State University	Instructor, Mathematics
REYES, MIRIAM (2004) B.S.N., M.S.N., University of Miami	Instructor, Nursing	THORLAKSDOTTIR, ANNA (2002) B.F.A., M.F.A., Arizona State University	Instructor, Motion Picture/Television
RIBAS, ROBERTO (2002) B.S., Central Missouri State; M.A., University of California	Professor, Mathematics	THURMAN, GERALD (1997) B.S., Whitewater University (OH); M.S., Purdue University (IN)	Professor, Computer Information Sys/Computer Science
		TRELOAR, LINDA (1993) B.S.N., M.A., University of Iowa; Ph.D., Union Institute (OH)	Professor, Nursing

* Division Chairperson # Department Chairperson
£ Program Director

Administration, Management & Faculty

TROLLEN, THOMAS (1983)	Professor, Business/Computer Information Systems
A.E.T., B.A., Southwest State University (MN);	
M.B.A., Arizona State University	
TUALLA, LARRY (2002)	Instructor, English
B.A., M.A., Northern Arizona University	
TURNER, LARRY (2005)	Instructor, Administration of Justice Studies
B.S., University of Mississippi	
# URAN, TED (2002)	Instructor, Art
B.A., B.F.A., Southern Illinois University;	
M.F.A., Arizona State University	
VALLE, MICHAEL S. (2002)	Instructor, Philosophy
B.A., University of Minnesota;	
M.A., University of Illinois;	
Ph.D., Arizona State University	
VICICH, JAMES A. (1995)	Professor, Mathematics
B.S., Northern Illinois University;	
M.S., Ph.D., Arizona State University	
WARD, GARY (2001)	Professor, Hospitality and Tourism
B.A., Cleveland State University;	
M.B.A., University of Phoenix	
WARD, KATHY (2004)	Instructor, Nursing
B.S.N., M.S.N., Arizona State University	
WESER, JOHN T. (1996)	Professor, Biology
B.S., M.N.S., Ph.D., Arizona State University	
# WESER, PAUL (1990)	Professor, Geography
A.A., Mesa Community College (AZ);	
B.S., M.A., Arizona State University	
WHELAN, MICHAEL (1998)	Professor, Culinary Arts
B.F.A., Brooks Institute (CA)	
£ WILLIAMS, LARRY L. (1993)	Professor, Hospitality and Tourism
B.S., Arizona State University;	
M.B.A., University of Phoenix	
WILLIAMSON, KIMB (1980)	Professor, Theater Arts
B.A., M.A., Northern Colorado University	
WILSON, MEREDITH (2003)	Instructor, Geology
B.A., Augustana College (IL);	
M.S., Arizona State University	
WOODBURN, RACHEL L. (1998)	Professor, Art
B.F.A., University of Michigan	
WORTH, KEITH A. (1983)	Professor, Mathematics
A.A.S., Arizona Western College;	
B.S.E.E.T., M.S., Arizona State University	
YOU, ROBERT (2000)	Professor, Art
B.A., Northeast Missouri State University;	
M.F.A., University of North Carolina	

Faculty and Administration Emeritus

Abbruscato, Joseph J. B.B.A., M.B.A.	Kendall, William D., B.A., M.A.
Baumgart, Edward J., B.A., M.A.	LeMoine, Kenneth R., B.A., M.A.
Belsher, Brian E., M.C.	Lippert, Nancy M., B.A., M.A.
Booher, Jerry G., B.S.M.E., M.S.E.S.	Little, Gloria R., M.B.A., Ph.D., Ed.D.
Bradley, Patricia A., B.S., M.A.	Losse, John, B.S., M.S.
Brock, Patsey A., B.A., M.A.	Martin, William J., B.A., M.A.
Brooke, Edna M., B.S., M.A.	Massion, Dennis D., B.A., M.S., Ph.D.
Burley, John, B.M., B.M.Ed., M.S., Ed.D.	Miller, Nancy L., A.B., M.A.Ed., Ph.D.
Chandler, Edgar, B.A., M.A.	Miller, Robert W., B.S., M.S., Ph.D.
Combs, Bernard, B.S., M.S.	Munn, Ruth S., B.S.N., M.A.
Coracides, Carmen J., B.A., M.A., Ph.D.	Nelson, Anita J., B.A., M.A.
Cox, Ruth R., B.Ed., M.A.	Overley, Winifred (T. J.), B.A., M.A., M.N.S.
Crutchfield, Julie, B.A., M.A.	Pirman, Mary R., B.S.N., M.S.N.
Darland, Fara G., B.A., M.A.	Richards, Rita A., B.A., M.A.
Deck, Larry S., B.A., M.A., M.F.A.	Saffron, Stephen, B.A., M.A.
Dugan, Thomas F., B.S., M.A., Ed.D.	Scharf, Lorraine L., B.S., M.A.
Dyer, Clarence R., B.S., M.A., M.F.A.	Schwarz, Kathryn J., B.S., M.A., Ph.D.
Everroad, Edward K., B.A., M.A.	Scudder, John R., B.A., M.A.
Ferguson, Christine, B.A., M.M.C., Ed.D.	Sessions, Charles M., B.M., M.M.Ed., D.M.A.
Fields, Pamela B., B.A., M.A.	Shaffer, Gary M., B.S., M.S.
Gillett, Kathleen P., B.A., M.S.	Silberman, Philip L., B.S., M.S.
Greenwell, James R., B.S., M.S., M.A., Ph.D.	Sklar, David, B.A., M.F.A.
Groenke, Glenn, B.S., M.S., Ed.D.	Slater, Rodger D., B.S.Ed., M.S., Ph.D.
Gyrko, Eugene R., B.S., M.A.	Snow, Donald H., B.A., Ph.D.
Hackett, Donald G., B.A., M.A.	Steinmann, Phyllis, M.A.
Howard, Sharon, B.S., M.L.S.	Taylor, Annie A., B.A., M.A., Ph.D.
Jacobs, Alan, B.A., M.A.	Tobiason, Rolf V. (Toby), B.A., M.A., Ed.D.
Jensen, Ava Lynn, B.A., M.A., M.C., Ph.D.	Via, L. L., B.S., M.A.
Jenson, Norman C., B.A., M.M.	Walker, Herman, B.S., M.A., Ph.D.
Johnson, Donald R., B.A., M.A.	Wambach, Julie A., B.S., M.A., Ph.D.
Kearns, Ronald L., B.A., M.A.	Werner, Donald A., B.A., M.A., Ed.D.
Keefe, Richard C., B.A., M.A., Ph.D.	Winters, Robert C., B.A., M.A.
Kelly, Suzanne V., B.A., B.S., M.S., Ph.D.	Wyatt, Jeannie, B.S., M.Ed., Ph.D.

INDEX

A

Absences, Official and Unofficial	27
Abuse of Alcohol/Drugs Policy	224
Academic Advising Policy	21
Academic Calendar	Inside Front Cover
Academic Certificate	61
Academic Load	27
Academic Misconduct Policy	229
Academic Probation/Suspension	28
Academic Progress for Financial Aid	25
Academic Renewal	32
Access to Educational Records	233
Accident Insurance for Students	211
Accidents on Campus	214
Accounting (ACC) Program	78, 118
Accreditation Statement	1
ACE (American Council on Education) Evaluation/Credit	13
ACT Scores	15
Activities Calendar	213
Administration and Management	237
Administration of Justice Studies (AJS) Program	74, 118
Admission with Advanced Placement	14
Admissions and Records Office	207
Admissions Criteria for Veterans	13
Admissions Information	10
Admissions Policy and Guidelines	9
Admissions, Special Status	9
Admissions Classifications	9
Adult Re-entry Services	207
Advanced Placement Examinations	14
Advertising Arts (ADA) courses	124
Advisement, Academic	21
Advisement Center	207
Aeronautics (AET) courses	121
Aerospace Studies (AES) courses	121
Affirmative Action Statements	6
AGEC Course Designations and Matrix	36
Agricultural Science (AGS) course	122
AIDS Guidelines and Policy	226
Alcohol Abuse Policy	224-226
Alien In-state Student Status	12
American Council on Education (ACE)	13
American Indian Arts Institute (AIAI)	75
American Indian Program	207
American Indian Studies (AIS) Program	116, 122
American Sign Language (SLG) courses	200
Americans with Disabilities Act (ADA)	6, 209, 227
Anthropology (ASB and ASM) courses	123
Appeal of Sanctions for Academic Misconduct	228
Appeal Process (Financial Aid)	26
Archaeology (ASB) courses	123
Architectural Technology (CAD) (ARC) Program	75, 123
Arizona General Education Curriculum (AGEC)	33
Art: Advertising (ADA) courses	124
Art: Computer (ART) courses	124
Art: Photographic (ART) courses	126
Art: Visual (ART) courses	126
Art Humanities (ARH) courses	128
Artichoke Grill	209
Articulation Transfer Guidelines	19
Assessment and Course Placement Policy	21
Assessment, Educational	13, 211
ASSET Testing	211
Assistance, Financial	25, 209
Associate in Applied Science Degree (AAS)	60
Associate in Arts Degree (AA)	41
Associate in Arts in Elementary Education Degree (AAEE)	43
Associate in Business-General Requirements Degree (ABus-GR) ...	53
Associate in Business-Special Requirements Degree (ABus-SR) ...	55
Associate in General Studies Degree (AGS)	58
Associate in Science Degree (AS)	51
Associate in Transfer Partnership Degree (ATP)	57
Astronomy (AST) courses	128
Athletics, Men's	210
Athletics, Women's	212
Attendance Policy and Requirements	27
Attendance, Previous College	10
Audio Production Technologies (MTC, MUC) Program ..	108, 187-188
Audit Courses	28
Awarding Transfer Credit	19
A.W.A.R.E.	207
AZCAS Transfer Planning Guides	20, 40

B

Biology (BIO) courses	129
Blue Light Security Phone	214
Bookkeeping Certificate of Completion	79
Bookstore Policies	214
Broadcast Production Certificate of Completion	106
Building Safety and Planning Technology (BLT) Program ...	76, 130
Building Safety Technology Certificate of Completion	76
Bulletin Board Policy	214
Bursar/Cashier's Office	207
Bus Service	207
Business (FASTRACK) Program	77, 118, 131, 177, 178, 180
Business (GBS) Program	78, 131
Business-Personal Computers (BPC) Program	80, 132

C

CAD (ARC) courses	123
Cafeteria	209
Calculators, Use of (Testing Center)	211
Calendar, Academic	Inside Front Cover
Calendar, Campus Events	213
Campus Hours	214
Campus Map	Inside Back Cover
Campus Policies	214
Campus Security Act	220
Campus Tours	210
Canceled Classes, Refunds	24
Career Counseling	208
Career & Cooperative Education Services	208
Cashier's Office (see Bursar/Cashier's Office)	207
Catalog Year, Determining	64
CEEB Test Scores	14
CEG (Course Equivalency Guide)	20
CELSA Testing	211
Certificates Offered at Maricopa Skill Center	72
Certificates Offered at SCC	3
Chairpersons and Instructional Divisions	4
Check Cashing Policy	207
Chemistry (CHM) courses	133
Child Enrichment Center	208
Child/Family Studies (CFS) courses	134
Children on Campus Policy	220
Chinese Language (CHI) courses	135
Cisco Network Technology (CNT) courses	136
Civil Engineering Technology (CET) course	136
Classifications, Student	9
CLEP Chart	16
Clubs and Organizations for Students	208
College Addresses/Phone Numbers/Websites (MCCCD)	5
College Entrance Examination Board (CEEB)	14
College-Level Examination Program (CLEP)	14
College Management Personnel	237
College Offices and Phone Numbers at SCC	5
College Safety Policies	214
College Websites	5
Communication Arts (COM) courses	136
Complaint Resolution Process, Non-Instructional	30
Computer-Aided Drafting (ARC) courses	123
Computer Hardware/Network Support Certificate of Completion	80
Computer Information Systems (CIS) Program	81, 137
Computer Lab, Open	210
Computer Science (CSC) Program	85, 142
Concurrent Enrollment in Higher Education Institutions	13
Conference and Meeting Rooms	210
Conservatory Theatre, Summer (Shakespeare)	205
Constitution, Arizona and U.S. (POS) courses	197

Cooperative Education	142
Copyright Act Compliance Policy	221
Corporate Computer Technology (CCT) courses	143
Council for Adult and Experiential Learning (CAEL)	13
Counseling and Personal Development (CPD) courses	143
Counseling Services	208
Course Applicability System (CAS or AZCAS)	20, 40
Course Equivalency Guide (Arizona's Colleges/Universities)	20
Course Placement	21
Course Prefix List	117
Coursework Time Limits	63
Credit by Evaluation (ACE, Departmental)	13
Credit by Examination (Departmental)	15
Credit by Examination (HCIES)	19
Credit by Skills Demonstration-Assessment (HCIES)	19
Credit for ACT-PEP	15
Credit for CLEP Scores	14
Credit for Military Service	13
Credit for Prior Learning	13
Credit for the DANTES Examination Program	15
Credit for Training Programs (CREDIT)	14
Credit/No Credit (P/Z) grade	28
Credit Transferred	19
Crime Awareness and Campus Security Act	220
Crime Scene Investigation Certificate of Completion	73
Crime Scene Technology Certificate of Completion	73
Critical Reading (CRE) courses	144
Culinary Arts (CUL) Program	86, 145
Culinary Arts, Adv. Professional Certificate of Completion ...	86
Culinary Arts Dining Room	209

D

Dance Technology (DAN) Program	88, 147
Dance Humanities (DAH) courses	149
DANTES, Credit for	15
Database Development Certificate of Completion	80
Debts, Outstanding	24
Deadlines for Students	29
Degree Requirements	62
Degrees/Certificates Offered at SCC	3, 33-116
Desert Oasis Dining Room	209
Determination of Catalog Year for Graduation	64
Directory, Offices and Phone Numbers at SCC	5
Directory, Student	234
Disability Resources and Services	209, 227
Disciplinary Code	230
Disciplinary Standards	229
Discrimination Complaint Procedures for Students	215
District Policies	6
Drafting: see Architectural Technology (ARC) courses	123
Drop/Add (Schedule Changes)	27
Drug/Alcohol Abuse Policy	224

Index

E

Early Childhood Development (ECH) Program	89, 150
Early Education (EED) courses	151
Economics (ECN) courses	151
Editing Certificate of Completion	107
Education (EDU) courses	152
Educational Assessment	13
Educational Credit by Examination	14
Educational Records, Access to	233
Emergency Evacuation Procedures	214
Emergency Medical Technology (EMT) Program	90, 155
Emergency Vehicle Assistance	214
Emissions Control Compliance Policy	22
Engineering Science (ECE) Program	91, 157
English (ENG) courses	158
English as a Second Language (ESL) courses	159
English Humanities (ENH) courses	162
Entrepreneurial Studies (EPS) courses	164
Equal Opportunity Statement	6
Equine Science (EQS) Program	91, 164
Equivalency Examinations, College-Level	14
Evaluation, Credit by	13
Examination, Departmental Credit by	15
Exercise Science (PED) courses	195

F

Facility Requests	209
Faculty and Administration Emeritus	242
Faculty Lectures Policy, Taping of	222
Faculty Personnel	238
Family and Consumer Science (FCS) courses	165
Family Educational Rights & Privacy Act of 2054 (FERPA) ..	233
Family Life Education Program	92
Fastrack Business courses	118, 131, 177, 178, 180
Fees Schedule and Payments	22
Film Analysis and Criticism Certificate of Completion	107
Film Production Certificate of Completion	107
Financial Aid Disbursement	25
Financial Assistance	25, 209
Financial Clearance of Outstanding Debts	24
Fire Academy Certificate of Completion	93
Fire Science (FSC) Program	93, 165
Fitness and Wellness Center	196
Food and Nutrition (FON) courses	167
Food Services	209
Foreign Language courses	167
Foreign Students (Nonimmigrant) Admissions	9
Forensic Science (FOR) Program	74, 167
French Language (FRE) courses	167
Fundraising Policy	214

G

General Business (GBS) courses	131
General Education Designations	63
General Education Statement	63
General Education Degree Requirements - AAS	60
General Education Degree Requirements - AGS	58
General Technology (GTC) courses	168
Geography, Cultural (GCU) courses	168
Geography, Physical (GPH) courses	169
Geology (GLG) courses	169
German Language (GER) courses	170
Golf Management (HRM) Program	97-98, 173
Governing Board Members	237
Grade Point Average for Graduation	62
Grades and Grading Policies	27
Graduate Guarantee Policy	62
Graduation, Catalog Year	64
Graduation Grade Point Average	62
Graduation Requirements	62
Graduation with Honors	62
Graphic Design Program	94
Grievance Process, Instructional	30

H

Hazing Prevention Regulation	223
HCIES Competency Assessment Tests (CATs)	19
Health Care Integrated Education Systems (HCIES)	19, 95
Health Care Related (HCR) courses	170
Health Core Curriculum (HCC) courses	170
Health Science (HES) courses	171
History (HIS) courses	172
Holidays, Absence for	27
Honor List, President's	32
Honors, Graduation with	62
Honors Program	32, 209
Hospitality & Tourism/Golf Mgt. (HRM) Program ..	97-98, 173
Hospitality & Tourism/Hotel Mgt. (HRM) Program	98, 173
Hospitality & Tourism/Restaurant Mgt. (HRM) Program ..	99, 173
Housing	209
Humanities, Art (ARH) courses	128
Humanities, Dance (DAH) courses	149
Humanities, English (ENH) courses	162
Humanities (HUM) courses	174

I

Important Deadlines for Students	29
Incomplete Grade Policy	28
Indian Program (American)	207
Infant/Toddler Development (ITD) Program	100, 175
Information Studies (IFS) courses	175

Index

In-state Student Status	11	Motion Picture/TV Production (TCM) Program	105, 184
Instructional Divisions	4	Music Business (MTC, MUC) Program	108, 187-188
Instructional Grievance Process	30	Music: Commercial and Business (MUC) courses	188
Insurance, Accident Injury	211	Music: History and Literature (MHL) courses	187
Interior Design (INT) Program	100, 175	Music: Performance (MUP) courses	189
Interior Design: Professional Level Certificate	101	Music: Private Instruction (MUP) courses	189
International Baccalaureate Diploma/Certificate	18	Music: Theory and Composition (MTC) courses	187
International Business (IBS) courses	177		
International Education Programs	210	N	
Italian Language (ITA) courses	177		
<hr/> J <hr/>			
Japanese Language (JPN) courses	178	Network Administration (CIS) Program	82, 137
Journalism (JRN) courses	178	Nondiscrimination Policy	6
Journalism Certificate of Completion	101	Nonimmigrant Students	9
Justice Studies Certificate of Completion	73	Non-instructional Complaint Resolution Process	30
<hr/> L <hr/>			
Library Services	210	Nurse Assisting Certificate of Completion	110
Licensure Disclaimer	63	Nursing: Continuing Education (NCE) course	191
Limit for University Coursework	63	Nursing Science (NUR) Program	110, 191
Lost and Found	214		
LPN Curriculum	110	O	
<hr/> M <hr/>			
Mailboxes	210	Occupational Programs of MCCCDCD	69
Management Certificate of Completion	79	Office Automation Systems (OAS) Program	112, 194
Management (MGT) courses	178	Office Fundamentals Certificate of Completion	111
Management Personnel	237	Online Application and Registration	210
Map, Campus	Inside Back Cover	Open Computer Lab	210
Map, East Valley Area	248, Back Cover	Orientation Program for Students	210
Maricopa Online Student System	210	Outcomes Assessment	8
Microsoft Applications Development Program	104	Outstanding Debts	24
Marketing Certificate of Completion	79		
Marketing (MKT) courses	179	P	
Mass Communications (MCO) courses	180		
Mathematics (MAT) courses	180	Parent Education Certificate of Completion	92
Mathematics/Science Tutoring Center	212	Parking Fines	23
Meeting and Conference Rooms	210	Parking Regulations	214
Men's Athletics	210	Personal Computer Applications (BPC) Program	80, 132
Microsoft Applications Development Program	104	Personal Web Site Standards	223
Microsoft Networking Technology (MST) Program	103, 183	Petition Signature Solicitation	219
Microsoft Product Specialist Certificate of Completion	102	Phi Theta Kappa	210
Microsoft Systems Administration Certificate of Completion	102	Philosophy (PHI) courses	194
Microsoft Systems Engineer Certificate of Completion	102	Phone, Security (Blue Light)	214
Military Science (MIS) courses	184	Photographic Arts (ART) courses	124
Military Service Credit for Prior Learning	13	Physical Education (PED) courses	195
Misconduct Policy Statement	228	Physics (PHY) courses	197
Mission Statement for MCCCDCD	8	Pima Language (PIM) courses	197
Mission Statement for SCC	1	Placement Testing	211
		Planning/Development Technology Certificate of Completion	76
		Police Academy Preparation Certificate of Completion	73
		Policy Statements	6
		Political Science (POS) courses	197
		Practical Nursing Certificate of Completion	110
		Prefix List, Course	117
		Pre-professional Programs	198

Index

President's Honor List	32
Previous College Attendance	10
Prior Learning, Credit for	13
Probation, Academic and Continued	28
Probation, Disciplinary	232
Programming and System Analysis (CIS) Program	83, 137
Proof of Residency	12
Psi Gamma Chapter	210
Psychology (PSY) courses	198

R

Reading, Critical (CRE) courses	144
Reading English as a Second Language (RDG) courses	162
Reading (RDG) courses	162, 199
Real Estate (REA) courses	199
Records Policy	233
Recreation (REC) courses	199
Recreation Management Program	112
Re-entry Services, Adult	207
Refund Policy	24
Refunds and Repayment of Financial Aid	26
Refunds, Bookstore	214
Registration Policy	22
Religious Holidays, Absence for	27
Religious Studies (REL) course	200
Removal from Class	229
Repeating a Course	28
Residency Guidelines	10
Restaurant Management Program	99
Retail Management/Marketing Certificate of Completion	79
Rights of Access to Educational Records	233

S

Safety Office	214
SAT Scores	9
Schedule Changes (Drop/Add)	27
Schedule of Tuition and Fees	22
Scholastic Standards	27
Science Tutoring	212
Screenwriting Certificate of Completion	106
Security Phone Blue Light	214
Senior Adult Education Program	211
Servicemen's Opportunity College	19
Sexual Harassment Policy	218
Shakespeare Summer Conservatory Theatre	205
Sign Language, American (SLG) courses	200
Skills Demonstration Assessment (HCIES)	19
Small Business Management Certificate of Completion	79
Social/Behavioral Sciences Independent Study Lab	212
Society and Business (SBU) course	131

Sociology (SOC) courses	202
Software Development Certificate of Completion	81
Solicitation Policy	219
Southwest Shakespeare Conservatory Theatre	205
Southwest Studies Program	202
Spanish Language (SPA) courses	203
Special Projects	203
Special Status Students	9
Specialized Vocational/Training Admission	9
Standards, Disciplinary	229
Standards, Scholastic	27
Standards, Technology Resource	222
Statement of Values for MCCCCD	8
Storytelling (STO) courses	203
Strength/Conditioning Personal Trainer Cert. of Completion	94
Student Academic Misconduct Policy	229
Student Accident Insurance	211
Student Application Online	210
Student Assessment	21
Student Classifications	9
Student Deadlines	29
Student Directory	234
Student Disciplinary Code	230
Student Employment	234
Student Financial Assistance	25, 209
Student Governance	235
Student Handbook	207
Student Identification Number	10
Student Leadership Forum (SLF)	211
Student Life & Leadership Programs/Services	211
Student Loans	25
Student, Nonimmigrant (F1)	9
Student Orientation Program	210
Student Right to Know Act	220
Student Services	207
Student Status	10
Student, Suspended	28
Students, Disabled	209, 227
Students in Special Status	9
Students, Transcripts for Transfer	22
Substance Abuse/Misuse Statement	224
Summer Shakespeare Conservatory Theatre	205
Suspension, Disciplinary	229

T

Taping Faculty Lectures Policy	222
Teacher Certification Preparation Program	115
Technology Resource Standards	222
Telecommunication (TCM) courses	184
Television Production (TCM) courses	184

Index

Testing Center	211
Theatre Arts (THE and THP) courses	115, 204
TOEFL (Test of English as a Foreign Language)	9, 159
Tours, Campus	210
Transcripts	13, 22
Transfer Articulation Guidelines	19
Transfer Credit	19
Transfer Information	19
Transfer Partnership Degree, Associate in	57
Transfer Planning Guides (AZCAS)	20, 40
Transfer Students	19
Translation and Interpretation (TRS) courses	206
Tribal Development Program	116
Tuition and Fees	22
Tutoring: Language, Math, Science, Writing	212
Typing (BPC/OAS) courses	132, 194

U

University Transfer Guides	20, 40
----------------------------------	--------

V

Value Statement for Mathematics	180
Values Statement for MCCCDC	8
Vending Machines on Campus	209
Veterans Admissions Criteria	13
Veterans Cooperative Education Credit	142

Veterans Educational Assistance	26
Veterans Services	212
Visa Categories	12
Vision Statement for MCCCDC	8
Vocational Training Program/Specialized Admissions	9
Volunteerism	212
Voter Registration	212

W

Weapons on Campus Policy	214
Web Design Program	84
Web Development Program	85
Websites for SCC	5
Websites, Personal	222
Weight Training (PED) courses	196
Wellness Education (WED) courses	206
Withdrawal Deadlines	Inside Front Cover, 29
Withdrawal Procedures	31
Women's Athletics	212
Women's Studies (WST) courses	206
Word Processing Certificate of Completion	111
Workplace Violence Prevention	220
Writing Center (Tutoring)	212

Y

Yoga Instruction (PED) Program	83, 195-196
--------------------------------------	-------------

How to Find Scottsd

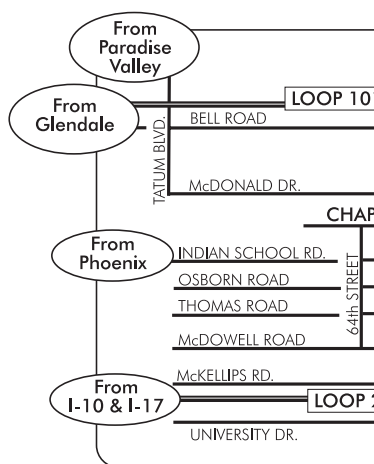

Community College

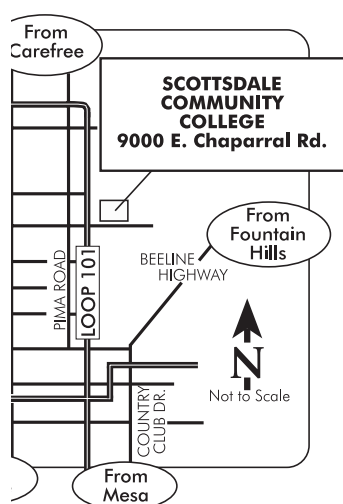

SCOTTSDALE COMMUNITY COLLEGE CAMPUS MAP

- | | | |
|---|---------------------------------------|---|
| Buildings | Institutional Research | SC Student Center |
| ? Information Center | Mail Room | Advisement Center - SC 118 |
| AB Art Building | Media Center | American Indian Program |
| AD Administration | Public Relations/Marketing | Azurite Meeting Room - SC 172 |
| AP Applied Sciences | Senior Adult Program | Bookstore |
| AVID Lab | Testing Center - LB 165 | Cafeteria |
| Culinary Arts Dining Rooms | LC Language and Communications | Career & Cooperative Education Services |
| Film and Television Studios | Writing Center - LC 379 | Copper Meeting Room - SC 171 |
| BU Business | LS Life Science | Counseling Services |
| Computer Lab - BU 133 | MB Music Building | Disability Resources and Services |
| NAU Partnership Office | Recital Hall - MB 115 | Financial Aid Office - SC 152 |
| CC Child Enrichment Center | ME Mechanical Plant | Food Services |
| CM Computer Technology and Mathematics | NU Nursing | International Education |
| Math/Science Center - CM 441 | Information Center | Peridot Meeting Room - SC 209 |
| FO Faculty Office Building | P Portables | Re-entry Services |
| FW Fitness and Wellness Center | CNUW Office | Student Life and Leadership |
| GO General Offices | PA Performing Arts | Turquoise Meeting Room - SC 164 |
| IT Instructional Technology | PE Physical Education | SN Snack Bar |
| LB Library | North Gym | SS Student Services |
| College Safety | South Gym | Admissions and Records Office |
| Continuing Education | Weight Rooms | Bursar/Cashier's Office |
| Development Office | PS Physical Science | Dean of Students' Office |
| Honors Program - LB105F | SB Social/Behavioral Sciences | Veterans Services (A&R Office SS-136) |
| | Independent Study Lab - SB 158 | |

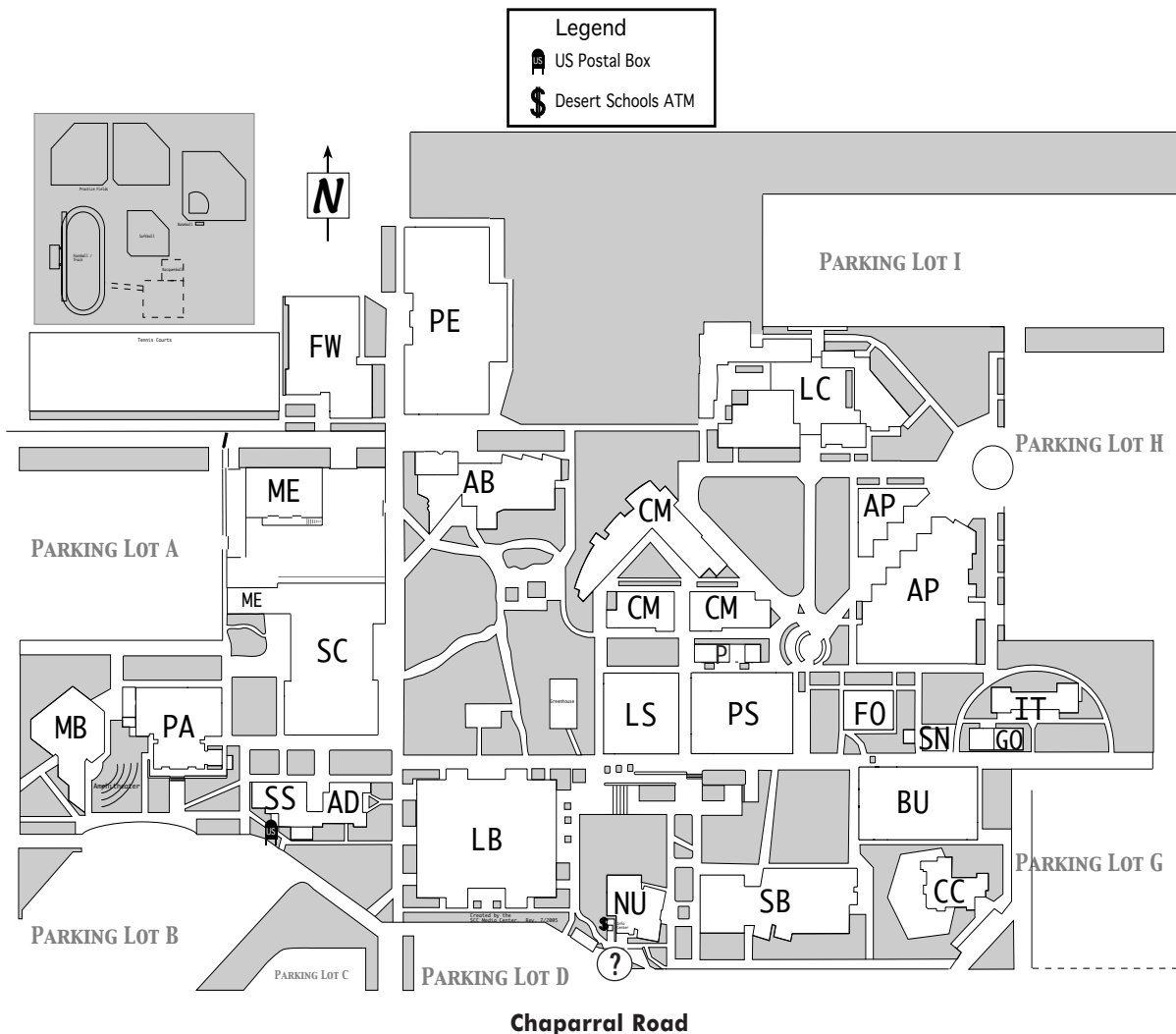

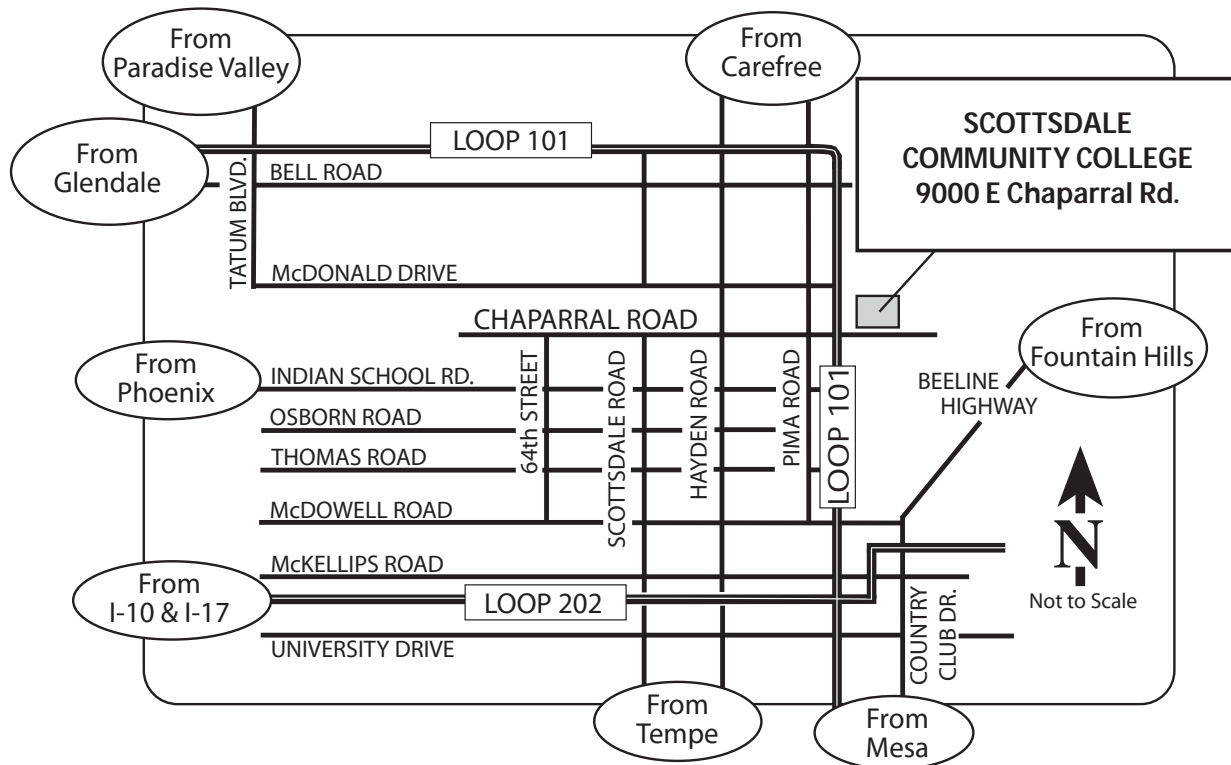

REGISTER BY PHONE OR ONLINE
(480) 423-6100
www.sc.maricopa.edu



Scottsdale Community College

9000 East Chaparral Road, Scottsdale, AZ 85256-2626
 (480) 423-6000/Registration (480) 423-6100

A MARICOPA COMMUNITY COLLEGE

SCOTTSDALE COMMUNITY COLLEGE

2006-2007 Addendum to the College Catalog



Mission Statement

The mission of Scottsdale Community College is to create accessible, effective, and affordable environments for teaching and learning for the people of our communities in order that they may grow personally and become productive citizens in a changing and multicultural world.

About the Addendum

The contents of this addendum supersede the content specified in the 2006-2007 catalog where noted. Contents of the 2006-2007 catalog not revised in this addendum remain in effect. The unrevised content of the 2006-2007 catalog and the revised content of this addendum are valid for the 2006-2007 academic year.

9000 East Chaparral Road
 Scottsdale, AZ 85256-2626
 (480) 423-6000
www.scottsdalecc.edu



Scottsdale Community College is accredited by:

North Central Association of Colleges and Schools
 The Higher Learning Commission
 30 North LaSalle St., Suite 2400
 Chicago, IL 60602
 Phone: 312-263-0456 or 800-621-7440
 FAX: 312-263-7462

TABLE OF CONTENTS

General Information	
Summary of Additions and Modifications.....	2
Admission/Registration/Enrollment	
Tuition and Fees	3
Graduation Requirements	
Summary of Additions and Modifications.....	5
Programs	
Summary of Additions and Modifications.....	6
New Programs	
Culinary Fundamentals.....	7
Strength, Nutrition and Personal Training	7
Hospitality & Tourism/Spa and Wellness Center Management	8
Program Modifications	
Culinary Arts.....	9
Dance Technology.....	10
Equine Science.....	11
Audio Production Technologies (Music).....	12
Nursing	12
Course Descriptions	
Summary of Additions and Modifications.....	13
New Courses Effective Fall 2006	14
Course Modifications	
Effective Summer 2006	15
Effective Fall 2006	15
Effective Spring 2007.....	17
Administration, Management & Faculty	
New Faculty	19
New Faculty Emeritus	19

The Maricopa Community Colleges reserve the right to change, without notice, any materials, information, curriculum, requirements, and regulations published in this catalog addendum.

Dated: 6/29/2006

GENERAL INFORMATION

SUMMARY OF ADDITIONS AND MODIFICATIONS

This section supplements the general college information in the 2006-2007 General Catalog, pages 1-8. The additions and changes to this section are listed below:

Instructional Divisions		
Page	Division/Chair Information	Telephone Number
4	Counseling Chair: Miguel Lucas	480-423-6464

New Prefix		
Page	Prefix Information	Division
4	EPD – Education Professional Development	Social and Behavioral Sciences

ADMISSION/REGISTRATION/ENROLLMENT

This section replaces the tuition and fee information (AR 2.2.9, paragraph B) in the 2006-2007 General Catalog, pages 22-23:

B. Tuition and Fees Schedule

(Effective July 1, 2006, for Fall, Spring and Summer Sessions)

The following is a tuition and fees schedule for 2006-2007 and is provided for reference. These tuition and fees are subject to change. Consult the college's Office of Admissions and Records for fees in effect at the time you intend to register.

Student Status	Total
1. County Resident - Resident Rate - per credit hour General Tuition: \$63.50 <i>plus</i> Fees: \$1.50	\$65.00
2. County Resident - Audit Rate - per credit hour Audit Fee Surcharge: \$25.00 <i>plus</i> General Tuition: \$63.50 <i>plus</i> Fees: \$1.50	\$90.00
3. Out-of-County Resident - (7+ credit hours system-wide); per credit hour Out-of-County Surcharge: \$186.00 (Applies only to counties with no community college.) <i>plus</i> General Tuition: \$63.50 <i>plus</i> Fees: \$1.50	\$251.00
4. Out-of-State Resident* - (including F-1 nonimmigrants - 7+ credit hours system-wide); per credit hour Out-of-State Surcharge: \$215.00 <i>plus</i> General Tuition: \$63.50 <i>plus</i> Fees: \$1.50	\$280.00
5. Unclassified Student: Out-of-State & Out-of-County* (less than 7 credit hours system-wide); per credit hour Unclassified Student Surcharge: \$25.00 <i>plus</i> General Tuition: \$63.50 <i>plus</i> Fees: \$1.50	\$90.00
6. Out-of-State students participating in Western Undergraduate Exchange Program* (any number of credit hours); per credit hour WUE Out-of-State Surcharge: \$32.50 <i>plus</i> General Tuition: \$63.50 <i>plus</i> Fees: \$1.50	\$97.50
7. Courses offered out of Arizona, including distance learning, to non-resident Out-of-State students** Total tuition per credit hour:	\$159.00
8. Corporate Tuition Rate: Out-of-State* (any number of credit hours) for out-of-state employees of companies in training contracts with Maricopa - per credit hour Out-of-State Surcharge: \$76.00 <i>plus</i> General Tuition: \$63.50 <i>plus</i> Fees: \$1.50	\$141.00
9. Skill Center Hourly Tuition Rates: Regular Rate: Nursing Assistant and Practical Nursing Programs Rate:	\$4.10 \$5.10
10. Credit by Examination and Credit by Evaluation: per credit hour (excludes HCIES courses) Regular Rate: Contract Testing Rate:	\$63.50 \$31.75

Students from the following counties are considered out-of-county and should check with their local County Board of Supervisors about out-of-county tuition and fee payments: Apache, Greenlee and Santa Cruz. Students from any other county in Arizona are considered in-county due to a reciprocal arrangement with that county.

* According to A.R.S. §15-1802F, "A person who is a member of an Indian tribe recognized by the U.S. Department of the Interior whose reservation lies in this state and extends into another state and who is a resident of the reservation is entitled to classification as an in-state student." Therefore, unclassified and out-of-state surcharges do not apply to such students.

** According to A.R.S. §15-1470, community college districts are excluded from counting as FTSE those students who reside out of the state but are taking an Arizona community college district distance learning course or a classroom-based credit course. These rates apply to out-of-state students who reside out-of-state and are taking distance learning courses or students who are taking classroom-based credit courses through a contract agreement between MCCC and the company they work for.

Special Fees

The following fees are in addition to applicable tuition and fees:

Check Returned from Bank	\$15.00
Course Materials Fee	actual cost
Distance Learning Fees	actual cost
Emergency Medical Technology (EMT)	actual cost, not to exceed \$400.00
Excessive Laboratory Breakage	actual cost
Field Studies	actual cost
Field Trips and Out-of-County/Country Tours	actual cost
Fitness Center	\$20.00
GED First Test	\$50.00
GED Test Repeat (per section)	\$10.00
Graduation Fees:	
Commencement Fee (One-time fee refundable up to two weeks prior to graduation)	\$25.00
HCIES Skills Demonstration Assessment Fee	actual cost
Health Record Student Electronic Access Fee	actual cost
HESI-PN (Health Education System): Practical Nurse for Advanced Placement	actual cost
Library Fines - List price of lost materials plus	\$5.00
NET - Nursing Entrance Test	actual cost
Nursing	
NUR111, 121, 231, 241	\$70.00
NUR117, 127, 237	\$40.00
NUR119, 129, 239, 249	\$35.00
NUR181, 281	\$30.00
NUR189, 267, 269, 289	\$25.00
NUR157	\$25.00
NCE214OP Tutored NCLEX Review	\$25.00

Admission/Registration/Enrollment

Parking Fines*:

Displaying an altered or substituted permit.....	\$50.00
Failure to register a vehicle and display a parking permit	\$30.00
Falsifying information on vehicle registration application	\$50.00
Improper display of parking permit (i.e., not affixed to window)	\$15.00
Obstructing a properly parked/moving vehicle.....	\$15.00
Parking in an unauthorized parking area	\$25.00
Parking by a college employee or student in a visitor area	\$15.00
Parking in a fire lane	\$50.00
Parking on or blocking a pedestrian path.....	\$15.00
Parking outside stall lines.....	\$15.00
Parking beyond posted time limit.....	\$15.00
Parking in an undesignated, restricted or unauthorized off-pavement area.....	\$25.00
Pulling through or backing into an angled parking space.....	\$15.00
Removing a barricade or failure to obey vehicle control device.....	\$25.00
Violating disabled parking stall or access	\$50.00

**All parking fines are doubled if not paid within 15 working days. Fees are subject to change upon adoption of the schedule for the new fiscal year. For current fee amounts, please contact College Safety.*

PED Special Course Charge.....actual cost

Private Music Lessons:

Music Majors

First 1/2 hr. per wk/per semester.....	\$0.00
Each additional 1/2 hr. per wk/per semester.....	\$90.00

Non-music Majors

First 1/2 hr. per wk/per semester.....	\$320.00
Each additional 1/2 hr. per wk/per semester.....	\$320.00

Registration Processing Fee

(assessed on a per student, per semester, per college basis)	
Refundable only if the student drops all credit classes at a particular college during the 100% refund period	\$15.00

Transcript Fee

	\$5.00
--	--------

Scottsdale Community College Specific Fees

The College may assess individual course fees, other fees, assessments, fines, or require deposits as authorized by the MCCCDC Governing Board. For current fee information, students should consult the appropriate course schedule or contact the Bursar's Office.

Students may incur expenses beyond the established fees in certain courses.

Non-Credit Courses/Seminars/Workshops/Community Services

Fees for these courses are determined by the length and type of each course and will cover total costs.

GRADUATION REQUIREMENTS

SUMMARY OF ADDITIONS AND MODIFICATIONS

This section supplements the graduation requirements in the 2006-2007 General Catalog, pages 33-72.

Arizona General Education Curriculum (AGEC) Course Matrix

Additions			
Page	Course Title and Credits	General Education Designation(s)*/Effective Term	
37	CSC283 <i>Bioinformatics and Scientific Computing</i> (3 credits)	CS/Fall 2006	
37	ENH235 <i>Survey of Gothic Literature</i> (3 credits)	HU/Fall 2006	
38	HIS254 <i>History of Ireland 1603 to the Present</i> (3 credits)	H, SB/Spring 2006	
Corrections/Modifications			
Page	Course Title and Credits	Change	General Education Designation(s)*/Effective Term
37	ECN111 <i>Macroeconomic Principles</i> (3 credits)	Course ID changing to ECN211	SB/Spring 2007
37	ECN112 <i>Microeconomic Principles</i> (3 credits)	Course ID changing to ECN212	SB/Spring 2007
37	ECN212 <i>The World Economy</i> (3 credits)	Course ID changing to ECN213	G, SB/Spring 2007
38	FON241 <i>Principles of Human Nutrition</i> AND FON241LL <i>Principles of Human Nutrition Laboratory</i> (4 credits)	Both FON241 and FON241LL must be taken.	SG/Spring 2006
38	FOR105 <i>Forensic Science: Physical Evidence</i> (4 credits)	Add SG designation	SG, SQ/Spring 2006
39	MAT216 <i>Technical Calculus I</i> (3 credits)	Course deleted	MA/Summer I 2006
39	MAT226 <i>Technical Calculus II</i> (3 credits)	Course deleted	MA/Summer I 2006
39	MAT236 <i>Technical Calculus III</i> (3 credits)	Course deleted	MA/Summer I 2006
40	WST290 <i>Women and Religion</i> (3 credits)	Add HU designation	G, HU/Retroactive to Spring 2005

Associate in Transfer Partnership (ATP) Degree

Corrections/Modifications		
Page	Section Heading	Change
57	Elements of the Associate in Transfer Partnership (ATP) Degree	Add to list of ATP degrees: <i>Elementary Education</i>

Associate in General Studies (AGS) and Associate in Applied Science (AAS) Degrees

Additions			
Page	Course Title	General Education Designation(s)*/Effective Term	
59 & 60	ASB220 <i>Archaeology Goes to the Movies</i>	HU/Fall 2006	
58 & 60	MAT213 <i>Brief Calculus</i>	MA/Fall 2006	
59 & 60	WST290 <i>Women and Religion</i>	HU/Retroactive to Spring 2005	
Corrections/Modifications			
Page	Course Title	Change	General Education Designation(s)*/Effective Term
59 & 61	FON241 <i>Principles of Human Nutrition</i> AND FON241LL <i>Principles of Human Nutrition Laboratory</i>	Both FON241 and FON241LL must be taken.	SG/Spring 2006
58 & 60	MAT216 <i>Technical Calculus I</i>	Course deleted	MA/Summer I 2006
58 & 60	MAT226 <i>Technical Calculus II</i>	Course deleted	MA/Summer I 2006
58 & 60	MAT236 <i>Technical Calculus III</i>	Course deleted	MA/Summer I 2006

Occupational Programs of Maricopa Community Colleges

Additions			
Page	Occupational Program	Maricopa Community College	
69	Retail Management and Marketing	SC	
Corrections/Modifications			
Page	Occupational Program	Change	Maricopa Community College
70	Small Business Management	Add SC	EM, SC
70	Advanced Behavioral Health Sciences	Add GC	GC, SM
70	Basic Behavioral Health	Add GC	GC, SM
71	Justice and Government Agency Administration Support Level I	Replaces <i>Justice Agencies Support Level I</i>	MC, PC
71	Justice and Government Agency Administration Level II	Replaces <i>Justice Agencies Support Level II</i>	MC, PC
71	Administration of Justice	Add PV	EM, GC, PC, PV

SCOTTSDALE COMMUNITY COLLEGE PROGRAMS

SUMMARY OF ADDITIONS AND MODIFICATIONS

This section supplements the program information in the 2006-2007 General Catalog, pages 73-116. The full text of additions and changes to college programs follows this summary.

New Associate of Applied Science (AAS) Degrees		New Certificates of Completion (CCL) Effective Fall 2006	
Page	Program Title	Page	Program Title
86	Culinary Fundamentals - Effective Fall 2006	86	Culinary Fundamentals
94	Strength, Nutrition and Personal Training (Shared: CGCC, EMCC, GCC, GWCC, MCC, PC, PVCC, SCC, SMCC) - Effective Summer I 2006	99	Hospitality and Tourism/Spa and Wellness Center Management
Program Modifications Effective Fall 2006		Program Elements Modified	
Page	Program Title	Page	Program Elements Modified
86	Culinary Arts - CCL		Admission criteria, required courses, and competencies.
86	Culinary Arts - AAS		Admission criteria, required courses, and competencies.
88	Dance Technology – CCL		Required courses, restricted electives, and competencies.
88	Dance Technology – AAS		Required courses, restricted electives, and competencies.
91	Equine Science - CCL		Description, required courses, restricted electives, and competencies.
91	Equine Science - AAS		Description, required courses, restricted electives, and competencies.
108	Audio Production Technologies – CCL (Shared: GCC, MCC, PC, PVCC, SCC)		Required courses, total program credits and competencies.
108	Audio Production Technologies – AAS (Shared: GCC, MCC, PC, PVCC, SCC)		Required courses, total program credits and competencies.
109	Nursing – AAS (Shared: CGCC, GCC, GWCC, MCC, PC, PVCC, RSC, SCC)		Addition of Estrella Mountain Community College as a participating college for the Associate in Applied Science degree only.

CCL = Certificate of Completion
 AAS = Associate in Applied Science Degree

Programs

New Programs

CULINARY ARTS

Hospitality, Tourism, and Culinary Arts
 Division Office AP 253 (480) 423-6578
 Program Director, Karen Chalmers AP 254 (480) 423-6241

CERTIFICATE OF COMPLETION IN CULINARY FUNDAMENTALS: 16 credits

The program provides instruction in culinary concepts and terminology, kitchen safety and sanitation, equipment usage, basic nutritional guidelines, standard and metric measurements, food costing, and theory and practice in the production of culinary products. Courses emphasize fundamental cooking techniques and preparation methods for hot foods, breakfast items, salads, sandwiches, dressings, breads and pastries.

REQUIRED COURSES: 16 credits

CUL101 Culinary Fundamentals: Culinary Basics4
 CUL102 Culinary Fundamentals: Hot Foods4
 CUL103 Culinary Fundamentals: Breakfast and Garde Manger4
 CUL104 Culinary Fundamentals: Bakery and Pastry4

Grade of "C" or better required for all courses in the Certificate of Completion in Culinary Fundamentals.

AAS IN CULINARY FUNDAMENTALS: 60 credits

The Associate in Applied Science will provide students instruction in cooking fundamentals, which can assist them with advancement in a current job in culinary arts or with entry into the industry. It is designed to serve those individuals that are employed full-time who desire to change careers and those who wish to develop skills to transition into cooking within the hospitality industry. It will also serve any student who would like to enter the culinary arts industry whose schedule does not permit attending a block certificate program.

REQUIRED COURSES: 16 credits

CUL101 Culinary Fundamentals: Culinary Basics4
 CUL102 Culinary Fundamentals: Hot Foods4
 CUL103 Culinary Fundamentals: Breakfast and Garde Manger4
 CUL104 Culinary Fundamentals: Bakery and Pastry4

RESTRICTED ELECTIVES: 17-19 credits

ACC++++ Any Accounting courses
 CUL++++ Any Culinary courses
 HRM++++ Any Hospitality and Tourism Management courses
 IBS++++ Any International Business courses
 MGT++++ Any Management courses
 MKT++++ Any Marketing courses
 SBS++++ Any Small Business Management courses

GENERAL EDUCATION (G.E.) REQUIREMENTS: 25-27 credits

CORE: 15-17 credits

First-Year Composition

ENG101 First-Year Composition (3) OR
 ENG107 First-Year Composition for ESL (3) AND
 ENG102 First-Year Composition (3) OR
 ENG108 First-Year Composition for ESL (3)6

Oral Communication

Any approved G. E. course from the Oral Communication area3

Critical Reading

CRE101 Critical and Evaluative Reading I (3) OR
 equivalent as indicated3

Mathematics

Any approved G. E. course from the Mathematics area 3-5

DISTRIBUTION: 10 credits

Humanities and Fine Arts

Any approved G. E. course from the Humanities and Fine Arts area3

Natural Sciences

Any approved G. E. course from the Natural Sciences area4

Social and Behavioral Sciences

Any approved G. E. course from the Social/Behavioral Sciences area3

Grade of "C" or better required for all courses in the AAS in Culinary Fundamentals.

CUL

FITNESS/NUTRITION

FON, HES, PED

HPERD Division Office PE 155 (480) 423-6606
 Program Contact, Amy Goff PE 148 (480) 423-6685

This program prepares students with the knowledge and experience required to be eligible for the American College of Sports Medicine (ACSM) Health and Fitness Instructor Certification, ACSM personal trainer certification, the National Strength and Conditioning Association (NSCA) personal trainer certification, and the American Council on Exercise (ACE) personal trainer certification. This degree will provide students with a stronger educational background making them more marketable in the field of fitness and nutrition. This degree will also meet the needs of individuals with existing degrees in such fields as Exercise Physiology, Nutrition, Athletic Training and other health related disciplines. Registered dietitians, clinical exercise physiologists, personal trainers, exercise specialists, strength and conditioning specialists, coaches, athletes and others interested in acquiring knowledge in exercise, nutrition and health are also eligible for this program.

ASSOCIATE IN APPLIED SCIENCE IN STRENGTH, NUTRITION AND PERSONAL TRAINING: 72-75 credits

REQUIRED COURSES: 47-48 credits

BPC110 Computer Usage and Applications3
 FON100 Introductory Nutrition3
 FON100AD Nutrition Sports and Physical Activity1
 FON137 Nutrition Supplements2
 FON230 Nutrition for Special Populations3
 FON247 Weight Management Theory3
 MGT253 Owning and Operating a Small Business3
 HES154 First Aid/Cardiopulmonary Resuscitation (3) OR
 BLS Health Care Provider and First Aid Certification3
 HES271 Prevention and Treatment of Athletic Injuries3
 PED112 Professional Applications of Fitness Principles3
 PED125 Exercise Science3
 PED135++ Practical Applications of Personal Training Skills and
 Techniques Internship (3) OR
 PED285 Exercise Program Design and Instruction (3)3
 PED145 Guidelines for Exercise Testing and Prescription3
 PSY101 Introduction to Psychology3
 PSY215 Introduction to Sport Psychology3

AND

Choose one of the following series for 5-6 credits:

Series 1: Credits: 6

PED212SC Instructional Comp. Lab: Muscular Strength/Conditioning2
 PED212CR Instructional Comp. Lab: Cardioresp. Exercises/Activities2
 PED212FL Instructional Comp. Lab: Flexibility/Mind-Body Exercises2

OR

Series 2: Credits: 5

PED130 Strength Fitness-Phys. Principles and Training Techniques3
 PED132 Cardio. Fitness: Phys. Principles and Training Techniques2

OR

Series 3: Credits: 5

PED275 Methods of Enhancing Physical Performance3
 PED132 Cardio. Fitness: Phys. Principles and Training Techniques2

Continued next page...

Scottsdale Community College Programs

GENERAL EDUCATION (G.E.) REQUIREMENTS: 25-27 credits

CORE: 15-17 credits

First-Year Composition

Any approved G. E. courses from the First-Year Composition area6

Oral Communication

COM100 Introduction to Human Communication (3) OR

COM110 Interpersonal Communication (3)3

Critical Reading

CRE101 Critical and Evaluative Reading I (3) OR

Equivalent as indicated.....3

Mathematics

MAT120 Intermediate Algebra (5) OR

MAT121 Intermediate Algebra (4) OR

MAT122 Intermediate Algebra (3)3-5

DISTRIBUTION: 10 credits

Humanities and Fine Arts

Any approved G. E. course from the Humanities and Fine Arts area.....3

Natural Sciences

BIO160 Introduction to Human Anatomy and Physiology4

Social and Behavioral Sciences

CFS205 Human Development (3) OR

HES100 Healthful Living (3)3

Grade of "C" or better required for all courses in the AAS in Strength, Nutrition and Personal Training.

HOSPITALITY AND TOURISM/ SPA AND WELLNESS CENTER MANAGEMENT

HRM

Hospitality, Tourism, and Culinary Arts

Division Office AP 253 (480) 423-6578

Program Director, Larry Williams AP 244 (480) 423-6266

The Hospitality and Tourism/Spa and Wellness Center Management program is designed to prepare graduates for management careers in spa and wellness center management. The program provides an industry specific business foundation combined with an overview of healthful living courses with specific application to spa and wellness center management. Graduates acquire a specific mix of skills that are in high demand with employers in a newly developing, rapid-growth segment of the hospitality industry. The hospitality industry is among the largest and fastest growing in the world, offering opportunities for ambitious students who enjoy working with people.

CERTIFICATE OF COMPLETION IN HOSPITALITY AND TOURISM/SPA AND WELLNESS CENTER MANAGEMENT: 42 credits

REQUIRED COURSES: 36 credits

ACC211 Financial Accounting.....3

HES100 Healthful Living.....3

HES154 First Aid/Cardiopulmonary Resuscitation3

HRM110 Introduction to Hospitality and Tourism Management.....3

HRM130 Guest Services Management3

HRM150 Hospitality and Tourism Information Systems I.....3

HRM220 Hospitality Managerial Accounting.....3

HRM260 Hospitality Human Resource Management.....3

HRM270 Hospitality Marketing3

HRM280 Hospitality and Tourism Law3

HRM/PED296WC Cooperative Education.....3

WED162 Meditation and Wellness1

WED165 Overview of Massage Therapy2

RESTRICTED ELECTIVES: 6 credits

HRM145 Events Management3

HRM235 Club Management.....3

HRM250 Hospitality and Tourism Information Systems II.....3

HRM290 Ecotourism.....3

HRM291 Directed Field Study - International.....3

PED101YJ Physical Activities: Yoga (1) OR

PED102YJ Physical Activities: Yoga (1) OR

PED201YJ Physical Activities: Yoga (1) OR

PED202YJ Physical Activities: Yoga (1)3

PED101VR Physical Activities: Tai Chi (1) OR

PED102VR Physical Activities: Tai Chi (1) OR

PED201VR Physical Activities: Tai Chi (1) OR

PED202VR Physical Activities: Tai Chi (1)3

PED112 Professional Application of Fitness Principles.....3

PED116 Aerobics for Wellness2

PED/WED130 Strength Fitness-Phys. Principles and Training Techniques3

WED151 Introduction to Alternative Medicine.....3

WED172 Overview of Herbal Remedies1

WED195AA Special Topics in Wellness Education.....0.5

WED195AB Special Topics in Wellness Education.....1

WED195AC Special Topics in Wellness Education.....2

WED218 Aromatherapy1

Grade of "C" or better required for all courses in the CCL in Hospitality and Tourism/Spa and Wellness Center Management.

Programs

Program Modifications

CULINARY ARTS

Hospitality, Tourism, and Culinary Arts
 Division Office AP 253 (480) 423-6578
 Program Director, Karen Chalmers AP 254 (480) 423-6241

The Culinary Arts Program offers multiple certificate and AAS courses of study for students. Further information on all programs may be obtained by calling the Culinary Arts office (480-423-6241), the division office (480-423-6578), or by visiting the website at www.scottsdalecc.edu/culinary. The program is proud to be accredited by the American Culinary Federation.

Culinary Block Program

The Block Certificate Program accepts 36 students each semester through an application and interview process. Interested students are encouraged to apply well in advance of their intended semester of enrollment. A lab fee of \$475.00 is required upon acceptance.

Advanced Professional Culinary Arts Courses

Advanced Professional Culinary Arts courses are designed to enhance and refine the skills of current employees in the culinary industry, as well as graduates from basic culinary certificate programs. Instruction is provided in intensive, hands-on formats, emphasizing specialized techniques in each course area. NOTE: All classes in the advanced program require students to have a kitchen uniform consisting of a chef's coat, chef's pants, kitchen apron and standard knives and tools.

CERTIFICATE OF COMPLETION IN CULINARY ARTS: 34 credits

ADMISSION CRITERIA:

Formal application and admission to the program is required. A special fee of \$475 is required each semester in addition to the regular tuition fees. Placement into 100-level English, reading and math classes on the ASSET test, or completion of equivalent coursework.

REQUIRED COURSES: 34 credits

CUL115	Food Service Sanitation, Safety and Stewarding.....	2
CUL120	Food Costing, Purchasing and Inventory Control.....	2
CUL130	Hot Foods I.....	3
CUL140	Culinary Principles and Kitchen Management I.....	3
CUL150	Garde Manger I.....	2
CUL160	Bakery and Pastry Production I.....	3
CUL170	Dining Room Operations I.....	2
CUL210	Menu Planning and Facilities Design.....	2
CUL220	Food Service Nutrition.....	2
CUL230	Hot Foods II.....	3
CUL240	Culinary Principles and Kitchen Management II.....	3
CUL250	Garde Manger II.....	2
CUL260	Bakery and Pastry Production II.....	2
CUL270	Dining Room Operations II.....	3

Grade of "C" or better required for all courses in the Certificate of Completion in Culinary Arts.

CUL

AAS IN CULINARY ARTS: 65-67 credits

ADMISSION CRITERIA:

Formal application and admission to the program is required. A special fee of \$475 is required each semester in addition to the regular tuition fees. Placement into 100-level English, reading and math classes on the ASSET test, or completion of equivalent coursework.

REQUIRED COURSES: 34 credits

CUL115	Food Service Sanitation, Safety and Stewarding.....	2
CUL120	Food Costing, Purchasing and Inventory Control.....	2
CUL130	Hot Foods I.....	3
CUL140	Culinary Principles and Kitchen Management I.....	3
CUL150	Garde Manger I.....	2
CUL160	Bakery and Pastry Production I.....	3
CUL170	Dining Room Operations I.....	2
CUL210	Menu Planning and Facilities Design.....	2
CUL220	Food Service Nutrition.....	2
CUL230	Hot Foods II.....	3
CUL240	Culinary Principles and Kitchen Management II.....	3
CUL250	Garde Manger II.....	2
CUL260	Bakery and Pastry Production II.....	2
CUL270	Dining Room Operations II.....	3

RESTRICTED ELECTIVES: 6 credits

CUL180	Food in History.....	3
CUL190	Catering Operations I.....	3
CUL235	Advanced Culinary Techniques I - Meats.....	2
CUL236	Advanced Culinary Techniques II - Seafood.....	2
CUL237	Advanced Culinary Techniques III - Game and Poultry.....	2
CUL245	Professional Kitchen Management Techniques.....	2
CUL255	Advanced Garde Manger I - Salads and Sandwiches.....	2
CUL256	Advanced Garde Manger II - Appetizers and Hors d'Oeuvres.....	2
CUL265	Professional Baking I - Base Products and Sauces.....	2
CUL266	Professional Baking II - Breads and Rolls.....	2
CUL267	Professional Baking III - Pastries, Pies and Cakes.....	2
CUL268	Professional Baking IV - Decorative and Design Work.....	2
CUL296++	Cooperative Education (any module).....	1-4
CUL298++	Special Projects (any module).....	1-3
HRM110	Introduction to Hospitality and Tourism Management.....	3
HRM150	Hospitality and Tourism Information Systems I.....	3
HRM230	Beverage Management.....	3
HRM275	Restaurant Management.....	3
HRM280	Hospitality and Tourism Law.....	3

GENERAL EDUCATION (G.E.) REQUIREMENTS: 25-27 credits

CORE: 15-17 credits

First-Year Composition

ENG101	First-Year Composition (3) OR	
ENG107	First-Year Composition for ESL (3) AND	
ENG102	First-Year Composition (3) OR	
ENG108	First-Year Composition for ESL (3).....	6

Oral Communication

Any approved G.E. course from the Oral Communication area.....3

Critical Reading

CRE101 Critical and Evaluative Reading I (3) OR
 equivalent as indicated.....3

Mathematics

Any approved G. E. course from the Mathematics area..... 3-5

DISTRIBUTION: 10 credits

Humanities and Fine Arts

Any approved G. E. course from the Humanities and Fine Arts area.....3

Natural Sciences

Any approved G. E. course from the Natural Sciences area.....4

Social and Behavioral Sciences

Any approved G. E. course from the Social/Behavioral Sciences area.....3

Grade of "C" or better required for all courses in the AAS in Culinary Arts.

Scottsdale Community College Programs

DANCE TECHNOLOGY

HPERD Division OfficePE 155(480) 423-6606

The Dance Technology Program is designed for students who plan to enter the field of dance as performers, choreographers, teachers and dance technologists. Students will study dance theory, performance and production. They will receive hands-on training in multimedia production and the application of video and computer technology to dance.

CERTIFICATE OF COMPLETION IN DANCE TECHNOLOGY: 40-44 credits

PROGRAM NOTE: Students must enroll in one Ballet or Modern Dance technique class each semester.

REQUIRED COURSES: 31-35 credits

ADA/ART177	Computer-Photographic Imaging	3
DAH100	Introduction to Dance	3
DAN131	Ballet I (1) OR	
DAN134	Ballet II (1) OR	
DAN231AA	Ballet III: Intensive (2) OR	
DAN234AA	Ballet IV: Intensive (2)	2-4
DAN132	Modern Dance I (1) OR	
DAN135	Modern Dance II (1) OR	
DAN232	Modern Dance III (1) OR	
DAN235	Modern Dance IV (1) OR	
DAN232AA	Modern Dance III: Intensive (2) OR	
DAN235AA	Modern Dance IV: Intensive (2)	2-4
DAN210	Dance Production I	3
DAN221	Rhythmic Theory for Dance I	2
DAN264	Choreography I	3
DAN267	Dance for Children	3
DAN272	Dance Technology	2
DAN280	Dance Practicum	2
MTC191	Electronic Music I	3
TCM100	Digital Multi Media	3
RESTRICTED ELECTIVES: 9 credits		
ADA/ART175	Electronic Publishing Design I	3
ART100	Introduction to Computer Graphic Art	1
ART131	Photography I	3
ART150	Digital Storytelling (COM150/STO150)	3
DAH110	Dance in Film	3
DAH201	World Dance Perspectives	3
DAN120++	World Dance (any modules)	1-2
DAN133	Modern Jazz Dance I (1) OR	
DAN136	Modern Jazz Dance II (1) OR	
DAN233	Modern Jazz Dance III (1) OR	
DAN236	Modern Jazz Dance IV (1)	1
DAN138	Dance Seminar I	1
DAN140	Tap Dance I	1
DAN150	Dance Performance I	1-2
DAN211	Dance Production II	3
DAN233AA	Modern Jazz Dance III: Intensive (2) OR	
DAN236AA	Modern Jazz Dance IV: Intensive (2)	2
DAN238	Dance Seminar II	1
DAN241	Dance Notation I	3
DAN/MUP285++	Multimedia Performance Ensemble (any module)	3
MKT210	Applied Marketing Strategies	3
TCM134	Pre-Production for Motion Picture and Television	3
TCM135	Production for Motion Picture and Television	3
TCM136	Post-Production for Motion Picture and Television	3

Grade of "C" or better required for all courses in the Certificate of Completion in Dance Technology.

DAN

AAS IN DANCE TECHNOLOGY: 62-68 credits

PROGRAM NOTE: Students must enroll in one Ballet or Modern Dance technique class each semester.

REQUIRED COURSES: 31-35 credits

ADA/ART177	Computer-Photographic Imaging	3
DAH100	Introduction to Dance	3
DAN131	Ballet I (1) OR	
DAN134	Ballet II (1) OR	
DAN231AA	Ballet III: Intensive (2) OR	
DAN234AA	Ballet IV: Intensive (2)	2-4
DAN132	Modern Dance I (1) OR	
DAN135	Modern Dance II (1) OR	
DAN232	Modern Dance III (1) OR	
DAN235	Modern Dance IV (1) OR	
DAN232AA	Modern Dance III: Intensive (2) OR	
DAN235AA	Modern Dance IV: Intensive (2)	2-4
DAN210	Dance Production I	3
DAN221	Rhythmic Theory for Dance I	2
DAN264	Choreography I	3
DAN267	Dance for Children	3
DAN272	Dance Technology	2
DAN280	Dance Practicum	2
MTC191	Electronic Music I	3
TCM100	Digital Multi Media	3
RESTRICTED ELECTIVES: 9 credits		
ADA/ART175	Electronic Publishing Design I	3
ART100	Introduction to Computer Graphic Art	1
ART131	Photography I	3
ART150	Digital Storytelling (COM150/STO150)	3
DAH110	Dance in Film	3
DAH201	World Dance Perspectives	3
DAN120++	World Dance (any modules)	1-2
DAN133	Modern Jazz Dance I (1) OR	
DAN136	Modern Jazz Dance II (1) OR	
DAN233	Modern Jazz Dance III (1) OR	
DAN236	Modern Jazz Dance IV (1)	1
DAN138	Dance Seminar I	1
DAN140	Tap Dance I	1
DAN150	Dance Performance I	1-2
DAN211	Dance Production II	3
DAN233AA	Modern Jazz Dance III: Intensive (2) OR	
DAN236AA	Modern Jazz Dance IV: Intensive (2)	2
DAN238	Dance Seminar II	1
DAN241	Dance Notation I	3
DAN/MUP285++	Multimedia Performance Ensemble (any module)	3
MKT210	Applied Marketing Strategies	3
TCM134	Pre-Production for Motion Picture and Television	3
TCM135	Production for Motion Picture and Television	3
TCM136	Post-Production for Motion Picture and Television	3

Continued next page...

Scottsdale Community College Programs

GENERAL EDUCATION (G.E.) REQUIREMENTS: 22-24 credits

CORE: 15-17 credits

First-Year Composition

ENG101	First-Year Composition (3) OR	
ENG107	First-Year Composition for ESL (3) AND	
ENG102	First-Year Composition (3) OR	
ENG108	First-Year Composition for ESL (3)	6

Oral Communication

Any approved G. E. course from the Oral Communication area 3

Critical Reading

CRE101 Critical and Evaluative Reading I (3) OR
equivalent as indicated by assessment. 3

Mathematics

Any approved G. E. course from the Mathematics area 3-5

DISTRIBUTION: 7 credits

Humanities and Fine Arts

Met by DAH100 listed in the Required Courses area 0

Natural Sciences

Any approved G. E. course from the Natural Sciences area 4

Social and Behavioral Sciences

Any approved G. E. course from the Social/Behavioral Sciences area 3

Grade of "C" or better required for all courses in the AAS in Dance Technology.

EQUINE SCIENCE

EQS

Applied Sciences Division Office AP 237B (480) 423-6599
Program Director, Diane Blazer AP 229 (480) 423-6231

The Equine Science program is designed to offer a broad-based educational background for students who wish to enter the horse industry job market or transfer to a four-year equine science program. An Associate in Applied Science (AAS) in Equine Science will be awarded upon satisfactory completion of the outlined program. A Certificate of Completion in Equine Science is also offered. Community participants may enroll in individual classes with a Pass/Fail grade option, if desired.

CERTIFICATE OF COMPLETION IN EQUINE SCIENCE: 42 credits

REQUIRED COURSES: 36 credits

BPC110	Computer Usage and Applications (3) OR	
CIS105	Survey of Computer Information Systems (3)	3
EQS105	Principles of Equine Science	3
EQS120	Equine Anatomy and Physiology	3
EQS130	Equine Business and Law	3
EQS140	Equine Behavior	3
EQS200	Principles of Equine Nutrition	3
EQS215	Feeding Programs for Production and Performance	3
EQS220	Equine Reproduction	3
EQS225	Equine Health and Disease Management	3
EQS250	Equine Evaluation	3
EQS280	Equine Science Internship	2
EQS282	Special Event Internship	1
MGT253	Owning and Operating a Small Business	3

RESTRICTED ELECTIVES: 6 credits

EQS175	Introduction to Equine Massage	3
EQS235	English Horsemanship and Training	3
EQS245	Western Horsemanship and Training	3
EQS280	Equine Science Internship	2
EQS282	Special Event Internship (1)	1-3
MGT251	Human Relations in Business	3
MKT101	Introduction to Public Relations	3
MKT263	Advertising Principles	3
PSY250	Social Psychology	3
SPA115	Beginning Spanish Conversation I	3

Grade of "C" or better required for all courses in the Certificate of Completion in Equine Science.

AAS IN EQUINE SCIENCE: 67-69 credits

REQUIRED COURSES: 36 credits

BPC110	Computer Usage and Applications (3) OR	
CIS105	Survey of Computer Information Systems (3)	3
EQS105	Principles of Equine Science	3
EQS120	Equine Anatomy and Physiology	3
EQS130	Equine Business and Law	3
EQS140	Equine Behavior	3
EQS200	Principles of Equine Nutrition	3
EQS215	Feeding Programs for Production and Performance	3
EQS220	Equine Reproduction	3
EQS225	Equine Health and Disease Management	3
EQS250	Equine Evaluation	3
EQS280	Equine Science Internship	2
EQS282	Special Event Internship	1
MGT253	Owning and Operating a Small Business	3

RESTRICTED ELECTIVES: 6 credits

EQS175	Introduction to Equine Massage	3
EQS235	English Horsemanship and Training	3
EQS245	Western Horsemanship and Training	3
EQS280	Equine Science Internship	2
EQS282	Special Event Internship (1)	1-3
MGT251	Human Relations in Business	3
MKT101	Introduction to Public Relations	3
MKT263	Advertising Principles	3
PSY250	Social Psychology	3
SPA115	Beginning Spanish Conversation I	3

GENERAL EDUCATION (G.E.) REQUIREMENTS: 25-27 credits

CORE: 15-17 credits

First-Year Composition

ENG101	First-Year Composition (3) OR	
ENG107	First-Year Composition for ESL (3) AND	
ENG102	First-Year Composition (3) OR	
ENG108	First-Year Composition for ESL (3)	6

Oral Communication

Any approved G. E. course from the Oral Communication area 3

Critical Reading

CRE101 Critical and Evaluative Reading I (3) OR
equivalent as indicated by assessment. 3

Mathematics

Any approved G. E. course from the Mathematics area 3-5

DISTRIBUTION: 10 credits

Humanities and Fine Arts

Any approved G. E. course from the Humanities and Fine Arts area 3

Natural Sciences

Any approved G. E. course from the Natural Sciences area 4

Social and Behavioral Sciences

PSY101 Introduction to Psychology 3

Grade of "C" or better required for all courses in the AAS in Equine Science.

Scottsdale Community College Programs

MUSIC

Music Department MB 144 (480) 423-6333

Two certificate/degree programs offer students an opportunity to receive training in the commercial music business. Through the Audio Production Technologies program, students will receive training on industry-standard equipment by instructors with real-world experience and professional resumes. The Music Business program is designed to prepare students for today's music industry, combining a flexible curriculum with an emphasis in business and marketing, along with music industry-related courses.

CERTIFICATE OF COMPLETION IN AUDIO PRODUCTION TECHNOLOGIES: 39 credits

REQUIRED COURSES: 39 credits

MTC101	Introduction to Music Theory.....	3
MTC103	Introduction to Aural Perception	2
MTC180	Computer Literacy for Musicians (3) OR	
MUC295	Studio Music Recording III (3)	3
MTC191	Electronic Music I.....	3
MTC192	Electronic Music II.....	3
MUC109	Music Business: Merchandising and the Law.....	3
MUC110	Music Business: Recording and Mass Media.....	3
MUC111	Digital Audio Workstation I (DAW I).....	3
MUC112	Digital Audio Workstation II (DAW II).....	3
MUC195	Studio Music Recording I (3) OR	
MUC195AA	Studio Music Recording I (3).....	3
MUC196	Studio Music Recording II.....	3
MUC197	Live Sound Reinforcement I.....	3
MUC198	Live Sound Reinforcement II	3
MUC297AA	Music Internship	1

Grade of "C" or better required for all courses in the Certificate of Completion in Audio Production Technologies.

AAS IN AUDIO PRODUCTION TECHNOLOGIES: 67 credits

REQUIRED COURSES: 39 credits

MTC101	Introduction to Music Theory.....	3
MTC103	Introduction to Aural Perception	2
MTC180	Computer Literacy for Musicians (3) OR	
MUC295	Studio Music Recording III (3)	3
MTC191	Electronic Music I.....	3
MTC192	Electronic Music II.....	3
MUC109	Music Business: Merchandising and the Law.....	3
MUC110	Music Business: Recording and Mass Media.....	3
MUC111	Digital Audio Workstation I (DAW I).....	3
MUC112	Digital Audio Workstation II (DAW II).....	3
MUC195	Studio Music Recording I (3) OR	
MUC195AA	Studio Music Recording I (3).....	3
MUC196	Studio Music Recording II.....	3
MUC197	Live Sound Reinforcement I.....	3
MUC198	Live Sound Reinforcement II	3
MUC297AA	Music Internship	1

GENERAL EDUCATION (G.E.) REQUIREMENTS: 28 credits

CORE: 15 credits

First-Year Composition

Any approved G. E. courses from the First-Year Composition area 6

Oral Communication

Any approved G. E. course from the Oral Communication area 3

Critical Reading

CRE101	Critical and Evaluative Reading I (3) OR	
	Equivalent by assessment.....	3

MTC, MUC

Mathematics

Any approved G. E. course from the Mathematics area 3

DISTRIBUTION: 13 credits

Humanities and Fine Arts

Any approved G. E. courses from the Humanities and Fine Arts area 6

Note: MHL140 or MHL145 or MHL153 recommended.

Natural Sciences

Any approved G. E. course from the Natural Sciences area 4

Social and Behavioral Sciences

Any approved G. E. course from the Social/Behavioral Sciences area 3

Grade of "C" or better required for all courses in the AAS in Audio Production Technologies.

NURSING SCIENCE

NUR

Health Sciences Division Office SB 132 (480) 423-6225

The Nursing Program is available at nine of the Maricopa Community Colleges. The nursing pathway provides multiple exit points for employment that begins with the Nurse Assisting course and continues to the Practical Nurse certificate and Registered Nurse degree program. The Nursing Program provides eligibility for students seeking certification and licensure through the Arizona State Board of Nursing. Licensing requirements are the exclusive responsibility of the Arizona State Board of Nursing.

The Nursing Program is approved by the Arizona State Board of Nursing and accredited by the National League for Nursing Accrediting Commission (NLNAC), 61 Broadway 33rd Floor, New York, New York 10006, 212.363.5555, ext. 153.

Program Offerings:

This program is offered at the following sites:

Chandler Gilbert Community College	480-988-8880
Estrella Mountain Community College.....	623-935-8953
GateWay Community College.....	602-286-8686
Glendale Community College	623-845-3210
Mesa Community College.....	480-461-7106
Mesa Community College/Boswell.....	623-974-7835
Paradise Valley Community College.....	602-787-7284
Phoenix College	602-285-7110
Rio Salado College.....	480-517-8580
Scottsdale Community College.....	480-423-6225

**All other information for the Nursing Program in the
2006-2007 college catalog remains the same.**

COURSE DESCRIPTIONS

SUMMARY OF ADDITIONS AND MODIFICATIONS

This section supplements the course information in the 2006-2007 General Catalog, pages 118-206. The full text of new and modified courses follows this summary.

New Courses Effective Fall 2006		
Course		Page
CUL101	<i>Culinary Fundamentals: Culinary Basics</i>	145
CUL102	<i>Culinary Fundamentals: Hot Foods</i>	145
CUL103	<i>Culinary Fundamentals: Breakfast and Garde Manger</i>	145
CUL104	<i>Culinary Fundamentals: Bakery and Pastry</i>	145
EQS235	<i>English Horsemanship and Training</i>	165
EQS245	<i>Western Horsemanship and Training</i>	165
FOR106	<i>Forensic Science: Biological Evidence</i>	167
TCM222	<i>DVD Authoring</i>	186
TCM290	<i>Professional Media Marketing</i>	187
Course Modifications Effective Summer 2006		
Course	Course Elements Modified	Page
CIS233AC	<i>Internet Web Publishing: Dreamweaver Level I</i> Title, description, and prerequisites	140
Course Modifications Effective Fall 2006		
Course	Course Elements Modified	Page
AJS101	<i>Introduction to Criminal Justice</i> Description	118
ART234	<i>Color Photography I</i> Description, prerequisites, and course note	126
ART290AC	<i>Studio Art</i> Course ID formerly ART290; addition of two suffixed courses ART290AA (1 credit) and ART290AB (2 credits); prerequisites and course note	128
CHM150	<i>General Chemistry I</i> Prerequisites	134
CHM151	<i>General Chemistry I</i> Prerequisites	134
CHM151LL	<i>General Chemistry I Laboratory</i> Prerequisites	134
CHM152	<i>General Chemistry II</i> Prerequisites	134
CHM154	<i>General Chemistry II with Qualitative Analysis</i> Prerequisites	134
CHM230	<i>Fundamental Organic Chemistry</i> Prerequisites	134
CHM235	<i>General Organic Chemistry I</i> Prerequisites	134
CHM236	<i>General Organic Chemistry IIA</i> Prerequisites	134
CIS250	<i>Management Information Systems</i> Title, description, and prerequisites	141
CUL120	<i>Food Costing, Purchasing and Inventory Control</i> Course ID formerly CUL126	145
CUL220	<i>Food Service Nutrition</i> Course ID formerly CUL110	145
ENG107	<i>First-Year Composition for ESL</i> Description	162
ENG108	<i>First-Year Composition for ESL</i> Description	162
EPD247	<i>Practicum for English as a Second Language (ESL)/ Bilingual Teachers</i> Prerequisites	154
EQS280	<i>Equine Science Internship</i> Course note	165
GBS221	<i>Business Statistics</i> Description and prerequisites	131
PSY277	<i>Psychology of Human Sexuality</i> Description	199
SOC140	<i>Racial and Ethnic Minorities</i> Description	202
TCM215	<i>Cinematography</i> Description	185
TCM245	<i>Advanced Motion Picture Production</i> Course note	186
TCM250	<i>Documentaries for Social Change</i> Course note	186
TCM271	<i>Advanced Non-Linear Effects and Compositing</i> Addition of two suffixed courses (TCM271AA and TCM271AB)	186
Course Modifications Effective Spring 2007		
Course	Course Elements Modified	Page
ECN211	<i>Macroeconomic Principles</i> Course ID formerly ECN111	151
ECN212	<i>Microeconomic Principles</i> Course ID formerly ECN112	151
EPD275	<i>Diagnosis and Remediation of Reading K-12</i> Course prefix formerly EDU	153/154
EPD279	<i>Reading Practicum K-12</i> Course prefix formerly EDU	153/154
FSC110	<i>Wildland Firefighter</i> Credits, periods, and load	166
MAT220	<i>Analytic Geometry and Calculus I</i> Title and description	182
MAT230	<i>Analytic Geometry and Calculus II</i> Title and description	182
MAT240	<i>Calculus with Analytic Geometry III</i> Description and course note	182
MAT241	<i>Calculus with Analytic Geometry III</i> Description and course note	182
TCM240	<i>Advanced Television Production</i> Title, description, and prerequisites	186
TCM242	<i>Portfolio Non-linear Editing</i> Periods and load	186
TCM260	<i>Film/Video Producing and Financing</i> Activity type, periods, and load	186
TCM280	<i>The Art of Editing</i> Description	186

New Courses

The following are new courses effective Fall 2006:

CULINARY ARTS

Hospitality, Tourism and Culinary Arts

Division Office AP 253.....(480) 423-6578

CUL

CUL101 4 credits 4 periods

Culinary Fundamentals: Culinary Basics

Theory and practice of basic elements of culinary arts fundamentals. Emphasis on safety, sanitation and uniform requirements, culinary terminology, basic nutritional guidelines, equipment needs and usage, standard measurements, knife selection and care, basic knife cuts, and fruit and vegetable identification and preparation. Prerequisites: None.

CUL102 4 credits 4 periods

Culinary Fundamentals: Hot Foods

Cooking techniques and preparation of varied meat, fish and poultry items. Theory and practice of production of stocks, sauces and soups. Study of butchering, yields, purchasing and grade classification. Prerequisites: None.

CUL103 4 credits 4 periods

Culinary Fundamentals: Breakfast and Garde Manger

Cooking techniques and preparation of breakfast items, salads, sandwiches, and dressings. Theory and practice of production of egg, pasta, cheeses, and fruit dishes, canapes and hors d'oeuvre creations. Study of lettuces, fruits, grains, cheeses and dressings as components of salads and sandwiches. Prerequisites: None.

CUL104 4 credits 4 periods

Culinary Fundamentals: Bakery and Pastry

Provides a study of cooking techniques and preparation methods for cakes, pies, cookies and simple desserts as well as production of doughs and breads. Includes preparation of various bakery sauces and toppings, uses of chocolate, and appropriate presentation methods for various types of desserts. Prerequisites: None.

EQUINE SCIENCE

Applied Sciences Division Office AP 237B.....(480) 423-6599

EQS

EQS235 3 credits 3 periods

English Horsemanship and Training

Riding skills and training techniques for the English horse. Includes review of basic horsemanship skills, lateral bend and vertical flexion, halt, rein back, leg yield, counter canter, simple and flying change of leads, mental preparation for shows and the judging criteria for various performances. Prerequisites: None.

EQS245 3 credits 3 periods

Western Horsemanship and Training

Riding skills and training techniques for the western horse. Includes review of basic horsemanship skills, stopping, backing, two track, simple and flying lead changes, turns on the forehand and hindquarters, rating speed collection, western riding patterns and horse show preparation. Prerequisites: None.

FORENSIC SCIENCE

FOR

Applied Sciences Division Office AP 237B.....(480) 423-6599

FOR106 4 credits 6 periods

Forensic Science: Biological Evidence

Scientific analysis and examination of biological evidence for forensic purposes. Covers blood, bloodstains, other biological fluids and stains, hair, DNA, toxicological evidence, controlled substances and alcohol. Includes the history of forensic science, functions of the crime lab, and criminalist career specialties. Prerequisites: None.

MOTION PICTURE/TELEVISION PRODUCTION TCM

MP/TV Department Office..... LC 305.....(480) 423-6076

Fine Arts Division Office..... MB 139.....(480) 423-6328

TCM222 4 credits 6 periods

DVD Authoring

Basics of DVD (Digital Video Disc) creation including media capturing, video and audio encoding, interface design, testing, and burning a sample DVD. Prerequisites: TCM136.

TCM290 3 credits 3 periods

Professional Media Marketing

Designed to equip media students with marketing tools for career development and promotion. Prerequisites: TCM136.

Course Modifications

The following are course modifications effective Summer 2006:

COMPUTER INFORMATION SYSTEMS CIS

CIS Department Office.....CM 404.....(480) 423-6588

CIS233AC 1 credit 2 periods

Internet Web Development: Dreamweaver Level I

Design and development of websites using Dreamweaver. Hands-on experience designing, developing, testing, and publishing web documents that contain client-side web technologies. Prerequisites: CIS133CA, or CIS133DA, or permission of instructor.

The following are course modifications effective Fall 2006:

ADMINISTRATION OF JUSTICE STUDIES AJS

Applied Sciences Division OfficeAP 237B.....(480) 423-6599

AJS101 3 credits 3 periods

Introduction to Criminal Justice

An introduction to crime and society's responses to it. Examines the nature and causes of crime, the criminal law, constitutional safeguards, and the organization and operation of the criminal justice system including the police, courts, jails, prisons, probation and parole departments, and community corrections agencies. Covers the history of the criminal justice system, terminology and career opportunities. Prerequisites: None.

ART/ADVERTISING ART ART/ADA

Art Department OfficeAB 112.....(480) 423-6344

Fine Arts Division Office.....MB 139.....(480) 423-6328

ART234 3 credits 6 periods

Color Photography I

Basic principles of color theory, camera and input and output techniques using slide film or digital photography. Prerequisites: ART131, or ART142, or permission of instructor. *Course Note: Film or digital camera is required. (ART234 is not offered every semester.)*

ART290AA 1 credit 2 periods

Studio Art

Studio course for art majors allowing continuation in a subject field. Prerequisites: Permission of instructor. *Course Note: ART290AA students must have completed advanced courses in the subject field.*

ART290AB 2 credits 4 periods

Studio Art

Studio course for art majors allowing continuation in a subject field. Prerequisites: Permission of instructor. *Course Note: ART290AB students must have completed advanced courses in the subject field.*

ART290AC 3 credits 6 periods

Studio Art (formerly ART290)

Studio course for art majors allowing continuation in a subject field. Prerequisites: Permission of instructor. *Course Note: ART290AC students must have completed advanced courses in the subject field.*

CHEMISTRY CHM

Mathematics/Sciences Division.....PS 153.....(480) 423-6111

CHM150 4 credits 4 periods

General Chemistry I

A detailed study of the principles of chemistry. *Completion of CHM151LL required to meet the Natural Science requirement.* Prerequisites: (CHM130 and CHM130LL) or (one year of high school chemistry with a grade of "C" or better taken within the last five years), and completion of intermediate algebra or equivalent. Completion of CHM130 and CHM130LL within the last two years recommended. *Course Note: CHM150 is designed for science majors and students in preprofessional curricula. Students may receive credit for only one of the following: CHM150 or CHM151.*

CHM151 3 credits 3 periods

General Chemistry I

A detailed study of the principles of chemistry. Designed for science majors and students in pre-professional curricula. *Completion of CHM151LL required to meet the Natural Science requirement.* Prerequisites: (CHM130 and CHM130LL) or (one year of high school chemistry with a grade of "C" or better taken within the last five years), and completion of intermediate algebra or equivalent. Completion of CHM130 and CHM130LL within the last two years recommended. *Course Note: Students may receive credit for only one of the following: CHM150 or CHM151.*

CHM151LL 1 credit 3 periods

General Chemistry I Laboratory

Laboratory experience in support of CHM150 or CHM151. Prerequisites: CHM130LL or equivalent. Prerequisites or Corequisites: CHM150 or CHM151.

CHM152 3 credits 3 periods

General Chemistry II

A study of the chemical properties of the major groups of elements, equilibrium theory, thermodynamics, electrochemistry, and other selected topics. Completion of CHM152LL required to meet the Natural Science requirement. Prerequisites: CHM150 or CHM151 and CHM151LL. Completion of CHM150 or CHM151 and CHM151LL within the last two years recommended.

CHM154 3 credits 3 periods

General Chemistry II with Qualitative Analysis

A study of the chemical properties of the major groups of elements, equilibrium theory, thermodynamics, kinetics, electrochemistry and other selected topics. Includes qualitative analysis. Prepares students for all sophomore chemistry courses. Completion of CHM154LL required to meet the Natural Science requirement. Prerequisites: CHM150 or CHM151 and CHM151LL. Completion of CHM150 or CHM151 and CHM151LL within the last two years recommended.

Course Descriptions

CHM230 3 credits 3 periods

Fundamental Organic Chemistry

Chemistry of representative groups of organic compounds, emphasizing biological applications. Prerequisites: (CHM130 and CHM130LL) or (CHM150 or CHM151 and CHM151LL). Completion of (CHM130 and CHM130LL) or (CHM150 or CHM151 and CHM151LL) within the last two years recommended. *Course Note: Course content designed to meet the needs of students in agriculture, home economics, nursing, pre-physician assistant, and physical education among others.*

CHM235 3 credits 3 periods

General Organic Chemistry I

Rigorous introduction to chemistry of carbon-containing compounds. Reaction mechanisms and recent methods of synthesis emphasized. Prerequisites: CHM152 and CHM152LL, or CHM154 and CHM154LL. Completion of (CHM152 and CHM152LL) or (CHM154 and CHM154LL) within the last two years recommended.

CHM236 3 credits 3 periods

General Organic Chemistry IIA

Study of chemistry of carbon-containing compounds continued. Structural determination and additional reaction mechanisms and modern methods of synthesis emphasized. Prerequisites: CHM235 and CHM235LL. Completion of CHM235 and CHM235LL within the last two years is recommended.

COMPUTER INFORMATION SYSTEMS CIS

CIS Department Office.....CM 404.....(480) 423-6588

CIS250 3 credits 4 periods

Management of Information Systems

The study of business information systems and its management, communication, e-business strategies, emerging technologies, database concepts, and project management. Overview of systems analysis and design. Learn about the competitive and strategic uses of information systems and how they are transforming organizations and their management. Prerequisites: CIS105.

CULINARY ARTS CUL

Hospitality, Tourism and Culinary Arts

Division Office AP 253.....(480) 423-6578

CUL120 2 credits 2 periods

Food Costing, Purchasing and Inventory Control (formerly CUL126)

Basic skills necessary to understand and utilize cost controls. Focus on measurements, recipe costing and yield analysis. Application of systems and practices for efficient food purchasing, storage, production, budgeting and inventory. Prerequisites: None.

CUL220 2 credits 2 periods

Food Service Nutrition (formerly CUL110)

Study of basic nutrition concepts with an emphasis on the nutritional concerns of restaurants and other types of food service operations. Focuses on nutrients in foods, the relationships to other nutrients and the planning of well-balanced menus throughout the life cycle. Prerequisites: None.

ENGLISH AS A SECOND LANGUAGE ESL

Language/Communication Division LC 305.....(480) 423-6459

ENG107 3 credits 3 periods

First-Year Composition for ESL

Equivalent of ENG101 for students of English as a Second Language (ESL). Emphasis on rhetoric and composition with a focus on expository writing and understanding writing as a process. Establishing effective college-level writing strategies through four or more writing projects comprising at least 3,000 words in total. Prerequisites: Appropriate ASSET/COMPASS placement test score, or a grade of "C" or better in ENG071 or ESL077. *Course Note: Through four or more writing projects comprising at least 3,000 words in total, the student will demonstrate an understanding of writing as a process per the course competencies.*

ENG108 3 credits 3 periods

First-Year Composition for ESL

Equivalent of ENG102 for students of English as a Second Language. Emphasis on rhetoric and composition with a focus on persuasive, research-based writing and understanding as a process. Developing advanced college-level writing strategies through three or more writing projects comprising at least 4,000 words in total. Prerequisites: Grade of "C" or better in ENG107. *Course Note: Through three or more writing projects comprising at least 4,000 words in total, the student will demonstrate an understanding of writing as a process per the course competencies. Not open to students who have completed ENG101.*

EDUCATION PROFESSIONAL DEVELOPMENT EPD

Social/Behavioral Sciences DivisionSB 130.....(480) 423-6206

EPD247 3 credits 3 periods

Practicum for English as a Second Language (ESL)/ Bilingual Teachers

Provides an opportunity to receive guided practical, on-site experience working with English Language Learners (ELL). Requires observations of ELL students in a variety of settings, evaluation of teaching techniques, and critical review of academic standards as they relate to English as a Second Language (ESL) learners. Prerequisites: (EDU/EPD220 or EDU225), or EDU230, or ENG213, or (EDU228 or EDU/EPD233 or EDU240 or EDU241), and provisional or standard elementary, secondary or special education teaching certificate.

EQUINE SCIENCE EQS

Applied Sciences Division Office AP 237B.....(480) 423-6599

EQS280 2 credits 10 periods

Equine Science Internship

Equine industry work experience in the area of choice. May include any type of departmentally approved equine facility or equine-related business. Prerequisites: Completion of all 100-level EQS courses and EQS250. *Course Note: EQS280 may be repeated for a total of four (4) credits with department permission.*

Course Descriptions

BUSINESS

Business Division Office AP 237A.....(480) 423-6253

GBS and SBU

GBS

Business

GBS221 3 credits 3 periods

Business Statistics

Business applications of descriptive and inferential statistics, measurement of relationships, and statistical process management. Includes the use of spreadsheet software for business statistical analysis. Prerequisites: Grade of "C" or better in GBS220.

PSYCHOLOGY

PSY

Social/Behavioral Sciences Division.....SB 130.....(480) 423-6206

PSY277 3 credits 3 periods

Psychology of Human Sexuality

Survey of psychological and physiological aspects of human sexual behavior. Emphasis placed on the integration of the cognitive, emotional, and behavioral factors in sexual functioning. Prerequisites: PSY101 with a grade of "C" or better, or permission of instructor. Student must be 18 years or older.

SOCIOLOGY

SOC

Social/Behavioral Sciences DivisionSB 130.....(480) 423-6206

SOC140 3 credits 3 periods

Racial and Ethnic Minorities

Contemporary/historical racial and ethnic intergroup relations emphasizing cultural origins, developments, and problems of minority groups in the United States. Prerequisites: None.

MOTION PICTURE/TELEVISION PRODUCTION TCM

MP/TV Department Office..... LC 305.....(480) 423-6076
Fine Arts Division Office..... MB 139.....(480) 423-6328

TCM215 3 credits 3 periods

Cinematography

Intermediate workshop focusing on 16mm film and digital video camera operation and lighting. Emphasis on the role of the cinematographer, camera operation and lens selection, interpreting the script, lighting, exposure meters, film stocks, and the aesthetics of editing. Shoot one short project and crew on two additional projects. Prerequisites: TCM136 or permission of instructor.

TCM245 4 credits 6 periods

Advanced Motion Picture Production

Advanced workshop in the production of the short narrative. Uses small production teams to pre-produce and shoot narrative movies on either film or digital platforms. Emphasizes the aesthetics and technical elements of scriptwriting, directing actors, directing crew, pre-production, camera and sound equipment operation, lighting, cinematography, production sound and final production. Prerequisites: (TCM120 and TCM215) or permission of instructor. *Course Note: TCM245 may be repeated for a total of twelve (12) credits.*

TCM250 4 credits 8 periods

Documentaries for Social Change

Study of and practical application in social documentary production. Focuses on diverse voices and styles of social documentaries, philosophical issues faced by the social documentary filmmaker, technical considerations in making a social documentary, and business elements required for financial and commercial success of the social documentary. Students view diverse social documentaries, participate in a variety of social documentary camera and sound exercises, complete an individual social documentary project on film and/or digital, and create a business proposal for their project. Prerequisites: TCM241, or TCM241AA, or TCM241AB, or permission of instructor. *Course Note: TCM250 may be repeated for a total of twelve (12) credits.*

TCM271 4 credits 6 periods

Advanced Non-Linear Effects and Compositing

Advanced non-linear techniques for effects and compositing creation. Prerequisites: (TCM241AA and TCM242) or permission of instructor.

TCM271AA 4 credits 6 periods

Advanced Non-Linear Effects and Compositing: AVID

Advanced non-linear techniques for effects and compositing creation. Prerequisites: (TCM241AA and TCM242) or permission of instructor.

TCM271AB 4 credits 6 periods

Advanced Non-Linear Effects and Compositing: Final Cut Pro

Advanced non-linear techniques for effects and compositing creation. Prerequisites: (TCM241AA and TCM242) or permission of instructor.

The following are course modifications effective Spring 2007:

ECONOMICS

ECN

Social/Behavioral Sciences DivisionSB 130.....(480) 423-6206

ECN211 3 credits 3 periods

Macroeconomic Principles (formerly ECN111)

A descriptive analysis of the structure and functioning of the American economy. Emphasis on basic economic institutions and factors that determine national income and employment levels. Consideration given to the macroeconomic topics of national income, unemployment, inflation and monetary and fiscal policies. Prerequisites: None.

ECN212 3 credits 3 periods

Microeconomic Principles (formerly ECN112)

Microeconomic analysis including the theory of consumer choice, price determination, resource allocation and income distribution. Includes noncompetitive market structures such as monopoly and oligopoly; and the effects of government regulation. Prerequisites: None.

Course Descriptions

EDUCATION PROFESSIONAL DEVELOPMENT EPD

Social/Behavioral Sciences DivisionSB 130.....(480) 423-6206

EPD275 3 credits 3 periods

Diagnosis and Remediation of Reading K-12 (formerly EDU275)

Fundamentals of diagnosis and remediation of reading problems for K-12. Administration, analysis and interpretation of informal diagnostic procedures and use of assessment results in planning a program of remediation. The Diagnostic Teaching of Reading emphasized. Prerequisites: EDU270AA or EDU270AB, and must hold a provisional or standard elementary, secondary or special education teaching certificate.

EPD279 3 credits 4.5 periods

Reading Practicum K-12 (formerly EDU279)

Focus on the practical application of current philosophical theories, methods, and models of assessment and instruction for remediation of reading. Prerequisites: EDU270AA or EDU270AB, and must hold a provisional or standard elementary, secondary or special education teaching certificate.

FIRE SCIENCE TECHNOLOGY FSC

Health Sciences Division OfficeSB 132.....(480) 423-6225

FSC110 3 credits 3 periods

Wildland Firefighter

Basic-level course for individuals with little or no experience in the wildland environment. Preparation for performing as a beginning-level wildland firefighter with an organized fire department engine or hand crew. Prerequisites: None.

MATHEMATICS MAT

Mathematics/Sciences DivisionPS 153..... (480) 423-6111

MAT220 5 credits 5 periods

Calculus with Analytic Geometry I

Limits, continuity, differential and integral calculus of functions of one variable. Prerequisites: Grade of "C" or better in (MAT150 or MAT151 or MAT152 and MAT182) or MAT187 or equivalent, or satisfactory score on district placement exam. *Course Note: Students may receive credit for only one of the following: MAT220 or MAT221.*

MAT230 5 credits 5 periods

Calculus with Analytic Geometry II

Techniques of integration for both proper and improper integrals with applications to the physical and social sciences, elements of analytic geometry, and the analysis of sequences and series. Prerequisites: Grade of "C" or better in MAT220 or MAT221 or equivalent. *Course Note: Students may receive credit for only one of the following: MAT230 or MAT231.*

MAT240 5 credits 5 periods

Calculus with Analytic Geometry III

Multivariate calculus including vectors, vector-valued functions, partial differentiation, multiple integration, and an introduction to vector fields. Prerequisites: Grade of "C" or better in MAT230 or MAT231. *Course Note: Students may receive credit for only one of the following: MAT240 or MAT241.*

MAT241 4 credits 4 periods

Calculus with Analytic Geometry III

Multivariate calculus including vectors, vector-valued functions, partial differentiation, multiple integration, and an introduction to vector fields. Prerequisites: Grade of "C" or better in MAT230 or MAT231. *Course Note: Students may receive credit for only one of the following: MAT240 or MAT241.*

MOTION PICTURE/TELEVISION PRODUCTION TCM

MP/TV Department Office LC 305..... (480) 423-6076

Fine Arts Division Office MB 139.....(480) 423-6328

TCM240 3 credits 3 periods

Advanced Television Commercial Production

Advanced workshop in television production. Emphasis on directing techniques, working with a crew, shooting and sound for advertising commercials. Prerequisites: TCM180 or permission of instructor.

TCM242 2 credits 4 periods

Portfolio Non-Linear Editing

Explores techniques and applications used in editing an individual project on a non-linear editing system. Prerequisites: TCM241, or TCM241AA, or TCM241AB, and independent footage. *Course Note: TCM242 may be repeated for a total of six (6) credits.*

TCM260 3 credits 4 periods

Film/Video Producing and Financing

Guides the independent film/video producer through basic business aspects of production. Examines methods of setting up a production company, strategies for financing and distribution, and approaches to "packaging" a film/video project. Includes development of a prospectus on a specific film/video project. Prerequisites: None.

TCM280 3 credits 5 periods

The Art of Editing

A lab intensive post-production course. Emphasizes the art of editing movie and television media and the development of editing skills. Editing products, including demo reels, from instructor provided or student provided quality raw footage. Prerequisites: TCM241, or TCM241AA, or TCM241AB. *Course Note: TCM280 may be repeated for a total of nine (9) credits.*

ADMINISTRATION, MANAGEMENT & FACULTY

This section supplements the college personnel information in the 2006-2007 General Catalog, pages 237-242, and includes the following additions to the faculty and faculty emeritus information:

New Faculty

BENTON, CHRISTOPHER (2006) B.S., University of Texas; M.S., Ph.D., University of Houston	Instructor, Mathematics
BOHART, JENNIFER (2006) B.A., Texas Tech. University; M.N.S., Arizona State University	Instructor, Mathematics
DeFALCO, NICHOLAS (2005) B.S.N., Grand Canyon University; M.S.N., University of Phoenix	Instructor, Nursing
KNAPP, JULIE (2006) B.A.S.E., M.A., Arizona State University	Instructor, English/Journalism

New Faculty Emeritus

Worth, Keith A., A.A.S., B.S.E.E.T., M.S.